

Regulator - TinyPower™, Buck-Boost, 2.5 A, I²C FAN49103



WLCSP20 2.015x1.615x0.586
CASE 567QK

Description

The FAN49103 is a high efficiency buck–boost switching mode regulator which accepts input voltages either above or below the regulated output voltage. Using full–bridge architecture with synchronous rectification, the FAN49103 is capable of delivering up to 2.5 A while regulating the output at 3.4 V. The FAN49103 exhibits seamless transition between step–up and step–down modes reducing output disturbances. The output voltage and operation mode of the regulator can be programmed through an I²C interface.

At moderate and light loads, Pulse Frequency Modulation (PFM) is used to operate the device in power–save mode to maintain high efficiency. In PFM mode, the part still exhibits excellent transient response during load steps. At moderate to heavier loads or Forced PWM mode, the regulator switches to PWM fixed–frequency control. While in PWM mode, the regulator operates at a nominal fixed frequency of 1.8 MHz, which allows for reduced external component values.

The FAN49103 is available in a 20–bump 1.615 mm x 2.015 mm with 0.4 mm pitch WLCSP.

Features

- 24 μA Typical PFM Quiescent Current
- Above 95% Efficiency
- Total Layout Area = 11.61 mm²
- Input Voltage Range: 2.5 V to 5.5 V
- Maximum Continuous Load Current:
 - ◆ 3.0 A at V_{OUT} = 3.4 V, V_{IN} = 3.3 V
 - ◆ 2.5 A at V_{OUT} = 3.4 V, V_{IN} = 3.0 V
 - ◆ 2.0 A at V_{OUT} = 3.4 V, V_{IN} = 2.5 V
- I²C Compatible Interface
- Programmable Output Voltage:
 - ◆ 2.5 V to 2.8 V in 50 mV Steps
 - ◆ 2.8 V to 4.0 V in 25 mV Steps
- 1.8 MHz Fixed–Frequency Operation in PWM Mode
- Automatic / Seamless Step–up and Step–down Mode Transitions
- Forced PWM and Automatic PFM/PWM Mode Selection
- 0.5 μA Typical Shutdown Current
- Low Quiescent Current Pass–Through Mode
- Internal Soft–Start and Output Discharge
- Low Ripple and Excellent Transient Response
- Internally Set, Automatic Safety Protections (UVLO, OTP, SCP, OCP)
- Package: 20 Bump, 0.4 mm Pitch WLCSP

Applications

- Smart Phones
- Portable Devices with Li–ion Battery
- 2G/3G/4G Power Amplifiers
- NFC Applications

MARKING DIAGRAM

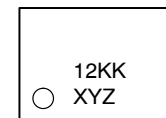

- 12 = Alphanumeric Device Marking
- KK = Lot Run Code
- X = Alphabetical Year Code
- Y = 2–weeks Date Code
- Z = Assembly Plant Code

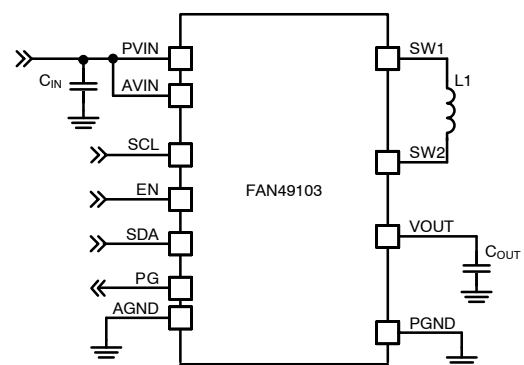

Figure 1. Typical Application

ORDERING INFORMATION

See detailed ordering and shipping information on page 2 of this data sheet.

FAN49103

ORDERING INFORMATION

Part Number	Default VOUT	Output Discharge	Slave Address	Temperature Range	Package	Packing Method†	Device Marking
FAN49103AUC340X	3.4 V	Yes	7h'70	-40 to 85°C	20-Ball (WLCSP)	Tape and Reel	FF
FAN49103AUC330X	3.3 V	Yes	7h'70	-40 to 85°C	20-Ball (WLCSP)	Tape and Reel	KX
FAN49103AUC34AX	3.4 V	Yes	7h'71	-40 to 85°C	20-Ball (WLCSP)	Tape and Reel	MQ

†For information on tape and reel specifications, including part orientation and tape sizes, please refer to our Tape and Reel Packaging Specifications Brochure, BRD8011/D.

BLOCK DIAGRAM

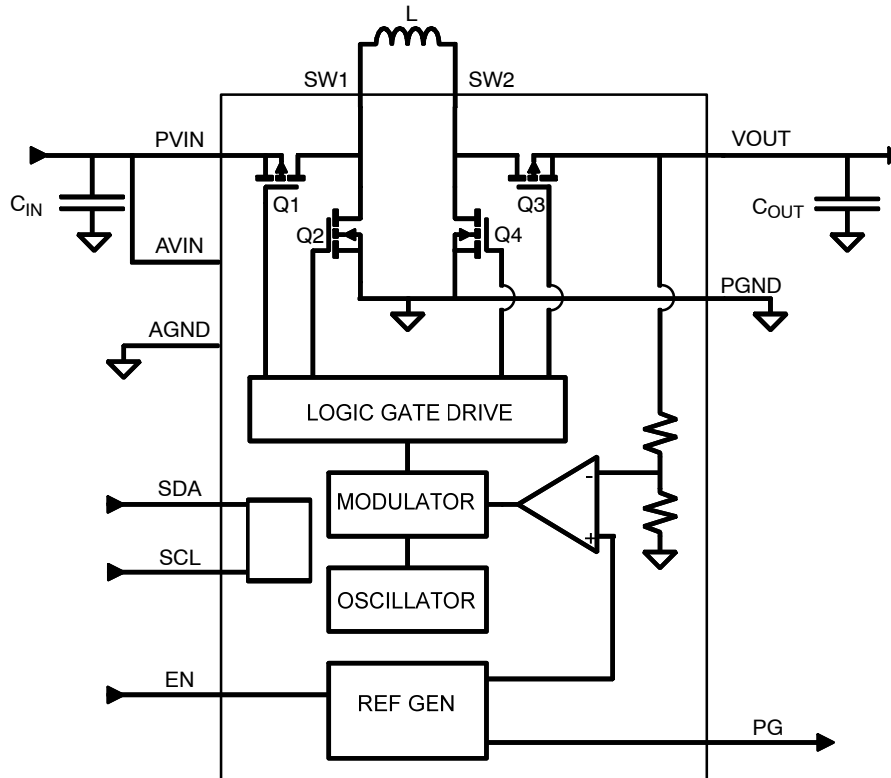

Figure 2. Block Diagram

FAN49103

PIN CONFIGURATION

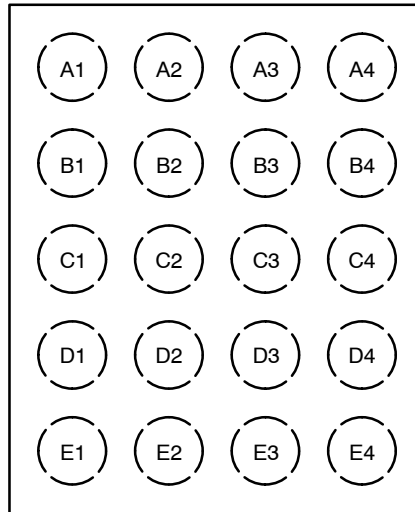

Figure 3. Top View (Bump Down)

PIN DEFINITIONS (Note 1)

Pin #	Name	Description
A3, A4	PVIN	Power Input Voltage. Connect to input power source. Connect to C_{IN} with minimal path
A1	AVIN	Analog Input Voltage. Analog input for device. Connect to C_{IN} and PVIN
A2	EN	Enable. A HIGH logic level on this pin forces the device to be enabled. A LOW logic level forces the device into shutdown. EN pin can be tied to VIN or driven via a GPIO logic voltage
B3, B4	SW1	Switching Node 1. Connect to inductor L1
E1	AGND	Analog Ground. Control block signal is referenced to this pin. Short AGND to PGND at GND pad of C_{OUT}
B1, C1, C2, C3, C4, D1	PGND	Power Ground. Low-side MOSFET of buck and main MOSFET of boost are referenced to this pin. C_{IN} and C_{OUT} should be returned with a minimal path to these pins
D2	SDA	I²C Data Line. Used for I ² C communication. If SDA is unused then tie pin to either AGND or PGND.
D3, D4	SW2	Switching Node 2. Connect to inductor L1
E2	PG	Power Good. This is an open-drain output and normally High Z. An external pull-up resistor from VOUT can be used to generate a logic HIGH. PG is pulled LOW if output falls out of regulation due to current overload or if thermal protection threshold is exceeded. If EN is LOW, PG is high impedance
B2	SCL	I²C Clock Line. Used for I ² C communication. If SCL is unused then tie pin to either AGND or PGND.
E3, E4	VOUT	Output Voltage. Buck-Boost Output. Connect to output load and C_{OUT}

1. Refer to Layout Recommendation section located near the end of the datasheet.

FAN49103

ABSOLUTE MAXIMUM RATINGS (T_A = 25°C, Unless otherwise specified)

Symbol	Parameter	Min	Max	Unit
PVIN/AVIN	PVIN/AVIN Voltage	-0.3	6.5	V
VOUT	VOUT Voltage	-0.3	6.5	V
SW1, SW2	SW Nodes Voltage	-0.3	7.0	V
	Other Pins	-0.3	6.5	V
ESD	Electrostatic Discharge Protection Level	Human Body Model per JESD22-A114	2000	V
		Charged Device Model per JESD22-C101	1000	
T _J	Junction Temperature	-40	+150	°C
T _{STG}	Storage Temperature	-65	+150	°C
T _L	Lead Soldering Temperature, 10 Seconds		+260	°C

Stresses exceeding those listed in the Maximum Ratings table may damage the device. If any of these limits are exceeded, device functionality should not be assumed, damage may occur and reliability may be affected.

RECOMMENDED OPERATING CONDITIONS

Symbol	Parameter	Min	Typ	Max	Unit
PVIN	Supply Voltage Range	2.5		5.5	V
I _{OUT}	Output Current (Note 2)	0		2.5	A
L	Inductor (Note 3)		1		μH
C _{OUT}	Output Capacitance (Note 3)		47		μF
T _A	Operating Ambient Temperature	-40		+85	°C
T _J	Operating Junction Temperature	-40		+125	°C

Functional operation above the stresses listed in the Recommended Operating Ranges is not implied. Extended exposure to stresses beyond the Recommended Operating Ranges limits may affect device reliability.

- Maximum current may be limited by the thermal conditions of the end application, PCB layout, and external component selection in addition to the device's thermal properties. Refer to the Application Information and Application Guidelines sections for more information.
- Refer to the Application Guidelines section for details on external component selection.

THERMAL PROPERTIES (Note 4, 5)

Symbol	Parameter	Min	Typ	Max	Unit
θ _{JA}	Junction-to-Ambient Thermal Resistance		66		°C/W

- Junction-to-ambient thermal resistance is a function of application and board layout. This data is measured with four-layer 2s2p with vias JEDEC class boards in accordance to JEDEC standard JESD51. Special attention must be paid not to exceed junction temperature T_{J(max)} at a given ambient temperature T_A.
- See Thermal Considerations in the Application Information section.

FAN49103

ELECTRICAL CHARACTERISTICS (Note 6, 7)

Minimum and maximum values are at $PV_{IN} = AV_{IN} = 2.5\text{ V}$ to 5.5 V , $VO_{UT} = 2.8\text{ V}$ to 4.0 V , $T_A = -40^\circ\text{C}$ to $+85^\circ\text{C}$. Typical values are at $T_A = 25^\circ\text{C}$, $PV_{IN} = AV_{IN} = V_{EN} = 3.6\text{ V}$, $VO_{UT} = 3.4\text{ V}$.

Symbol	Parameter	Conditions	Min	Typ	Max	Unit
--------	-----------	------------	-----	-----	-----	------

POWER SUPPLIES

I_Q	Quiescent Current	PFM Mode, $I_{OUT} = 0\text{ mA}$ (Note 8)		24		μA
		PT Mode, $I_{OUT} = 0\text{ mA}$		27		
I_{SD}	Shutdown Supply Current	$EN = \text{GND}$, $PV_{IN} = 3.6\text{ V}$		0.5	5.0	μA
V_{UVLO}	Under-Voltage Lockout Threshold	Falling PV_{IN}	1.95	2.00	2.05	V
V_{UVHYS}	Under-Voltage Lockout Hysteresis			200		mV

EN, SDA, SCL

V_{IH}	HIGH Level Input Voltage		1.1			V
V_{IL}	LOW Level Input Voltage				0.4	V
I_{IN}	Input Bias Current Into Pin	Input Tied to GND or PV_{IN}		0.01	1.00	μA

PG

V_{PG}	PG LOW	$I_{PG} = 5\text{ mA}$			0.4	V
I_{PG_LK}	PG Leakage Current	$V_{PG} = 5\text{ V}$			1	μA

SWITCHING

f_{SW}	Switching Frequency	$PV_{IN} = 3.6\text{ V}$, $T_A = 25^\circ\text{C}$	1.6	1.8	2.0	MHz
I_{p_LIM}	Peak PMOS Current Limit	$PV_{IN} = 3.6\text{ V}$	4.6	5.2	5.9	A

ACCURACY

V_{OUT_ACC}	DC Output Voltage Accuracy	$PV_{IN} = 3.6\text{ V}$, Forced PWM, $I_{OUT} = 0\text{ mA}$, $VO_{UT} = 3.4\text{ V}$	3.366	3.400	3.434	V
		$PV_{IN} = 3.6\text{ V}$, PFM Mode, $I_{OUT} = 0\text{ mA}$, $VO_{UT} = 3.4\text{ V}$	3.366	3.475	3.563	

Product parametric performance is indicated in the Electrical Characteristics for the listed test conditions, unless otherwise noted. Product performance may not be indicated by the Electrical Characteristics if operated under different conditions.

- Refer to Typical Characteristics waveforms/graphs for Closed-Loop data and its variation with input voltage and ambient temperature. Electrical Characteristics reflects Open-Loop steady state data. System Characteristics reflects both steady state and dynamic Close-Loop data associated with the recommended external components.
- Minimum and Maximum limits are verified by design, test, or statistical analysis. Typical (Typ.) values are not tested, but represent the parametric norm.
- Device is not switching.

FAN49103

SYSTEM CHARACTERISTICS

The following table is verified by design and bench test while using circuit of Figure 1 with the recommended external components. Typical values are at $T_A = 25^\circ\text{C}$, $PV_{IN} = AV_{IN} = V_{EN} = 3.6\text{ V}$, $V_{OUT} = 3.4\text{ V}$. These parameters are not verified in production.

Symbol	Parameter		Min	Typ	Max	Unit
V_{OUT_ACC}	Total Accuracy (Includes DC accuracy and load transient) (Note 9)			± 5		%
ΔV_{OUT}	Load Regulation	$I_{OUT} = 0.4\text{ A to } 2.5\text{ A}$, $PV_{IN} = 3.6\text{ V}$		-0.20		%/A
ΔV_{OUT}	Line Regulation	$3.0\text{ V} \leq PV_{IN} \leq 4.2\text{ V}$, $I_{OUT} = 1.5\text{ A}$		-0.06		%/V
V_{OUT_RIPPLE}	Ripple Voltage	$PV_{IN} = 4.2\text{ V}$, $V_{OUT} = 3.4\text{ V}$, $I_{OUT} = 1\text{ A}$, PWM Mode		4		mV
		$PV_{IN} = 3.6\text{ V}$, $V_{OUT} = 3.4\text{ V}$, $I_{OUT} = 100\text{ mA}$, PFM Mode		22		
		$PV_{IN} = 3.0\text{ V}$, $V_{OUT} = 3.4\text{ V}$, $I_{OUT} = 1\text{ A}$, PWM Mode		14		
η	Efficiency	$PV_{IN} = 3.0\text{ V}$, $V_{OUT} = 3.4\text{ V}$, $I_{OUT} = 50\text{ mA}$, PFM		90		%
		$PV_{IN} = 3.0\text{ V}$, $V_{OUT} = 3.4\text{ V}$, $I_{OUT} = 500\text{ mA}$, PWM		96		
		$PV_{IN} = 3.8\text{ V}$, $V_{OUT} = 3.4\text{ V}$, $I_{OUT} = 50\text{ mA}$, PFM		90		
		$PV_{IN} = 3.8\text{ V}$, $V_{OUT} = 3.4\text{ V}$, $I_{OUT} = 600\text{ mA}$, PWM		94		
		$PV_{IN} = 3.4\text{ V}$, $V_{OUT} = 3.4\text{ V}$, $I_{OUT} = 300\text{ mA}$, PWM		94		
T_{SS}	Soft-Start	EN HIGH to 95% of Target V_{OUT} , $I_{OUT} = 68\text{ mA}$		260		μs
ΔV_{OUT_LOAD}	Load Transient	$PV_{IN} = 3.4\text{ V}$, $I_{OUT} = 0.5\text{ A} \Leftrightarrow 1\text{ A}$, $TR = TF = 1\text{ }\mu\text{s}$		± 45		mV
		$PV_{IN} = 3.4\text{ V}$, $I_{OUT} = 0.5\text{ A} \Leftrightarrow 2.0\text{ A}$, $TR = TF = 1\text{ }\mu\text{s}$, Pulse Width = 577 μs		± 125		
ΔV_{OUT_LINE}	Line Transient	$PV_{IN} = 3.0\text{ V} \Leftrightarrow 3.6\text{ V}$, $TR = TF = 10\text{ }\mu\text{s}$, $I_{OUT} = 1\text{ A}$		± 60		mV

9. Load transient is from 0.5 A \Leftrightarrow 1 A.

TYPICAL CHARACTERISTICS

Unless otherwise noted, $P_{VIN} = A_{VIN} = V_{EN} = 3.6\text{ V}$, $V_{OUT} = 3.4\text{ V}$, circuit of Figure 1 with the recommended external components, AUTO Mode, $T_A = 25^\circ\text{C}$.

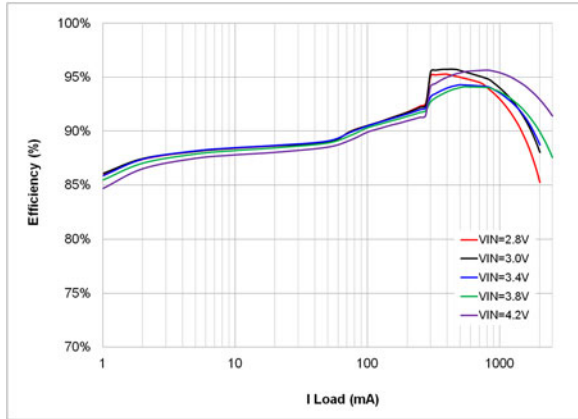

Figure 4. Efficiency vs. Load

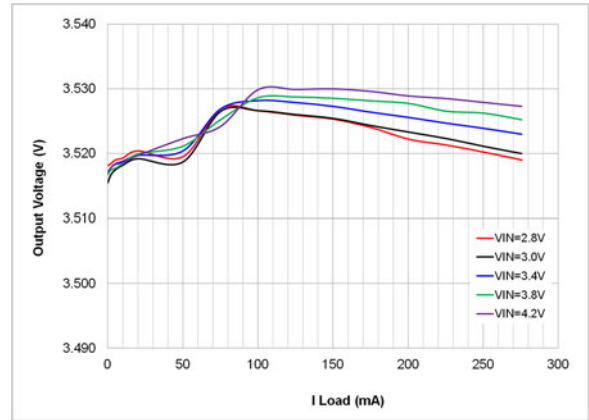

Figure 5. Output Regulation vs. Load

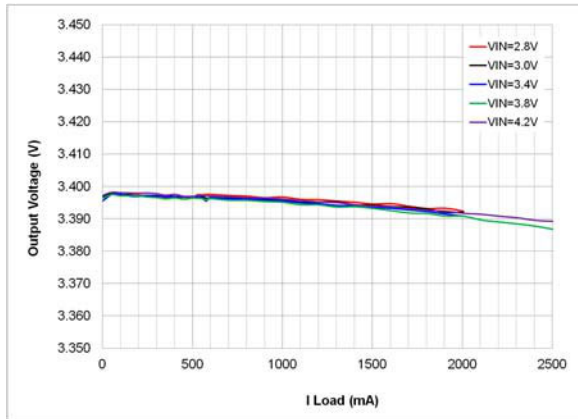

Figure 6. Output Regulation vs. Load, FPWM Mode

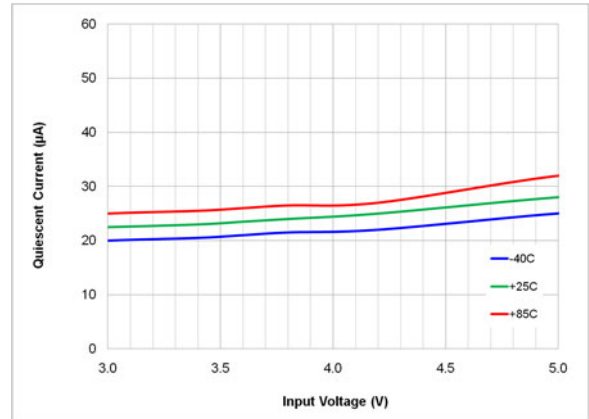

Figure 7. Quiescent Current (No Switching) vs. Input Voltage

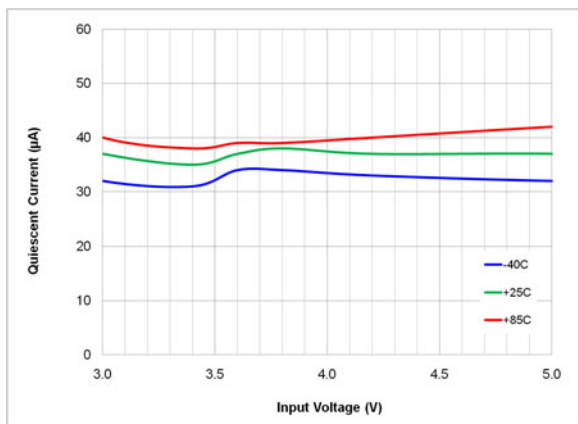

Figure 8. Quiescent Current (Switching) vs. Input Voltage

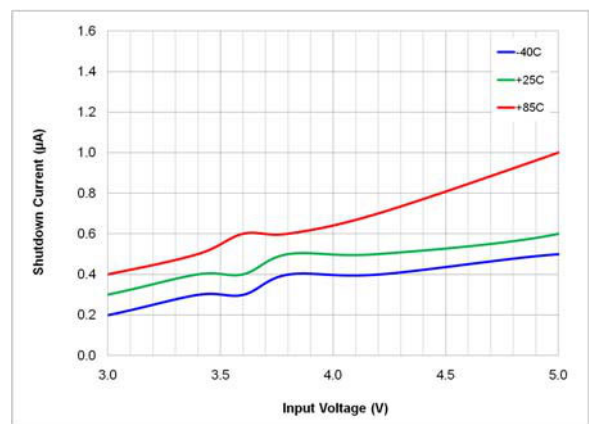

Figure 9. Shutdown Current vs. Input Voltage

TYPICAL CHARACTERISTICS

Unless otherwise noted, $P_{VIN} = A_{VIN} = V_{EN} = 3.6\text{ V}$, $V_{OUT} = 3.4\text{ V}$, circuit of Figure 1 with the recommended external components, AUTO Mode, $T_A = 25^\circ\text{C}$.

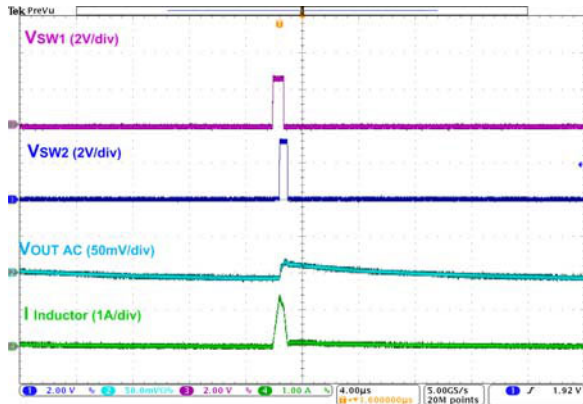

Figure 10. Output Ripple, $V_{IN} = 2.8\text{ V}$, $I_{OUT} = 20\text{ mA}$, Boost Operation

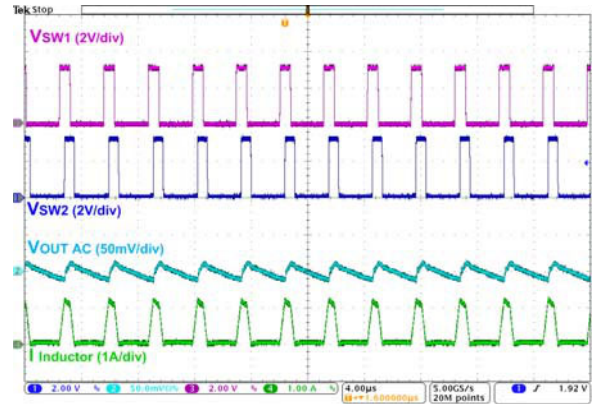

Figure 11. Output Ripple, $V_{IN} = 3.3\text{ V}$, $I_{OUT} = 200\text{ mA}$, Buck-Boost Operation

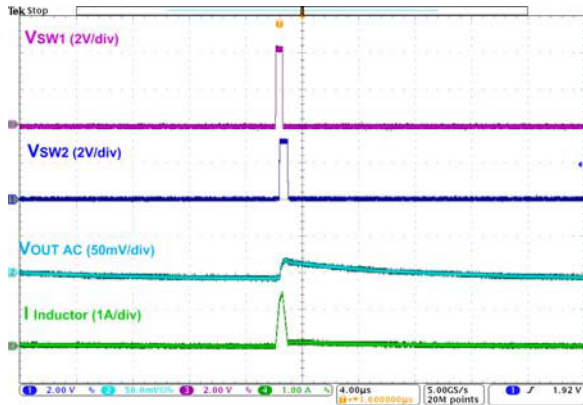

Figure 12. Output Ripple, $V_{IN} = 4.2\text{ V}$, $I_{OUT} = 20\text{ mA}$, Buck Operation

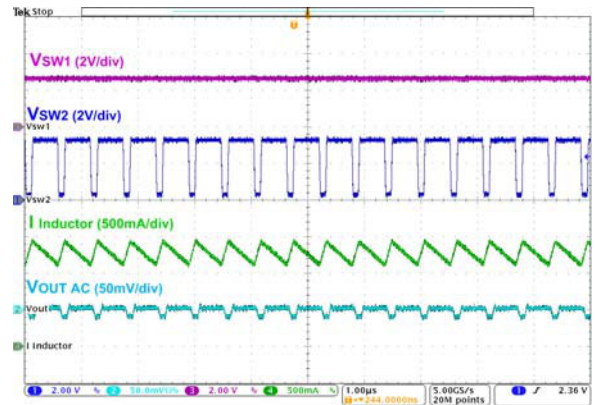

Figure 13. Output Ripple, $V_{IN} = 2.5\text{ V}$, $I_{OUT} = 1000\text{ mA}$, Boost Operation

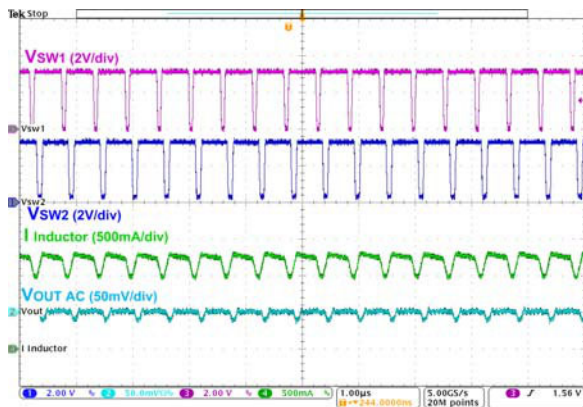

Figure 14. Output Ripple, $V_{IN} = 3.3\text{ V}$, $I_{OUT} = 1000\text{ mA}$, Buck-Boost Operation

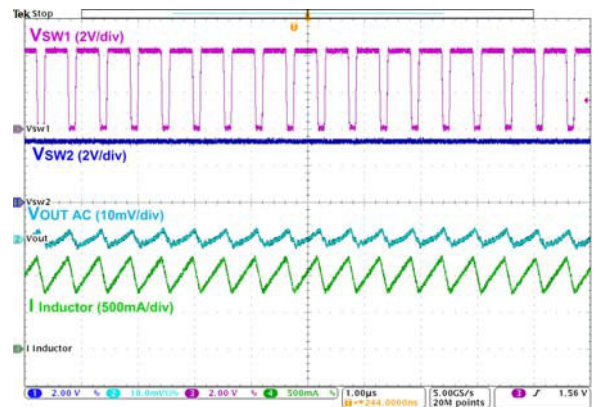

Figure 15. Output Ripple, $V_{IN} = 4.5\text{ V}$, $I_{OUT} = 1000\text{ mA}$, Buck Operation

FAN49103

TYPICAL CHARACTERISTICS

Unless otherwise noted, $P_{VIN} = A_{VIN} = V_{EN} = 3.6\text{ V}$, $V_{OUT} = 3.4\text{ V}$, circuit of Figure 1 with the recommended external components, AUTO Mode, $T_A = 25^\circ\text{C}$.

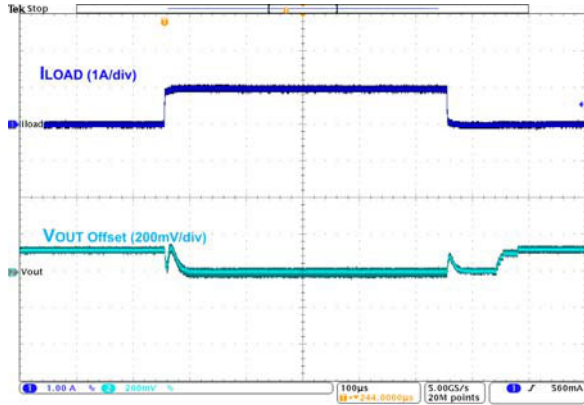

Figure 16. Load Transient, 0 mA \leftrightarrow 1000 mA, 1 ms Edge, $V_{IN} = 3.60\text{ V}$

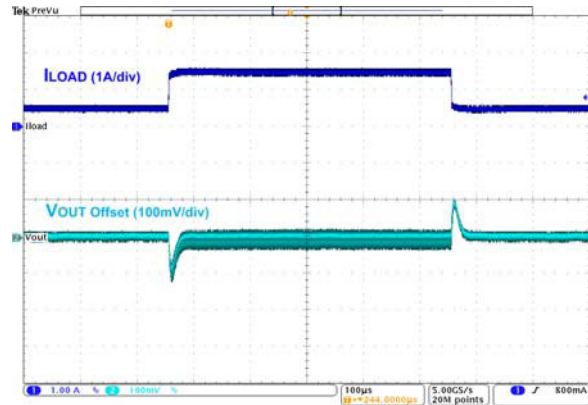

Figure 17. Load Transient, 500 mA \leftrightarrow 1500 mA, 1 ms Edge, $V_{IN} = 3.60\text{ V}$

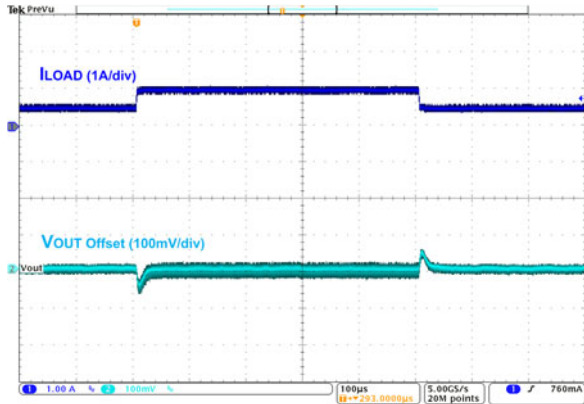

Figure 18. Load Transient, 500 mA \leftrightarrow 1000 mA, 1 ms Edge, $V_{IN} = 3.40\text{ V}$

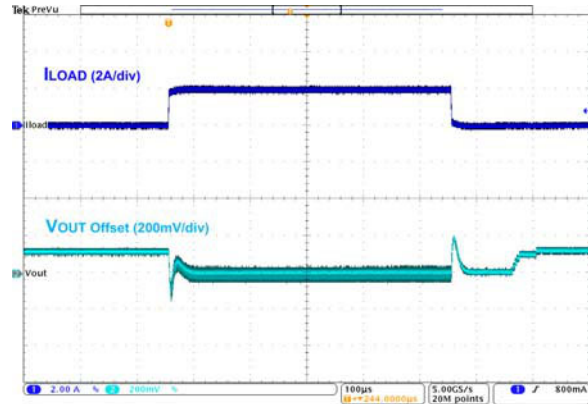

Figure 19. Load Transient, 0 mA \leftrightarrow 2000 mA, 1 ms Edge, $V_{IN} = 3.60\text{ V}$

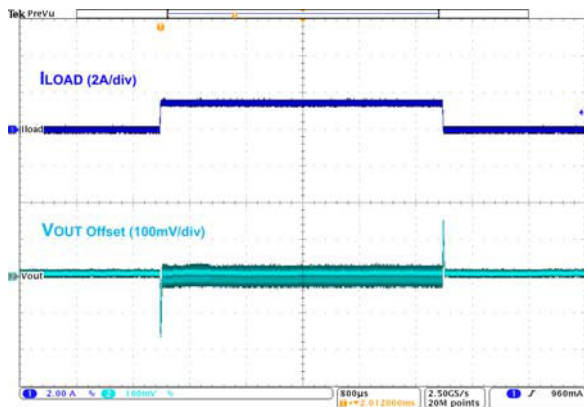

Figure 20. Load Transient, 0 mA \leftrightarrow 1500 mA, 10 ms Edge, $V_{IN} = 2.80\text{ V}$, PWM Mode

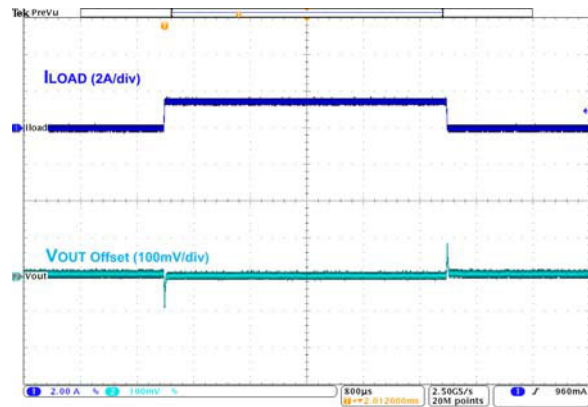

Figure 21. Load Transient, 0 mA \leftrightarrow 1500 mA, 10 ms Edge, $V_{IN} = 4.20\text{ V}$, PWM Mode

FAN49103

TYPICAL CHARACTERISTICS

Unless otherwise noted, $P_{VIN} = A_{VIN} = V_{EN} = 3.6\text{ V}$, $V_{OUT} = 3.4\text{ V}$, circuit of Figure 1 with the recommended external components, AUTO Mode, $T_A = 25^\circ\text{C}$.

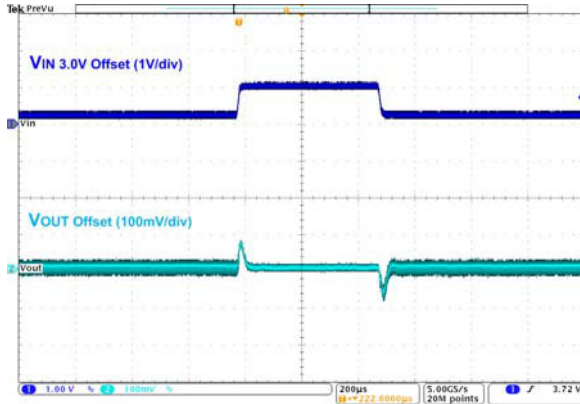

Figure 22. Line Transient, $3.2 \leftrightarrow 4.0\text{ VIN}$, 10 ms Edge, 1000 mA Load

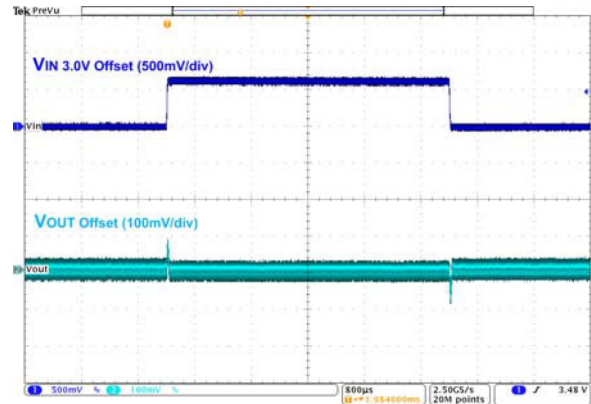

Figure 23. Line Transient, $3.0 \leftrightarrow 3.6\text{ VIN}$, 10 ms Edge, 1500 mA Load, PWM

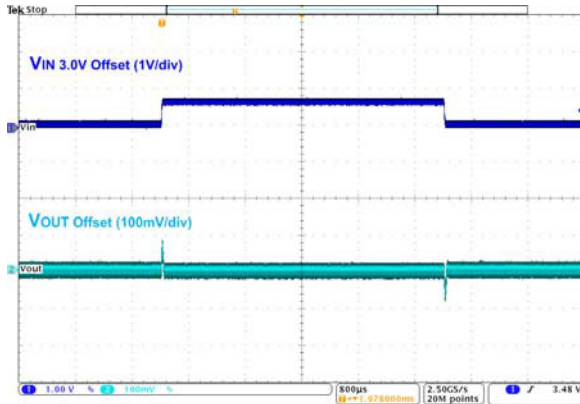

Figure 24. Line Transient, $3.0 \leftrightarrow 3.6\text{ VIN}$, 10 ms Edge, 1000 mA Load, PWM

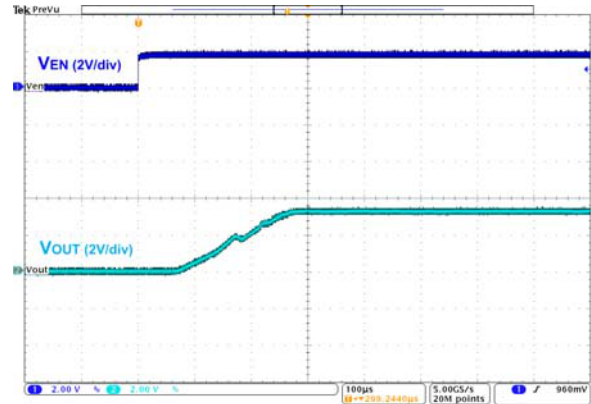

Figure 25. Startup, $V_{IN} = 3.6\text{ V}$, $I_{OUT} = 0\text{ mA}$

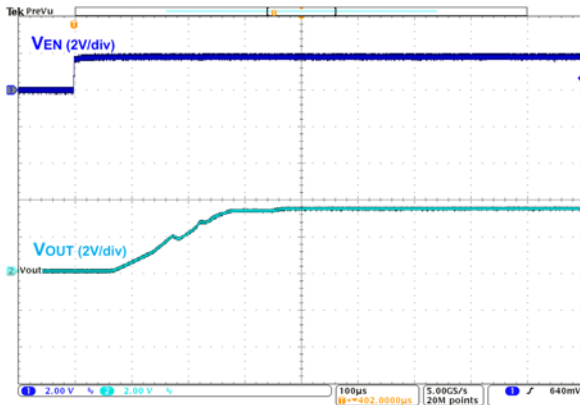

Figure 26. Startup, $V_{IN} = 3.6\text{ V}$, $I_{OUT} = 68\text{ mA}$

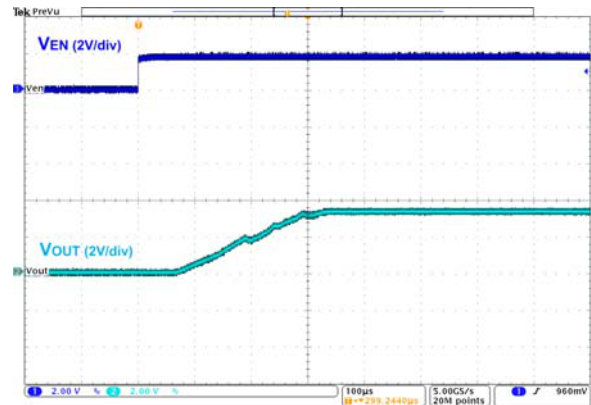

Figure 27. Startup, $V_{IN} = 3.6\text{ V}$, $I_{OUT} = 1000\text{ mA}$

FAN49103

TYPICAL CHARACTERISTICS

Unless otherwise noted, $P_{VIN} = A_{VIN} = V_{EN} = 3.6\text{ V}$, $V_{OUT} = 3.4\text{ V}$, circuit of Figure 1 with the recommended external components, AUTO Mode, $T_A = 25^\circ\text{C}$.

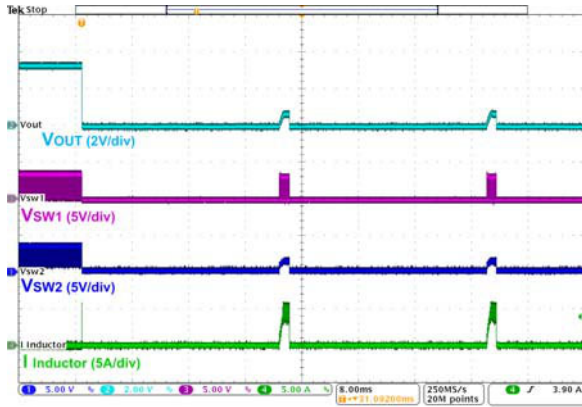

Figure 28. Short-Circuit Protection

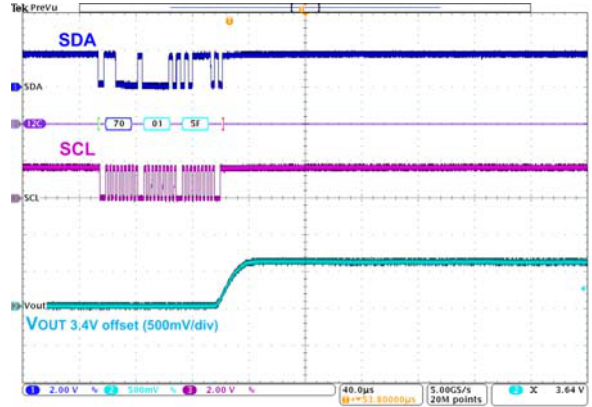

Figure 29. V_{OUT} Transition, $3.4\text{ V} \Leftrightarrow 4.0\text{ V}$,
500 mA Load

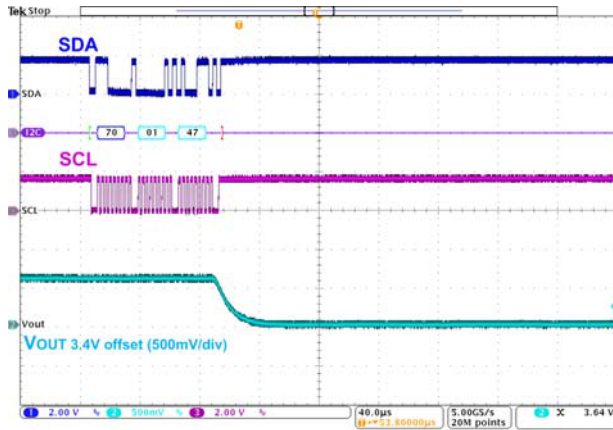

Figure 30. V_{OUT} Transition, $4.0\text{ V} \Leftrightarrow 3.4\text{ V}$,
500 mA Load

APPLICATION INFORMATION

Functional Description

FAN49103 is a fully integrated synchronous, full bridge DC-DC converter that can operate in buck operation (during high PVIN), boost operation (for low PVIN) and a combination of buck-boost operation when PVIN is close to the target VOUT value. The PWM/PFM controller switches automatically and seamlessly between buck, buck-boost and boost modes.

The FAN49103 uses a four-switch operation during each switching period when in the buck-boost mode. Mode operation is as follows: referring to the power drive stage

shown in Figure 31 if PVIN is greater than target VOUT, then the converter is in buck mode: Q3 is ON and Q4 is OFF continuously leaving Q1, Q2 to operate as a current-mode controlled PWM converter. If PVIN is lower than target VOUT then the converter is in boost mode with Q1 ON and Q2 OFF continuously, while leaving Q3, Q4 to operate as a current-mode boost converter. When PVIN is near VOUT, the converter goes into a 3-phase operation in which combines a buck phase, a boost phase and a reset phase; all switches are switching to maintain an average inductor volt-second balance.

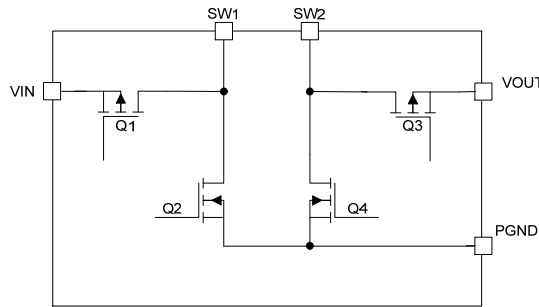

Figure 31. Simplified Block Diagram

PFM/PWM Mode

The FAN49103 uses a current-mode modulator to achieve smooth transitions between PWM and PFM operation. In Pulsed Frequency Modulation (PFM), frequency is reduced to maintain high efficiency. During PFM operation, the converter positions the output voltage typically 75 mV higher than the nominal output voltage during PWM operation, allowing additional headroom for voltage drop during a load transient from light to heavy load. As the load increased from light loads, the converter enters PWM operation typically at 300 mA of current load. The converter switching frequency is typically 1.8 MHz during PWM operation for moderate to heavy load currents.

PT (Pass-Through) Mode

In Pass-Through mode, all of the switches are not switching and VOUT tracks PVIN ($V_{OUT} = V_{IN} - I_{OUT} \times (Q1_{RDSON} + Q3_{RDSON} + L_{DCR})$). In PT mode only Over-Temperature (OTP) and Under Voltage Lockout (UVLO) protection circuits are activated. There is no Over-Current Protection (OCP) in PT mode.

Shutdown and Startup

When the EN pin is LOW, the IC is in Shutdown mode and non-essential internal circuits are off. In this state, I²C can be written to or read from. During shutdown, VOUT is isolated from PVIN. Raising EN pin activates the device and begins the soft-start cycle. During soft-start, the modulator’s internal reference is ramped slowly to minimize surge currents on the input and prevent overshoot of the

output voltage. If VOUT fails to reach target VOUT value after 1 ms, a FAULT condition is declared.

Over-Temperature (OTP)

The regulator shuts down when the die temperature exceeds 150°C. Restart occurs when the IC has cooled by approximately 20°C.

Output Discharge

When the regulator is disabled and driving the EN pin LOW, a 230 Ω internal resistor is activated between VOUT and GND. The Output Discharge is not activated during a FAULT state condition.

Over-Current Protection (OCP)

If the peak current limit is activated for a typical 700 μs, a FAULT state is generated, so that the IC protects itself as well as external components and load.

FAULT State

The regulator enters the FAULT state under any of the following conditions:

- VOUT fails to achieve the voltage required after soft-start
- Peak current limit triggers
- OTP or UVLO are triggered

Once a FAULT is triggered, the regulator stops switching and presents a high-impedance path between PVIN and VOUT. After waiting 30 ms, a restart is attempted.

Power Good

PG, an open–drain output, is LOW during FAULT state and HIGH for Power Good.

The PG pin is provided for signaling the system when the regulator has successfully completed soft–start and no FAULTs have occurred. PG pin also functions as a warning flag for high die temperature and overload conditions.

- PG is released HIGH when the soft–start sequence is successfully completed
- PG is pulled LOW when a FAULT is declared. Any FAULT condition causes PG to be de–asserted

Thermal Considerations

For best performance, the die temperature and the power dissipated should be kept at moderate values. The maximum power dissipated can be evaluated based on the following relationship:

$$P_{D(max)} = \left\{ \frac{T_{J(max)} - T_A}{\Theta_{JA}} \right\}$$

where $T_{J(max)}$ is the maximum allowable junction temperature of the die; T_A is the ambient operating temperature; and θ_{JA} is dependent on the surrounding PCB layout and can be improved by providing a heat sink of surrounding copper ground.

The addition of backside copper with through–holes, stiffeners, and other enhancements can help reduce θ_{JA} . The heat contributed by the dissipation of devices nearby must be included in design considerations. Following the layout recommendation may lower the θ_{JA} .

I²C Interface

The FAN49103’s serial interface is compatible with Standard, Fast, Fast Plus, and HS Mode I²C–Bus specifications. The SCL line is an input and its SDA line is a bi–directional open–drain output; it can only pull down the bus when active. The SDA line only pulls LOW during data reads and when signaling ACK. All data is shifted in MSB (bit 7) first.

I²C Slave Address

In hex notation, the slave address assumes a 0 LS Bit. The hex slave address is 8h'E0 (7h'70) for FAN49103AUC340X. See Ordering information for other address options.

Table 1. I²C SLAVE ADDRESS

Hex	Bits							R/W
	7	6	5	4	3	2	1	
E0	1	1	1	0	0	0	0	R/W

Bus Timing

As shown in Figure 32, data is normally transferred when SCL is LOW. Data is clocked in on the rising edge of SCL. Typically, data transitions shortly at or after the

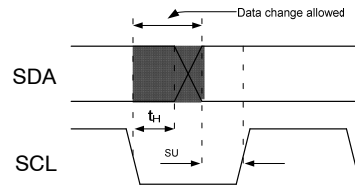

Figure 32. Data Transfer Timing

Each bus transaction begins and ends with SDA and SCL HIGH. A transaction begins with a START condition, which is defined as SDA transitioning from 1 to 0 with SCL HIGH, as shown in Figure 33.

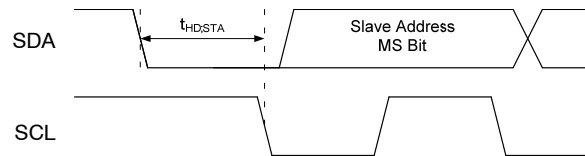

Figure 33. START Bit

A transaction ends with a STOP condition, which is defined as SDA transitioning from 0 to 1 with SCL HIGH, as shown in Figure 34.

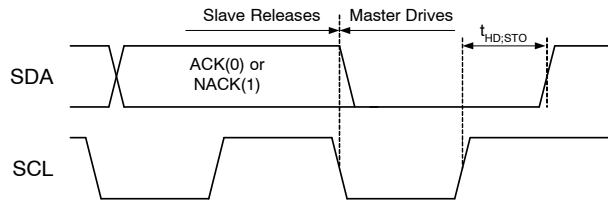

Figure 34. STOP Bit

During a read from the FAN49103, the master issues a REPEATED START after sending the register address, and before resending the slave address. The REPEATED START is a 1 to 0 transition on SDA while SCL is HIGH, as shown in Figure 35.

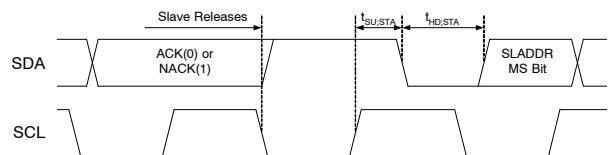

Figure 35. REPEATED START Bit

FAN49103

High-Speed (HS) Mode

The protocols for High-Speed (HS), Low-Speed (LS), and Fast-Speed (FS) Modes are identical; except the bus speed for HS mode is 3.4 MHz. HS Mode is entered when the bus master sends the HS master code 00001XXX after a START condition. The master code is sent in Fast or Fast-Plus Mode (less than 1 MHz clock); slaves do not ACK this transmission.

The master generates a REPEATED START condition (Figure 33) that causes all slaves on the bus to switch to HS Mode. The master then sends I2C packets, as described above, using the HS Mode clock rate and timing.

The bus remains in HS Mode until a STOP bit (Figure 34) is sent by the master. While in HS Mode, packets are separated by REPEATED START conditions (Figure 35).

Read and Write Transactions

The following figures outline the sequences for data read and write. Bus control is signified by the shading of the packet, defined as

Master Drives Bus

and

Slave Drives Bus

All addresses and data are MSB first.

Table 2. I²C BIT DEFINITIONS FOR FIGURE 36 & FIGURE 37

Symbol	Definition
R	REPEATED START, see Figure 35
P	STOP, see Figure 34
S	START, see Figure 33
A	ACK. The slave drives SDA to 0 to acknowledge the preceding packet
A	NACK. The slave sends a 1 to NACK the preceding packet
R	REPEATED START, see Figure 35
P	STOP, see Figure 34

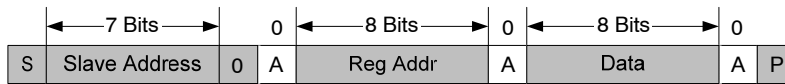

Figure 36. Write Transaction

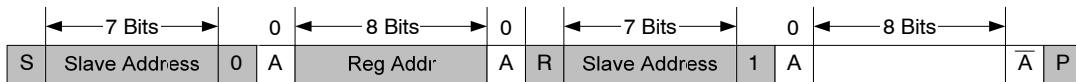

Figure 37. Read Transaction

Register Description

Table 3. REGISTER TABLE

Hex Address	Name	Function
01	VOUT_REF	Set the target regulation point of VOUT
02	CONTROL	PT and MODE control
40	Manufacturer_ID	Read-only register identifies vendor and device type
41	Device_ID	Read-only register identifies die ID

FAN49103

BIT DEFINITIONS

The following table defines the operation of each register bit. **Bold** indicates power-on default values.

Bit	Name	Value	Description																																																																																																																								
VOUT_REF R/W REGISTER ADDRESS: 01																																																																																																																											
7	Reserved	0																																																																																																																									
6:0	Ref_dac_code	0000000	<p>Sets the target regulation point for VOUT. By default, the bits will read back as all zeroes. When changing the VOUT target, do not write the Reserved values, including 00h. If the default VOUT voltage must be written, the device must be programmed to the non-reserved equivalent value.</p> <table border="1"> <thead> <tr> <th>HEX</th> <th>VOUT</th> <th>HEX</th> <th>VOUT</th> </tr> </thead> <tbody> <tr><td>00 – 28</td><td>Reserved</td><td>44</td><td>3.325</td></tr> <tr><td>29</td><td>2.500</td><td>45</td><td>3.350</td></tr> <tr><td>2A</td><td>2.550</td><td>46</td><td>3.375</td></tr> <tr><td>2B</td><td>2.600</td><td>47</td><td>3.400</td></tr> <tr><td>2C</td><td>2.650</td><td>48</td><td>3.425</td></tr> <tr><td>2D</td><td>2.700</td><td>49</td><td>3.450</td></tr> <tr><td>2E</td><td>2.750</td><td>4A</td><td>3.475</td></tr> <tr><td>2F</td><td>2.800</td><td>4B</td><td>3.500</td></tr> <tr><td>30</td><td>2.825</td><td>4C</td><td>3.525</td></tr> <tr><td>31</td><td>2.850</td><td>4D</td><td>3.550</td></tr> <tr><td>32</td><td>2.875</td><td>4E</td><td>3.575</td></tr> <tr><td>33</td><td>2.900</td><td>4F</td><td>3.600</td></tr> <tr><td>34</td><td>2.925</td><td>50</td><td>3.625</td></tr> <tr><td>35</td><td>2.950</td><td>51</td><td>3.650</td></tr> <tr><td>36</td><td>2.975</td><td>52</td><td>3.675</td></tr> <tr><td>37</td><td>3.000</td><td>53</td><td>3.700</td></tr> <tr><td>38</td><td>3.025</td><td>54</td><td>3.725</td></tr> <tr><td>39</td><td>3.050</td><td>55</td><td>3.750</td></tr> <tr><td>3A</td><td>3.075</td><td>56</td><td>3.775</td></tr> <tr><td>3B</td><td>3.100</td><td>57</td><td>3.800</td></tr> <tr><td>3C</td><td>3.125</td><td>58</td><td>3.825</td></tr> <tr><td>3D</td><td>3.150</td><td>59</td><td>3.850</td></tr> <tr><td>3E</td><td>3.175</td><td>5A</td><td>3.875</td></tr> <tr><td>3F</td><td>3.200</td><td>5B</td><td>3.900</td></tr> <tr><td>40</td><td>3.225</td><td>5C</td><td>3.925</td></tr> <tr><td>41</td><td>3.250</td><td>5D</td><td>3.950</td></tr> <tr><td>42</td><td>3.275</td><td>5E</td><td>3.975</td></tr> <tr><td>43</td><td>3.300</td><td>5F</td><td>4</td></tr> <tr><td></td><td></td><td>60 – 7F</td><td>Reserved</td></tr> </tbody> </table>	HEX	VOUT	HEX	VOUT	00 – 28	Reserved	44	3.325	29	2.500	45	3.350	2A	2.550	46	3.375	2B	2.600	47	3.400	2C	2.650	48	3.425	2D	2.700	49	3.450	2E	2.750	4A	3.475	2F	2.800	4B	3.500	30	2.825	4C	3.525	31	2.850	4D	3.550	32	2.875	4E	3.575	33	2.900	4F	3.600	34	2.925	50	3.625	35	2.950	51	3.650	36	2.975	52	3.675	37	3.000	53	3.700	38	3.025	54	3.725	39	3.050	55	3.750	3A	3.075	56	3.775	3B	3.100	57	3.800	3C	3.125	58	3.825	3D	3.150	59	3.850	3E	3.175	5A	3.875	3F	3.200	5B	3.900	40	3.225	5C	3.925	41	3.250	5D	3.950	42	3.275	5E	3.975	43	3.300	5F	4			60 – 7F	Reserved
HEX	VOUT	HEX	VOUT																																																																																																																								
00 – 28	Reserved	44	3.325																																																																																																																								
29	2.500	45	3.350																																																																																																																								
2A	2.550	46	3.375																																																																																																																								
2B	2.600	47	3.400																																																																																																																								
2C	2.650	48	3.425																																																																																																																								
2D	2.700	49	3.450																																																																																																																								
2E	2.750	4A	3.475																																																																																																																								
2F	2.800	4B	3.500																																																																																																																								
30	2.825	4C	3.525																																																																																																																								
31	2.850	4D	3.550																																																																																																																								
32	2.875	4E	3.575																																																																																																																								
33	2.900	4F	3.600																																																																																																																								
34	2.925	50	3.625																																																																																																																								
35	2.950	51	3.650																																																																																																																								
36	2.975	52	3.675																																																																																																																								
37	3.000	53	3.700																																																																																																																								
38	3.025	54	3.725																																																																																																																								
39	3.050	55	3.750																																																																																																																								
3A	3.075	56	3.775																																																																																																																								
3B	3.100	57	3.800																																																																																																																								
3C	3.125	58	3.825																																																																																																																								
3D	3.150	59	3.850																																																																																																																								
3E	3.175	5A	3.875																																																																																																																								
3F	3.200	5B	3.900																																																																																																																								
40	3.225	5C	3.925																																																																																																																								
41	3.250	5D	3.950																																																																																																																								
42	3.275	5E	3.975																																																																																																																								
43	3.300	5F	4																																																																																																																								
		60 – 7F	Reserved																																																																																																																								
CONTROL R/W REGISTER ADDRESS: 02																																																																																																																											
7:4	Reserved	0000																																																																																																																									
3	i2c_pt_in	0	<p>Enables Pass-Through mode.</p> <table border="1"> <thead> <tr> <th>Code</th> <th>Mode</th> </tr> </thead> <tbody> <tr><td>0</td><td>Regulated output (Boost, Buck or Buck-Boost)</td></tr> <tr><td>1</td><td>Pass-Through enabled</td></tr> </tbody> </table>	Code	Mode	0	Regulated output (Boost, Buck or Buck-Boost)	1	Pass-Through enabled																																																																																																																		
Code	Mode																																																																																																																										
0	Regulated output (Boost, Buck or Buck-Boost)																																																																																																																										
1	Pass-Through enabled																																																																																																																										
2	i2c_mode_in	0	<p>Enables Forced PWM mode, as long as Pass-Through is not enabled.</p> <table border="1"> <thead> <tr> <th>Code</th> <th>Mode</th> </tr> </thead> <tbody> <tr><td>0</td><td>Auto PWM – PFM mode based on load</td></tr> <tr><td>1</td><td>Forced PWM mode enabled</td></tr> </tbody> </table>	Code	Mode	0	Auto PWM – PFM mode based on load	1	Forced PWM mode enabled																																																																																																																		
Code	Mode																																																																																																																										
0	Auto PWM – PFM mode based on load																																																																																																																										
1	Forced PWM mode enabled																																																																																																																										
1:0	Reserved	00																																																																																																																									
MANUFACTURER_ID R REGISTER ADDRESS: 40																																																																																																																											
7:0	Manufacture_ID	10000011																																																																																																																									
DEVICE_ID R REGISTER ADDRESS: 41																																																																																																																											
7:0	Device_ID	00000111																																																																																																																									

FAN49103

APPLICATION GUIDELINES

Table 4. RECOMMENDED EXTERNAL COMPONENTS

Reference Designator	Description	Quantity	Part Number
L	1 μ H, Isat(max) = 4.2 A, 36 m Ω (max), 2016	1	Cyntec HTEH20161T-1R0MSR
C _{OUT}	47 μ F (x2), 6.3 V, X5R, 1608	2	Murata GRM188R60J476ME15
C _{IN}	22 μ F, 10 V, X5R, 1608	1	Murata GRM187R61A226ME15

Alternative External Components

It is recommended to use the external components in Table 4. Alternative components that are suitable for a design's specific requirements must also meet the IC's requirements for proper device operation.

De-rating factors should be taken into consideration to ensure selected components meet minimum requirements.

Output Capacitor (C_{OUT})

As shown in the recommended layout, C_{OUT} must connect to the VOUT pin with the lowest impedance trace possible. Additionally, C_{OUT} must connect to the GND pin with the lowest impedance possible.

Smaller-than-recommended value output capacitors may be used for applications with reduced load current requirements. When selecting capacitors for minimal solution size, it must be noted that the effective capacitance (C_{EFF}) of small, high-value, ceramic capacitors will decrease as bias voltage increases. The effects of Bias Voltage (DC Bias Characteristics), Tolerance, and

Temperature should be included when determining a component's effective capacitance.

The FAN49103 is guaranteed for stable operation with no less than the minimum effective output capacitance values shown in Table 5.

Table 5. REQUIRED MINIMUM EFFECTIVE OUTPUT CAPACITANCE VERSUS MAXIMUM LOAD

Maximum Load Current	Inductor (μ H)	Required Minimum Effective Output Capacitance (μ F)
≤ 2000 mA	1.0	15
	0.47	9
≤ 1500 mA	1.0	12
≤ 1000 mA	1.0	9
≤ 600 mA	1.0	7
≤ 500 mA	1.0	6

Table 6. EFFECTIVE CAPACITANCE VERSUS PART NUMBER

PN	Size (mm) LW x H	Nominal Value (μ F)	Rating (V)	Tol. (%)	Bias (V)	Effective Capacitance (μ F) Due to Bias, Temperature and Tolerance
Murata GRM188R60J476ME15	1608 x 1.0	47	6.3	20	3.4	8.5
Murata GRM187R61A226ME15	1608 x 0.8	22	10	20	3.4	6.3
					5	4.2
Murata GRM188R61A106KE69	1608 x 1.0	10	10	10	3.4	3.2
					5	2.3

Input Capacitor (C_{IN})

As shown in the recommended layout, C_{IN} must connect to the PVIN pin with the lowest impedance trace possible. Additionally, C_{IN} must connect to the GND pin with the lowest impedance possible.

The FAN49103 is guaranteed for stable operation with a minimum effective capacitance of 2 μ F. It is recommended to use a high quality input capacitor rated at 10 μ F nominal or greater. Additional capacitance is required when the FAN49103's power source is not located close to the device.

Inductor (L)

As shown in the recommended layout, the inductor (L) must connect to the SW1 and SW2 pins with the lowest impedance trace possible.

The recommended nominal inductance value is 1.0 μ H. A value of 0.47 μ H can be used, but higher peak currents should be expected.

The FAN49103 employs peak current limiting, and the peak inductor current can reach I_{P_LIM} before limiting, therefore current saturation should be considered when choosing an inductor.

Table 7. ALTERNATE INDUCTOR OPTIONS

Description	Part Number
1 μ H, Isat(max) = 5.0 A, 25 m Ω (max), 2520	Cyntec HTEH20161T-1R0MSR
1 μ H, Isat(max) = 5.3 A, 23 m Ω (max), 2520	Semco CIGT252010TM1R0ML

FAN49103

LAYOUT RECOMMENDATIONS

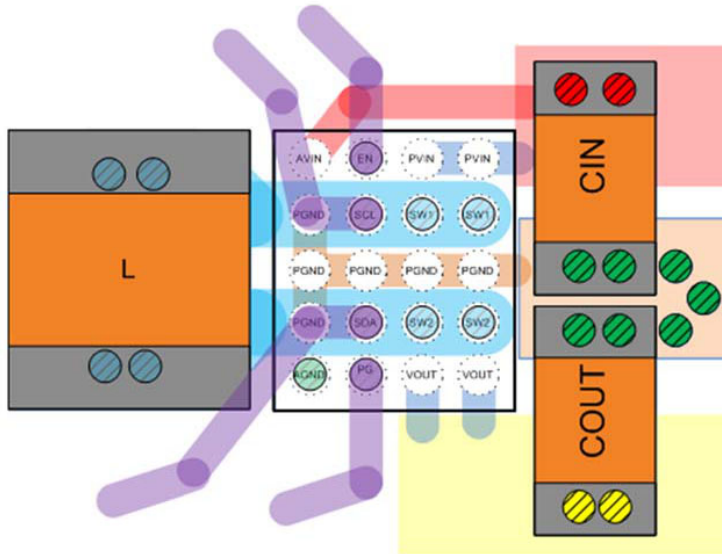

Figure 38. Component Placement and Routing for FAN49103

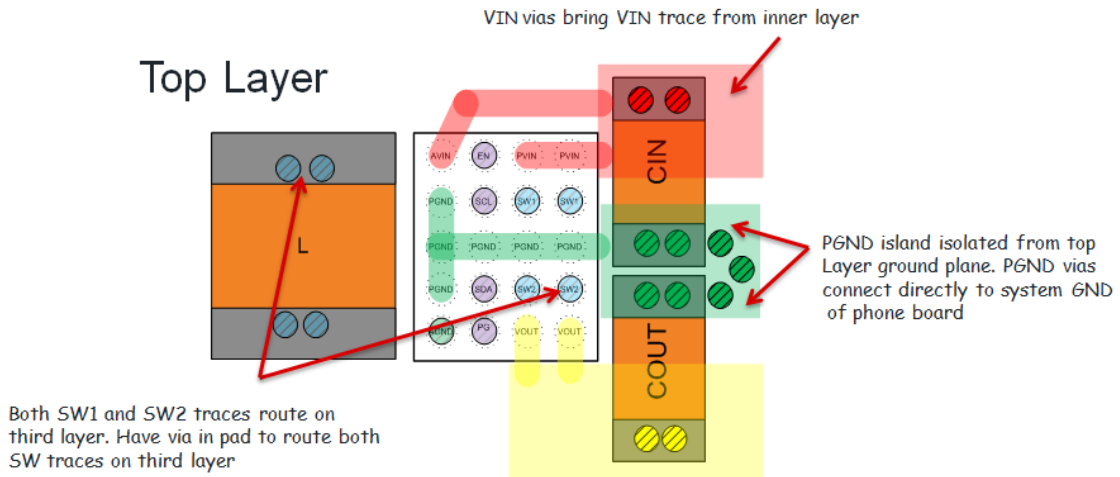

Figure 39. Top Layer Routing for FAN49103

FAN49103

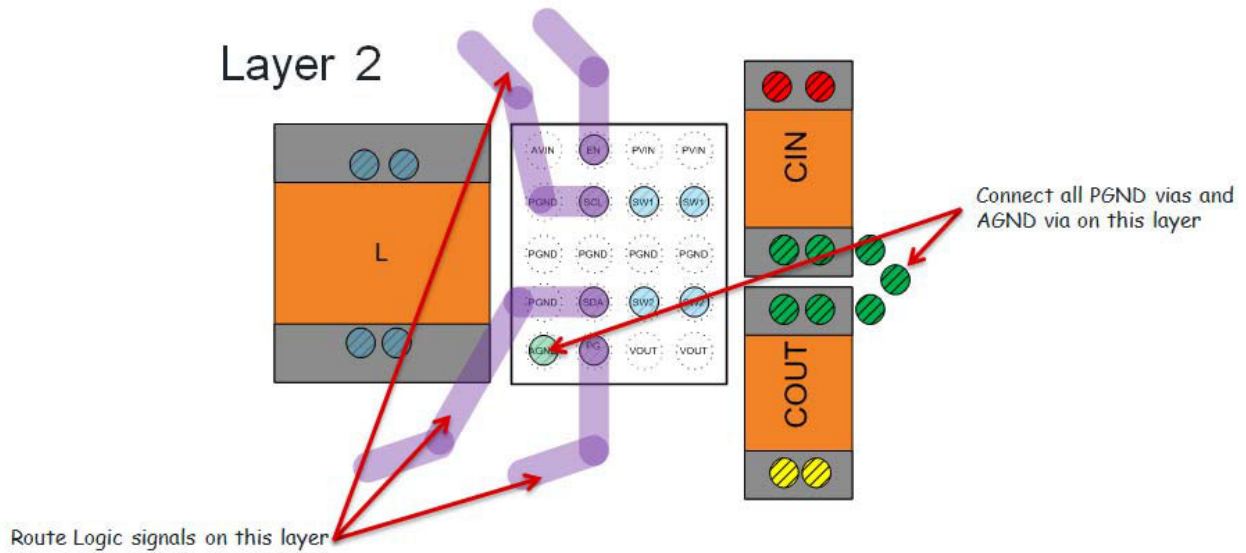

Figure 40. Layer 2 Routing for FAN49103

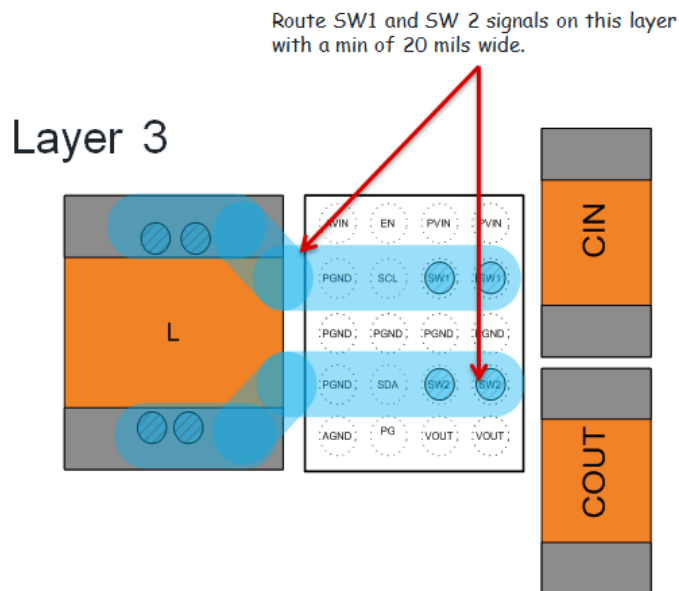

Figure 41. Layer 3 Routing for FAN49103

PHYSICAL DIMENSIONS

This table information applies to the Package drawing on the following page.

Product	D	E	X	Y
FAN49103AUC340X	2.015 ±0.030	1.615 ±0.030	0.2075	0.2075
FAN49103AUC330X	2.015 ±0.030	1.615 ±0.030	0.2075	0.2075
FAN49103AUC34AX	2.015 ±0.030	1.615 ±0.030	0.2075	0.2075

TinyPower is registered trademarks of Semiconductor Components Industries, LLC (SCILLC) or its subsidiaries in the United States and/or other countries. I²C **onsemi** is licensed by the Philips Corporation to carry the I2C bus protocol.

WLCSP20 2.015x1.615x0.586
CASE 567QK
ISSUE O

DATE 31 OCT 2016

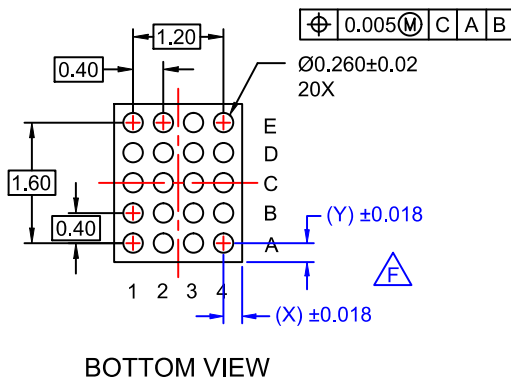
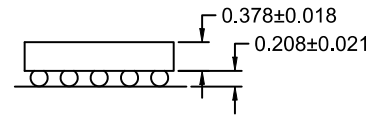
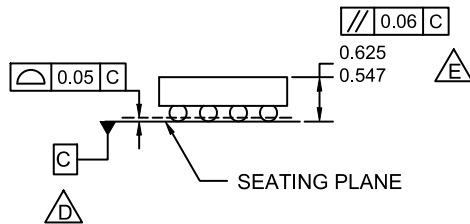
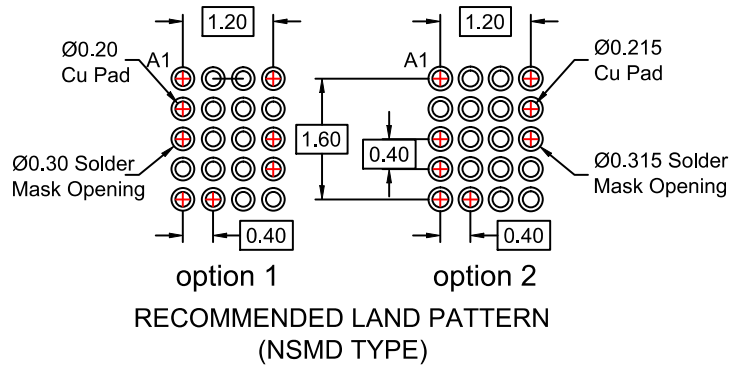
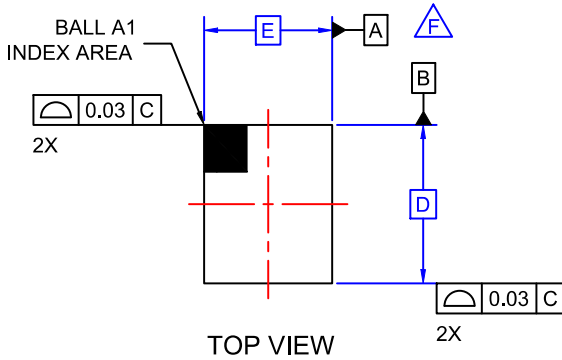

NOTES:

- A. NO JEDEC REGISTRATION APPLIES.
- B. DIMENSIONS ARE IN MILLIMETERS.
- C. DIMENSIONS AND TOLERANCE PER ASMEY14.5M, 2009.
- D. DATUM C IS DEFINED BY THE SPHERICAL CROWNS OF THE BALLS.
- E. PACKAGE NOMINAL HEIGHT IS 586 MICRONS ±39 MICRONS (547-625 MICRONS).
- F. FOR DIMENSIONS D, E, X, AND Y SEE PRODUCT DATASHEET.

DOCUMENT NUMBER:	98AON13330G	Electronic versions are uncontrolled except when accessed directly from the Document Repository. Printed versions are uncontrolled except when stamped "CONTROLLED COPY" in red.
DESCRIPTION:	WLCSP20 2.015x1.615x0.586	PAGE 1 OF 1

onsemi and Onsemi are trademarks of Semiconductor Components Industries, LLC dba onsemi or its subsidiaries in the United States and/or other countries. onsemi reserves the right to make changes without further notice to any products herein. onsemi makes no warranty, representation or guarantee regarding the suitability of its products for any particular purpose, nor does onsemi assume any liability arising out of the application or use of any product or circuit, and specifically disclaims any and all liability, including without limitation special, consequential or incidental damages. onsemi does not convey any license under its patent rights nor the rights of others.

onsemi, **Onsemi**, and other names, marks, and brands are registered and/or common law trademarks of Semiconductor Components Industries, LLC dba "**onsemi**" or its affiliates and/or subsidiaries in the United States and/or other countries. **onsemi** owns the rights to a number of patents, trademarks, copyrights, trade secrets, and other intellectual property. A listing of **onsemi**'s product/patent coverage may be accessed at www.onsemi.com/site/pdf/Patent-Marking.pdf. **onsemi** reserves the right to make changes at any time to any products or information herein, without notice. The information herein is provided "as-is" and **onsemi** makes no warranty, representation or guarantee regarding the accuracy of the information, product features, availability, functionality, or suitability of its products for any particular purpose, nor does **onsemi** assume any liability arising out of the application or use of any product or circuit, and specifically disclaims any and all liability, including without limitation special, consequential or incidental damages. Buyer is responsible for its products and applications using **onsemi** products, including compliance with all laws, regulations and safety requirements or standards, regardless of any support or applications information provided by **onsemi**. "Typical" parameters which may be provided in **onsemi** data sheets and/or specifications can and do vary in different applications and actual performance may vary over time. All operating parameters, including "Typicals" must be validated for each customer application by customer's technical experts. **onsemi** does not convey any license under any of its intellectual property rights nor the rights of others. **onsemi** products are not designed, intended, or authorized for use as a critical component in life support systems or any FDA Class 3 medical devices or medical devices with a same or similar classification in a foreign jurisdiction or any devices intended for implantation in the human body. Should Buyer purchase or use **onsemi** products for any such unintended or unauthorized application, Buyer shall indemnify and hold **onsemi** and its officers, employees, subsidiaries, affiliates, and distributors harmless against all claims, costs, damages, and expenses, and reasonable attorney fees arising out of, directly or indirectly, any claim of personal injury or death associated with such unintended or unauthorized use, even if such claim alleges that **onsemi** was negligent regarding the design or manufacture of the part. **onsemi** is an Equal Opportunity/Affirmative Action Employer. This literature is subject to all applicable copyright laws and is not for resale in any manner.

ADDITIONAL INFORMATION

TECHNICAL PUBLICATIONS:

Technical Library: www.onsemi.com/design/resources/technical-documentation
onsemi Website: www.onsemi.com

ONLINE SUPPORT: www.onsemi.com/support

For additional information, please contact your local Sales Representative at www.onsemi.com/support/sales