

# Single-Channel High-Side Gate Drive IC

## FAN73611

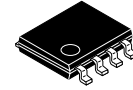

SOIC8  
 (8-SOP)  
 CASE 751EG

### Description

The FAN73611 is a monolithic high-side gate drive IC that can drive MOSFETs and IGBTs operating up to +600 V. onsemi's high-voltage process and commonmode noise canceling techniques provide stable operation of the high-side driver under high dv/dt noise circumstances. An advanced level-shift circuit offers high-side gate driver operation up to  $V_S = -9.8$  V (typical) for  $V_{BS} = 15$  V. The UVLO circuits prevents malfunction when  $V_{DD}$  or  $V_{BS}$  is lower than the specified threshold voltage. The output drivers typically source/sink 250 mA/500 mA; respectively, which is suitable for Plasma Display Panel (PDP) application, motor drive inverter, and switching mode power supply applications.

### Features

- Floating Channel of Bootstrap Operation to +600 V
- 250 mA / 500 mA Sourcing/Sinking Current Driving Capability
- Common-Mode dv/dt Noise-Cancelling Circuit
- 3.3 V and 5 V Input Logic Compatible
- Output In Phase with Input Signal
- Under-Voltage Lockout for  $V_{DD}$  and  $V_{BS}$
- 8-Lead Small Outline Package (SOP)
- This is a Pb-Free Device

### Applications

- Electronic Ballast
- Switching-Mode Power Supply (SMPS)

### Related Resources

- [AN-6076 – Design and Application Guide of Bootstrap Circuit for High-Voltage Gate-Drive IC](#)
- [AN-9052 – Design Guide for Selection of Bootstrap Components](#)
- [AN-8102 – Recommendations to Avoid Short Pulse Width Issues in HVIC Gate Driver Applications](#)

### MARKING DIAGRAM

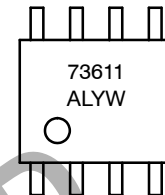

73611 = Device Code  
 A = Assembly Site  
 L = Wafer Lot Number  
 YW = Assembly Start Week

### ORDERING INFORMATION

See detailed ordering and shipping information on page 11 of this data sheet.

# FAN73611

## TYPICAL APPLICATION DIAGRAMS

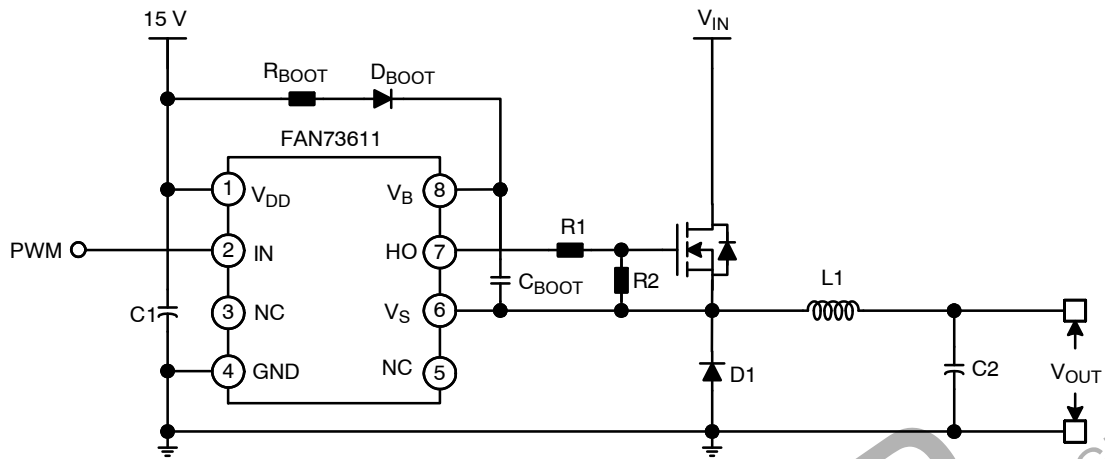

Figure 1. Step-Down (Buck) DC-DC Converter Application

## INTERNAL BLOCK DIAGRAM

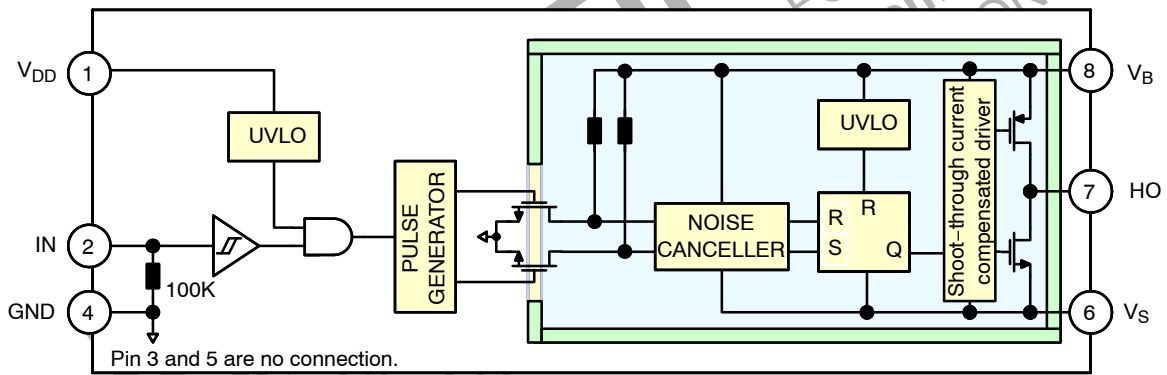

Figure 2. Functional Block Diagram

# FAN73611

## PIN CONFIGURATION

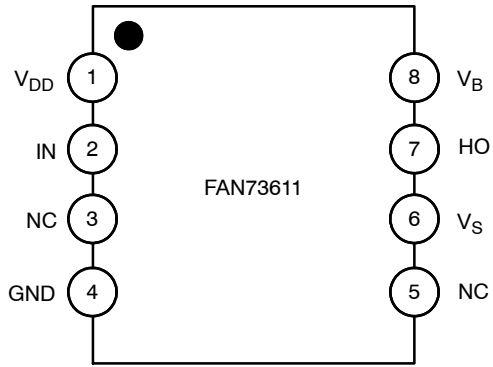

Figure 3. Pin Configuration (Top View)

### PIN DEFINITIONS

Pin No.	Name	Description
1	V <sub>DD</sub>	Supply Voltage
2	IN	Logic Input for High-Side Gate Driver Output
3	NC	No Connection
4	GND	Ground
5	NC	No Connection
6	V <sub>S</sub>	High-Voltage Floating Supply Return
7	HO	High-Side Driver Output
8	V <sub>B</sub>	High-Side Floating Supply

# FAN73611

## ABSOLUTE MAXIMUM RATINGS (T<sub>A</sub> = 25°C, unless otherwise specified.)

Symbol	Parameter	Min	Max	Unit
V <sub>S</sub>	High-Side Floating Offset Voltage	V <sub>B</sub> - 25	V <sub>B</sub> + 0.3	V
V <sub>B</sub>	High-Side Floating Supply Voltage	-0.3	625.0	V
V <sub>HO</sub>	High-Side Floating Output Voltage	V <sub>S</sub> - 0.3	V <sub>B</sub> + 0.3	V
V <sub>DD</sub>	Low-Side and Logic Supply Voltage	-0.3	25.0	V
V <sub>IN</sub>	Logic Input Voltage	-0.3	V <sub>DD</sub> + 0.3	V
dV <sub>S</sub> /dt	Allowable Offset Voltage Slew Rate	-	±50	V/ns
P <sub>D</sub>	Power Dissipation (Notes 1, 2, 3)	-	0.625	W
θ <sub>JA</sub>	Thermal Resistance	-	200	°C/W
T <sub>J</sub>	Junction Temperature	-55	+150	°C
T <sub>STG</sub>	Storage Temperature	-55	+150	°C

Stresses exceeding those listed in the Maximum Ratings table may damage the device. If any of these limits are exceeded, device functionality should not be assumed, damage may occur and reliability may be affected.

1. Mounted on 76.2 x 114.3 x 1.6 mm PCB (FR-4 glass epoxy material).

2. Refer to the following standards:

JESD51-2: Integral circuits thermal test method environmental conditions, natural convection, and

JESD51-3: Low effective thermal conductivity test board for leaded surface mount packages

3. Do not exceed power dissipation (P<sub>D</sub>) under any circumstances.

## RECOMMENDED OPERATING RATINGS

Symbol	Parameter	Min	Max	Unit
V <sub>B</sub>	High-Side Floating Supply Voltage	V <sub>S</sub> + 10	V <sub>S</sub> + 20	V
V <sub>S</sub>	High-Side Floating Supply Offset Voltage	6 - V <sub>DD</sub>	600	V
V <sub>HO</sub>	High-Side Output Voltage	V <sub>S</sub>	V <sub>B</sub>	V
V <sub>IN</sub>	Logic Input Voltage	GND	V <sub>DD</sub>	V
V <sub>DD</sub>	Supply Voltage	10	20	V
T <sub>A</sub>	Operating Ambient Temperature	-40	+125	°C

Functional operation above the stresses listed in the Recommended Operating Ranges is not implied. Extended exposure to stresses beyond the Recommended Operating Ranges limits may affect device reliability.

# FAN73611

**ELECTRICAL CHARACTERISTICS** ( $V_{BIAS}$  ( $V_{DD}$ ,  $V_{BS}$ ) = 15.0 V and  $T_A$  = 25°C unless otherwise specified. The  $V_{IN}$  and  $I_{IN}$  parameters are referenced to GND. The  $V_O$  and  $I_O$  parameters are relative to  $V_S$  and are applicable to the respective outputs HO.)

Symbol	Parameter	Test Condition	Min	Typ	Max	Unit
<b>POWER SUPPLY SECTION</b>						
$I_{QDD}$	Quiescent $V_{DD}$ Supply Current	$V_{IN} = 0$ V or 5 V, $C_{LOAD} = 1000$ pF	–	80	140	$\mu$ A
$I_{PDD}$	Operating $V_{DD}$ Supply Current	$C_{LOAD} = 1000$ pF, $f_{IN} = 20$ kHz, RMS value	–	80	160	$\mu$ A
$V_{DDUV+}$ $V_{BSUV+}$	$V_{DD}$ and $V_{BS}$ Supply Under-Voltage Positive Going Threshold Voltage	$V_{DD} =$ Sweep, $V_{BS} =$ Sweep	7.8	8.8	9.8	V
$V_{DDUV-}$ $V_{BSUV-}$	$V_{DD}$ and $V_{BS}$ Supply Under-Voltage Negative Going Threshold Voltage	$V_{DD} =$ Sweep, $V_{BS} =$ Sweep	7.3	8.3	9.3	V
$V_{DDHYS}$ $V_{BSHYS}$	$V_{DD}$ and $V_{BS}$ Supply Under-Voltage Lockout Hysteresis Voltage	$V_{DD} =$ Sweep, $V_{BS} =$ Sweep	–	0.5	–	V
$I_{LK}$	Offset Supply Leakage Current	$V_B = V_S = 600$ V	–	–	10	$\mu$ A
$I_{QBS}$	Quiescent $V_{BS}$ Supply Current	$V_{IN} = 0$ V or 5 V, $C_{LOAD} = 1000$ pF	–	60	100	$\mu$ A
$I_{PBS}$	Operating $V_{BS}$ Supply Current	$C_{LOAD} = 1000$ pF, $f_{IN} = 20$ kHz, RMS value	–	420	600	$\mu$ A

## INPUT LOGIC SECTION

$V_{IH}$	Logic “1” Input Voltage		2.5	–	–	V
$V_{IL}$	Logic “0” Input Voltage		–	–	0.8	V
$I_{IN+}$	Logic Input High Bias Current	$V_{IN} = 5$ V	–	50	75	$\mu$ A
$I_{IN-}$	Logic Input Low Bias Current	$V_{IN} = 0$ V	–	–	2	$\mu$ A
$R_{IN}$	Input Pull-Down Resistance		60	100	–	k $\Omega$

## GATE DRIVE OUTPUT SECTION

$V_{OH}$	High Level Output Voltage ( $V_{BIAS} - V_O$ )	No Load	–	–	0.1	V
$V_{OL}$	Low Level Output Voltage	No Load	–	–	0.1	V
$I_{O+}$	Output High, Short-Circuit Pulsed Current	$V_{HO} = 0$ V, $V_{IN} = 5$ V, $PW \leq 10$ $\mu$ s	200	250	–	mA
$I_{O-}$	Output Low, Short-Circuit Pulsed Current	$V_{HO} = 15$ V, $V_{IN} = 0$ V, $PW \leq 10$ $\mu$ s	400	500	–	mA
$V_S$	Allowable Negative $V_S$ Pin Voltage for IN Signal Propagation to HO	$V_{BS} = 15$ V	–	–9.8	–7.0	V

Product parametric performance is indicated in the Electrical Characteristics for the listed test conditions, unless otherwise noted. Product performance may not be indicated by the Electrical Characteristics if operated under different conditions.

## DYNAMIC ELECTRICAL CHARACTERISTICS

 ( $V_{DD} = V_{BS} = 15$  V,  $C_{LOAD} = 1000$  pF, and  $T_A = 25^\circ$ C, unless otherwise specified.)

Symbol	Parameter	Test Condition	Min	Typ	Max	Unit
$t_{on}$	Turn-on Propagation Delay Time	$V_S = 0$ V	70	120	170	ns
$t_{off}$	Turn-off Propagation Delay Time	$V_S = 0$ V	70	120	170	ns
$t_r$	Turn-on Rise Time		–	70	140	ns
$t_f$	Turn-off Fall Time		–	30	60	ns

Product parametric performance is indicated in the Electrical Characteristics for the listed test conditions, unless otherwise noted. Product performance may not be indicated by the Electrical Characteristics if operated under different conditions.

TYPICAL CHARACTERISTICS

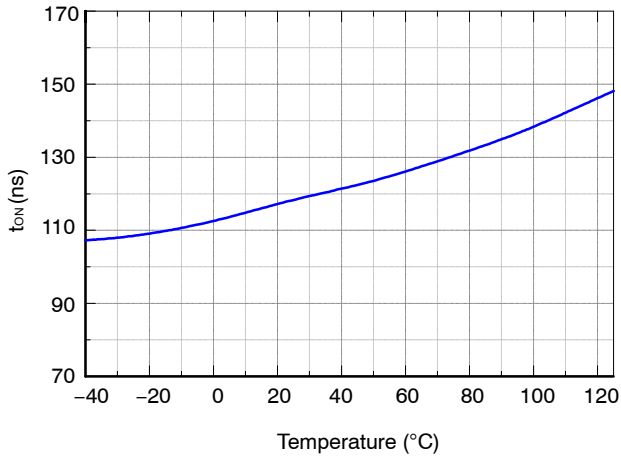

Figure 4. Turn-On Propagation Delay vs. Supply Voltage

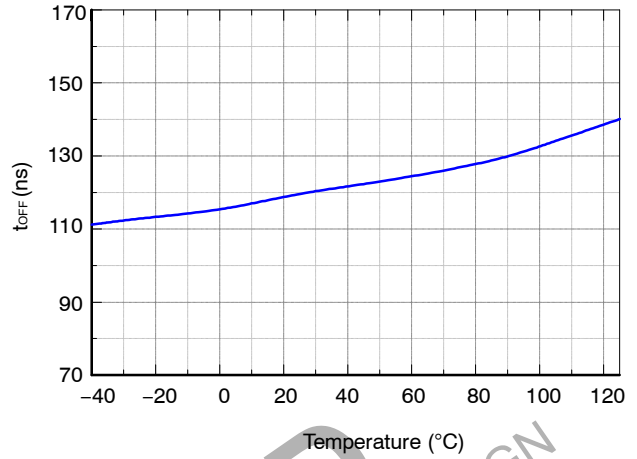

Figure 5. Turn-Off Propagation Delay vs. Temperature

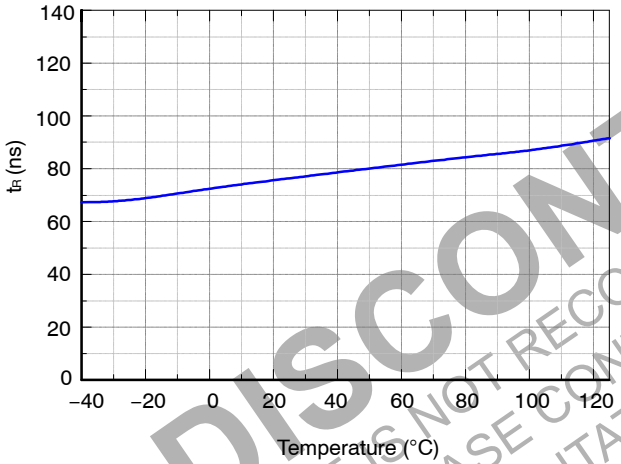

Figure 6. Turn-On Rise Time vs. Temperature

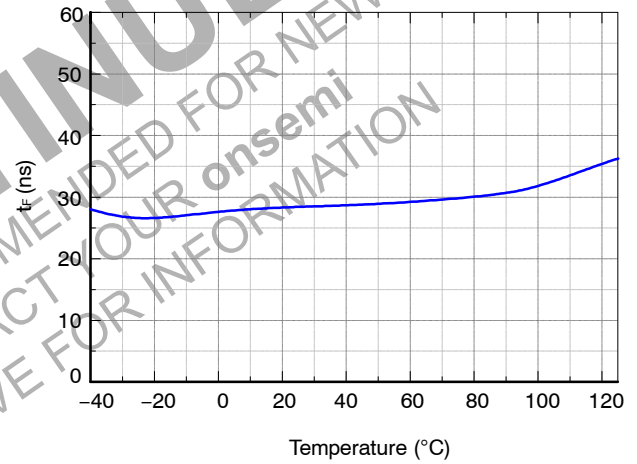

Figure 7. Turn-Off Fall Time vs. Temperature

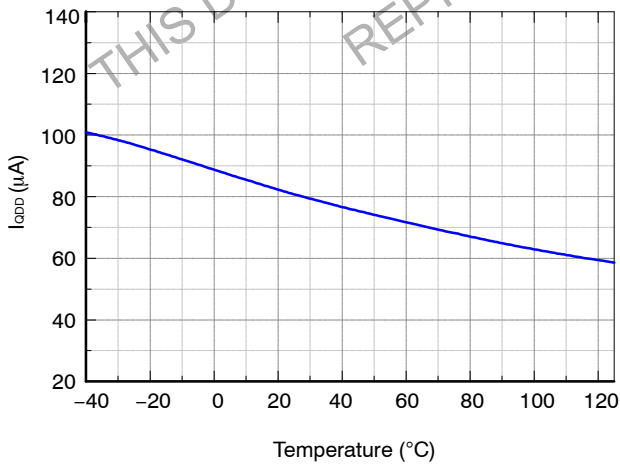

Figure 8. Quiescent V<sub>DD</sub> Supply Current vs. Temperature

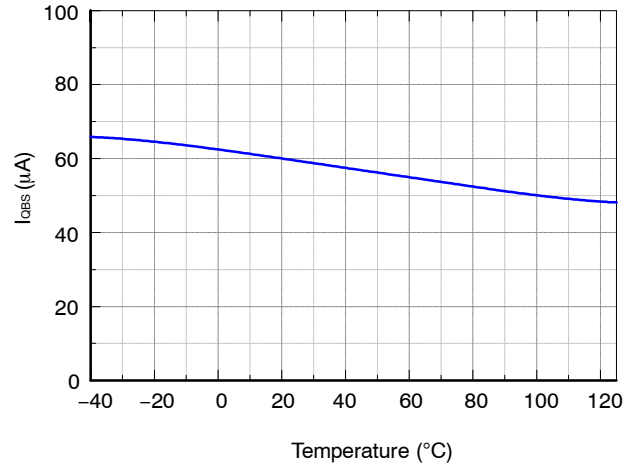

Figure 9. Quiescent V<sub>BS</sub> Supply Current vs. Temperature

TYPICAL CHARACTERISTICS (Continued)

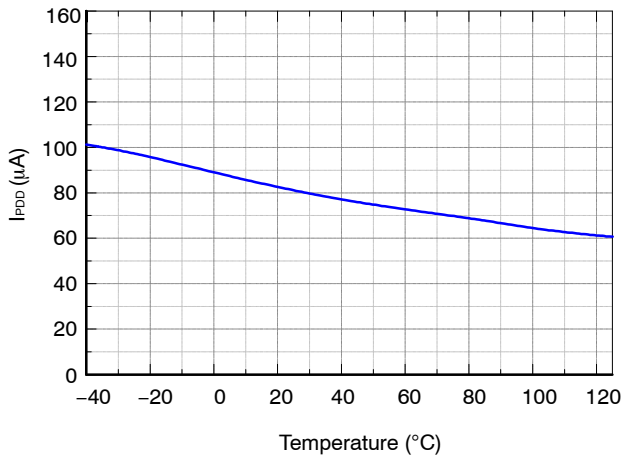

Figure 10. Operating  $V_{DD}$  Supply Current vs. Temperature

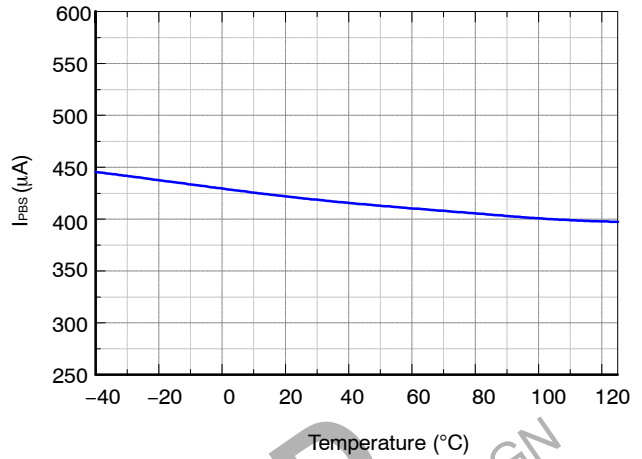

Figure 11. Operating  $V_{BS}$  Supply Current vs. Temperature

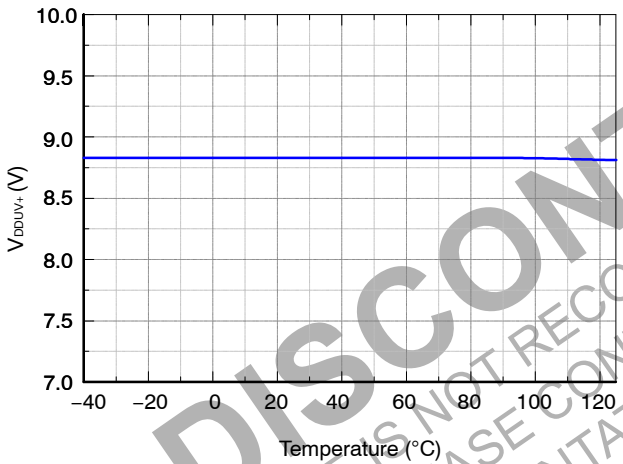

Figure 12.  $V_{DD}$  UVLO+ vs. Temperature

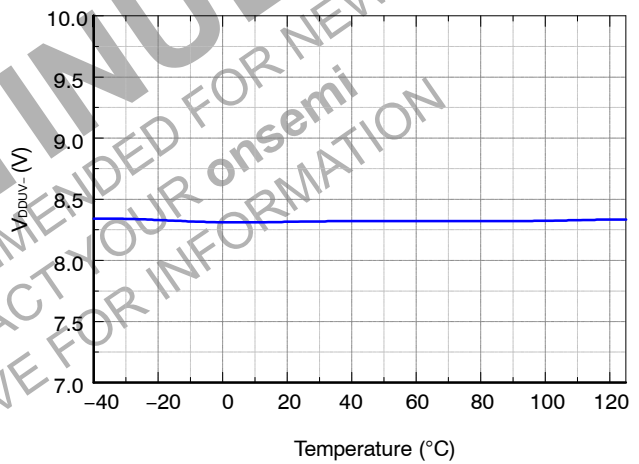

Figure 13.  $V_{DD}$  UVLO- vs. Temperature

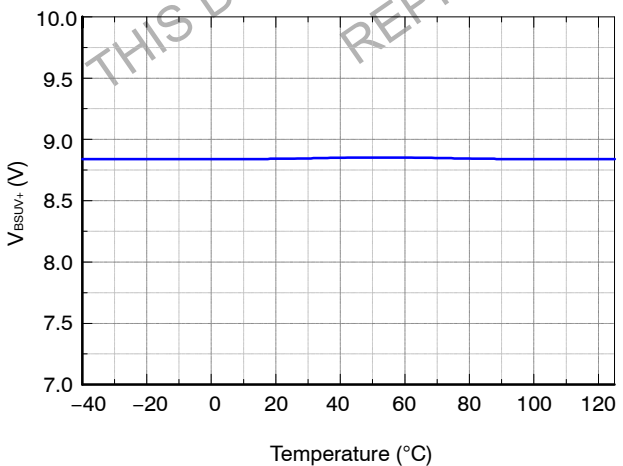

Figure 14.  $V_{BS}$  UVLO+ vs. Temperature

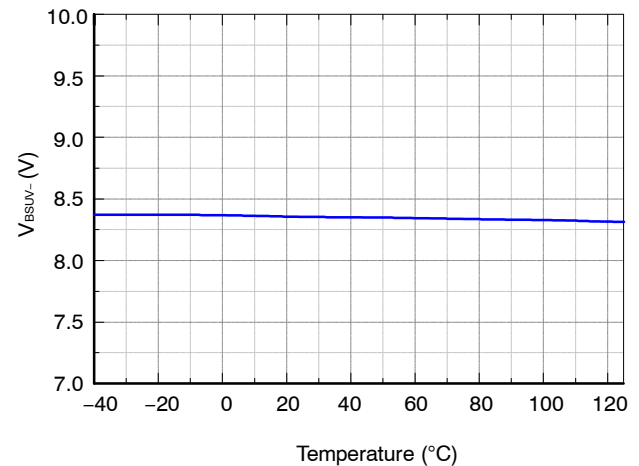

Figure 15.  $V_{BS}$  UVLO- vs. Temperature

TYPICAL CHARACTERISTICS (Continued)

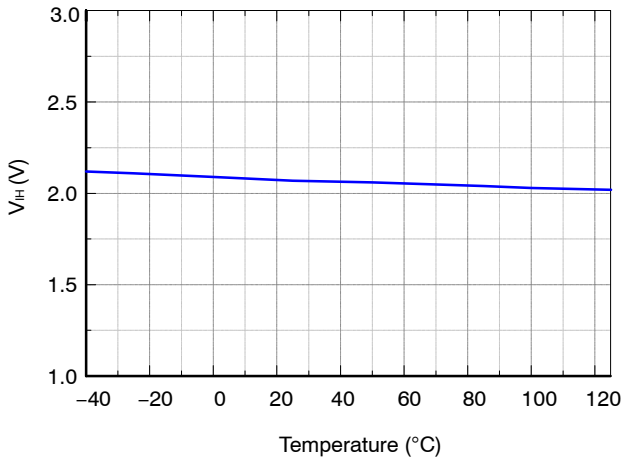

Figure 16. Logic HIGH Input Voltage vs. Temperature

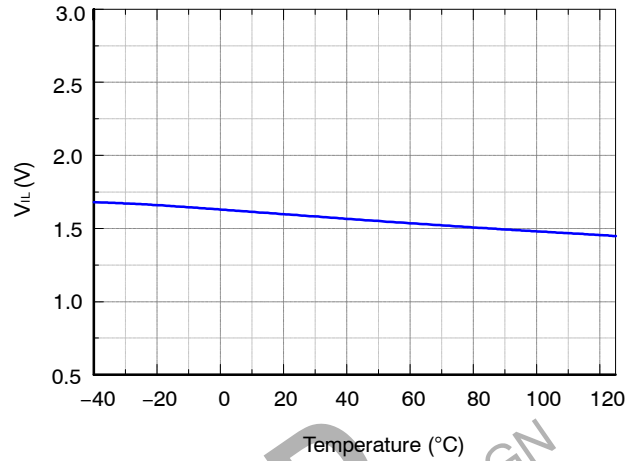

Figure 17. Logic LOW Input Voltage vs. Temperature

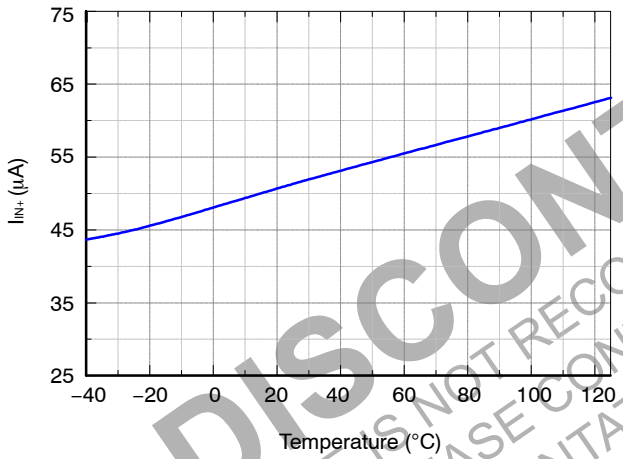

Figure 18. Logic HIGH Input Bias Current vs. Temperature

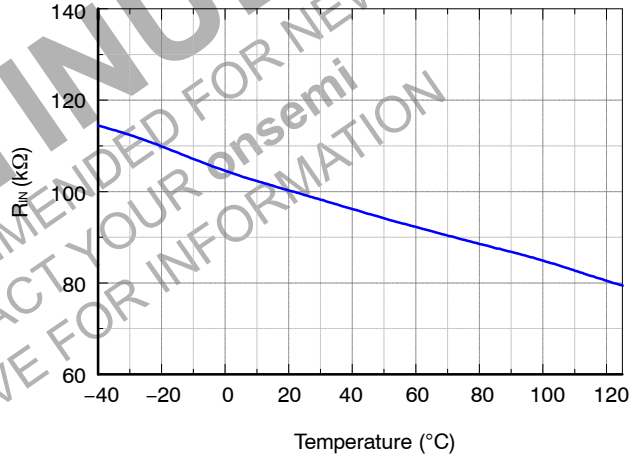

Figure 19. Input Pull-Down Resistance vs. Temperature

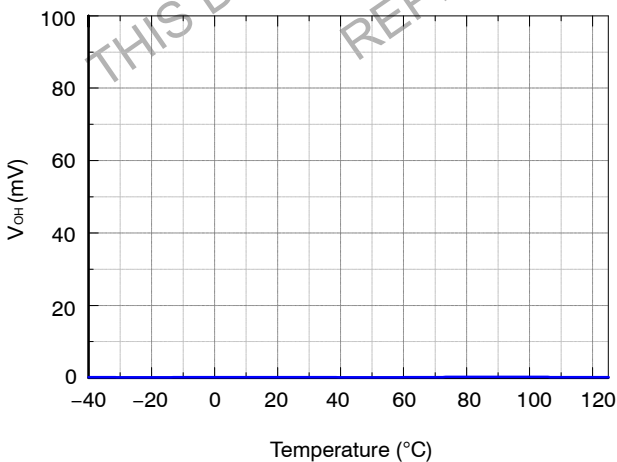

Figure 20. High-Level Output Voltage vs. Temperature

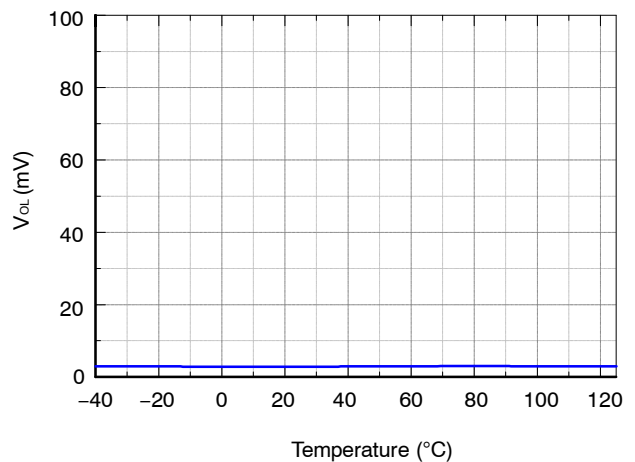

Figure 21. Low-Level Output Voltage vs. Temperature



TYPICAL CHARACTERISTICS (Continued)

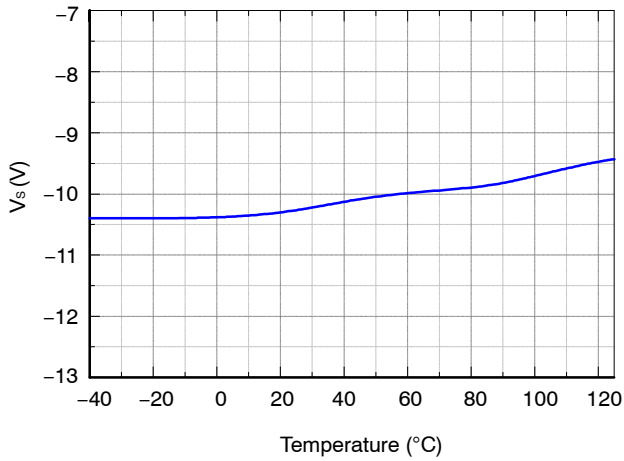

Figure 22. Allowable Negative  $V_S$  Voltage vs. Temperature

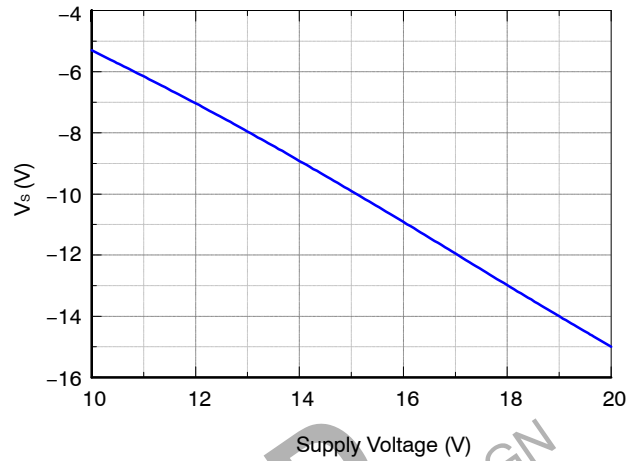

Figure 23. Allowable Negative  $V_S$  Voltage vs. Supply Voltage

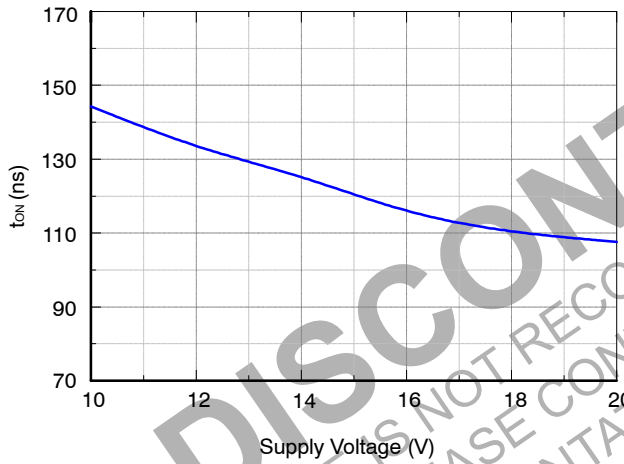

Figure 24. Turn-On Propagation Delay vs. Supply Voltage

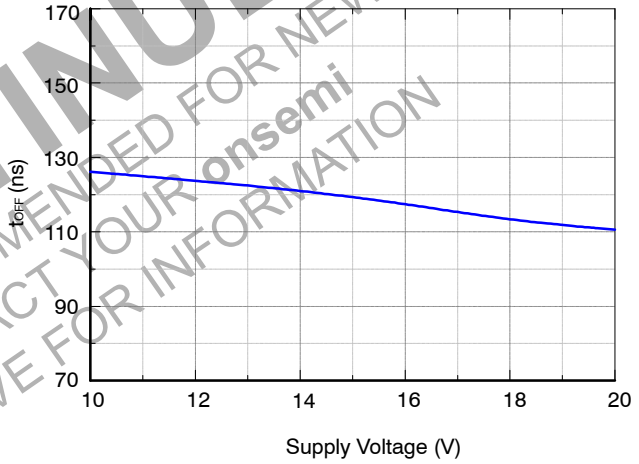

Figure 25. Turn-Off Propagation Delay vs. Supply Voltage

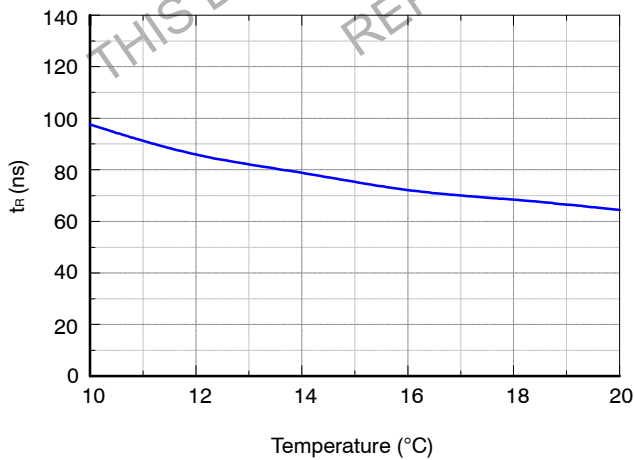

Figure 26. Turn-On Rise Time vs. Supply Voltage

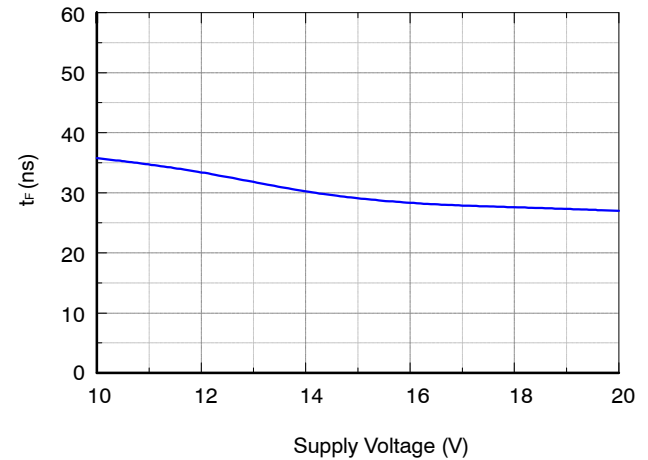

Figure 27. Turn-Off Fall Time vs. Supply Voltage

TYPICAL CHARACTERISTICS (Continued)

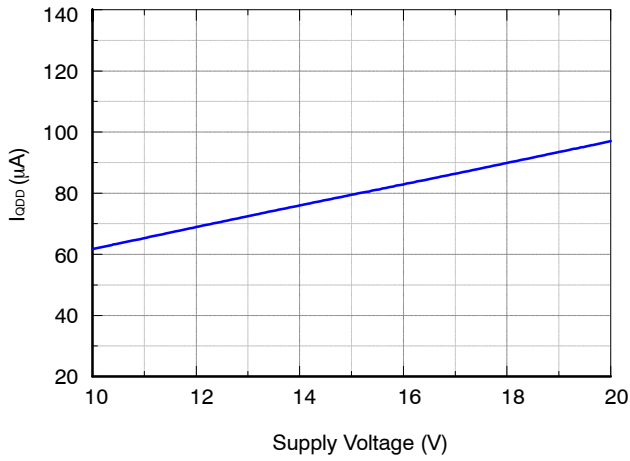

Figure 28. Quiescent  $V_{DD}$  Supply Current vs. Supply Voltage

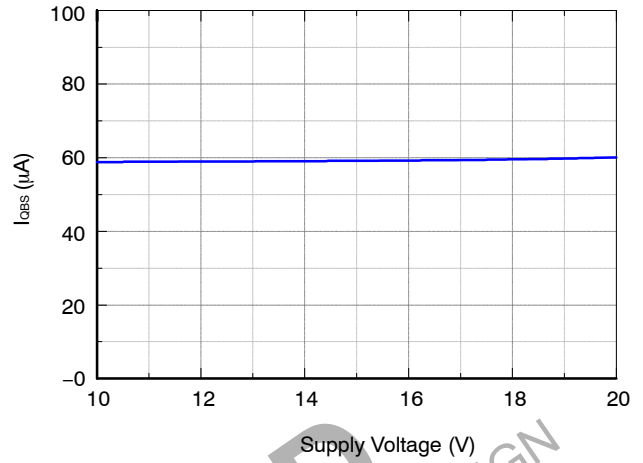

Figure 29. Quiescent  $V_{BS}$  Supply Current vs. Supply Voltage

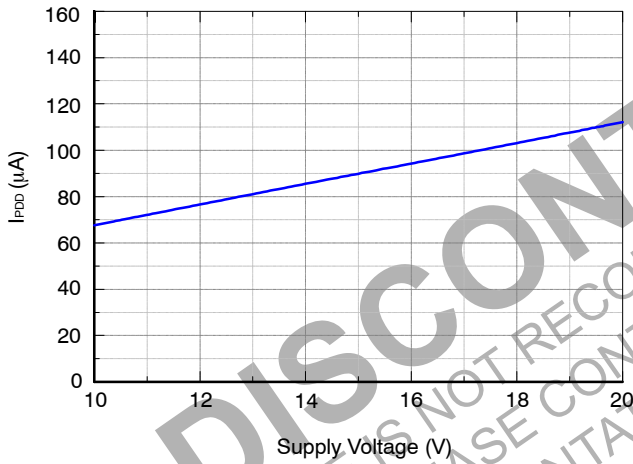

Figure 30. Operating  $V_{DD}$  Supply Current vs. Supply Voltage

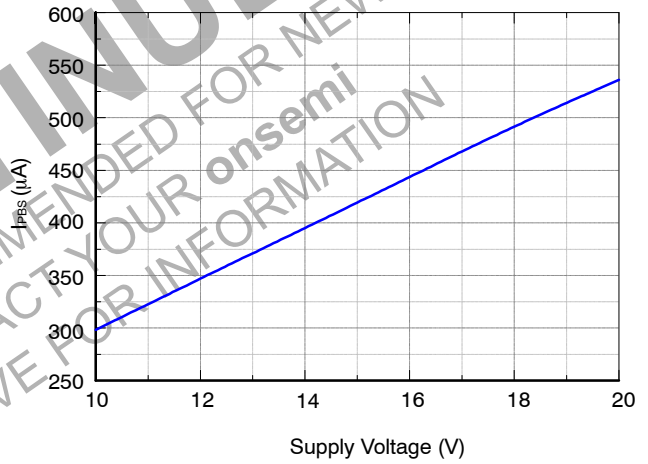

Figure 31. Operating  $V_{BS}$  Supply Current vs. Supply Voltage

# FAN73611

## SWITCHING TIME DEFINITIONS

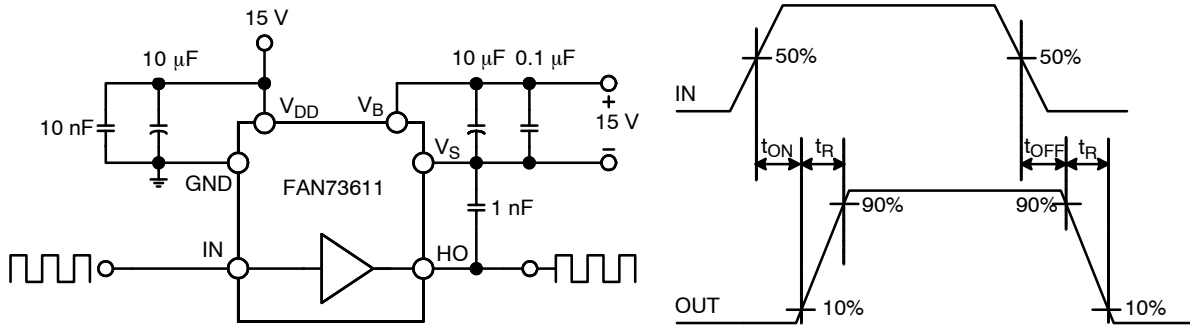

Figure 32. Switching Time Test Circuit and Waveforms Definitions

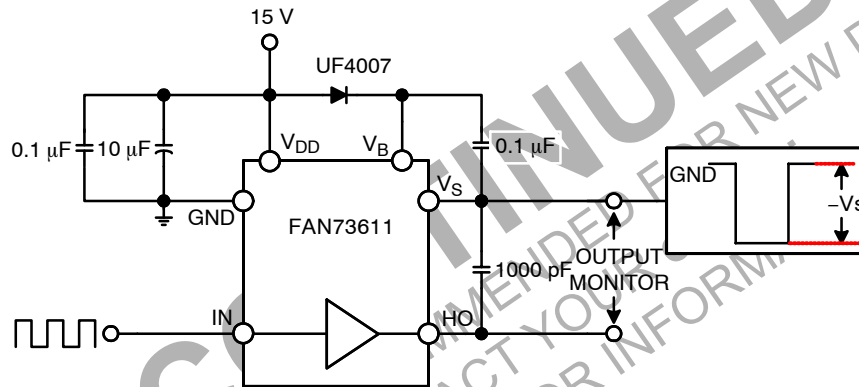

Figure 33. Floating Supply Voltage Transient Test

### ORDERING INFORMATION

Device	Package	Operating Temperature	Description	Shipping†
FAN73611MX (Note 4)	SOIC8 (8-SOP) (Pb-Free)	-40°C~+125°C	Lightning Application	3000 / Tape & Reel

4. This device has passed wave soldering test by JESD22A-111.

†For information on tape and reel specifications, including part orientation and tape sizes, please refer to our Tape and Reel Packaging Specifications Brochure, BRD8011/D.

**MECHANICAL CASE OUTLINE**  
**PACKAGE DIMENSIONS**

ON Semiconductor®



**SOIC8**  
**CASE 751EG**  
**ISSUE O**

DATE 30 SEP 2016

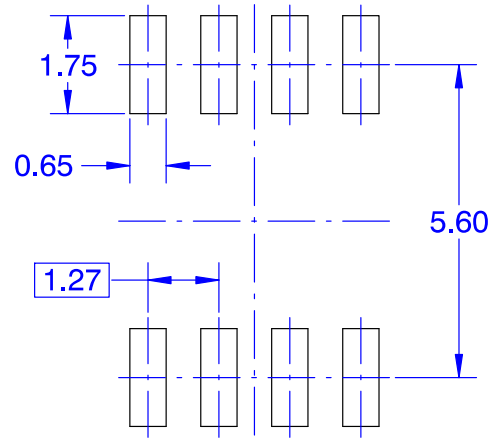

**NOTES: UNLESS OTHERWISE SPECIFIED**

- A. THIS PACKAGE CONFORMS TO JEDEC MS-012 VARIATION A EXCEPT WHERE NOTED.
- B. ALL DIMENSIONS ARE IN MILLIMETERS
- C. OUT OF JEDEC STANDARD VALUE
- D. DIMENSIONS ARE EXCLUSIVE OF BURRS, MOLD FLASH AND TIE BAR EXTRUSIONS.
- E. LAND PATTERN AS PER IPC SOIC127P600X175-8M

<b>DOCUMENT NUMBER:</b>	<b>98AON13741G</b>	Electronic versions are uncontrolled except when accessed directly from the Document Repository. Printed versions are uncontrolled except when stamped "CONTROLLED COPY" in red.
<b>DESCRIPTION:</b>	<b>SOIC8</b>	<b>PAGE 1 OF 1</b>

ON Semiconductor and are trademarks of Semiconductor Components Industries, LLC dba ON Semiconductor or its subsidiaries in the United States and/or other countries. ON Semiconductor reserves the right to make changes without further notice to any products herein. ON Semiconductor makes no warranty, representation or guarantee regarding the suitability of its products for any particular purpose, nor does ON Semiconductor assume any liability arising out of the application or use of any product or circuit, and specifically disclaims any and all liability, including without limitation special, consequential or incidental damages. ON Semiconductor does not convey any license under its patent rights nor the rights of others.

**onsemi**, **Onsemi**, and other names, marks, and brands are registered and/or common law trademarks of Semiconductor Components Industries, LLC dba "**onsemi**" or its affiliates and/or subsidiaries in the United States and/or other countries. **onsemi** owns the rights to a number of patents, trademarks, copyrights, trade secrets, and other intellectual property. A listing of **onsemi**'s product/patent coverage may be accessed at [www.onsemi.com/site/pdf/Patent-Marking.pdf](http://www.onsemi.com/site/pdf/Patent-Marking.pdf). **onsemi** reserves the right to make changes at any time to any products or information herein, without notice. The information herein is provided "as-is" and **onsemi** makes no warranty, representation or guarantee regarding the accuracy of the information, product features, availability, functionality, or suitability of its products for any particular purpose, nor does **onsemi** assume any liability arising out of the application or use of any product or circuit, and specifically disclaims any and all liability, including without limitation special, consequential or incidental damages. Buyer is responsible for its products and applications using **onsemi** products, including compliance with all laws, regulations and safety requirements or standards, regardless of any support or applications information provided by **onsemi**. "Typical" parameters which may be provided in **onsemi** data sheets and/or specifications can and do vary in different applications and actual performance may vary over time. All operating parameters, including "Typicals" must be validated for each customer application by customer's technical experts. **onsemi** does not convey any license under any of its intellectual property rights nor the rights of others. **onsemi** products are not designed, intended, or authorized for use as a critical component in life support systems or any FDA Class 3 medical devices or medical devices with a same or similar classification in a foreign jurisdiction or any devices intended for implantation in the human body. Should Buyer purchase or use **onsemi** products for any such unintended or unauthorized application, Buyer shall indemnify and hold **onsemi** and its officers, employees, subsidiaries, affiliates, and distributors harmless against all claims, costs, damages, and expenses, and reasonable attorney fees arising out of, directly or indirectly, any claim of personal injury or death associated with such unintended or unauthorized use, even if such claim alleges that **onsemi** was negligent regarding the design or manufacture of the part. **onsemi** is an Equal Opportunity/Affirmative Action Employer. This literature is subject to all applicable copyright laws and is not for resale in any manner.

## ADDITIONAL INFORMATION

### TECHNICAL PUBLICATIONS:

Technical Library: [www.onsemi.com/design/resources/technical-documentation](http://www.onsemi.com/design/resources/technical-documentation)  
onsemi Website: [www.onsemi.com](http://www.onsemi.com)

### ONLINE SUPPORT: [www.onsemi.com/support](http://www.onsemi.com/support)

For additional information, please contact your local Sales Representative at [www.onsemi.com/support/sales](http://www.onsemi.com/support/sales)