

MOSFET – N-Channel, SUPERFET® II

600 V, 20.2 A, 199 mΩ

FCP190N60, FCPF190N60

Description

SUPERFET II MOSFET is onsemi’s brand-new high voltage super-junction (SJ) MOSFET family that is utilizing charge balance technology for outstanding low on-resistance and lower gate charge performance. This technology is tailored to minimize conduction loss, provide superior switching performance, dv/dt rate and higher avalanche energy. Consequently, SUPERFET II MOSFET is very suitable for the switching power applications such as PFC, server/telecom power, FPD TV power, ATX power and industrial power applications.

Features

- 650 V @ $T_J = 150^\circ\text{C}$
- Typ. $R_{DS(on)} = 170\text{ m}\Omega$
- Ultra Low Gate Charge (Typ. $Q_g = 57\text{ nC}$)
- Low Effective Output Capacitance (Typ. $C_{oss(eff.)} = 160\text{ pF}$)
- 100% Avalanche Tested
- RoHS Compliant

Applications

- LCD, LED, PDP TV Lighting
- Solar Inverter
- AC-DC Power Supply

V_{DS}	$R_{DS(ON)}\text{ MAX}$	$I_D\text{ MAX}$
600 V	199 mΩ @ 10 V	20.2 A*

*Drain current limited by maximum junction temperature.

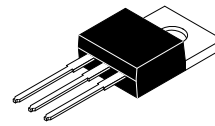
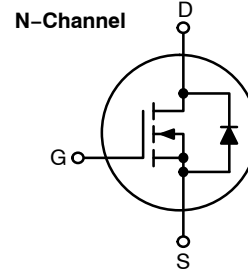

TO-220-3LD
 CASE 340AT

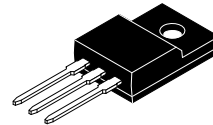

TO-220 Fullpack, 3-Lead
 / TO-220F-3SG
 CASE 221AT

MARKING DIAGRAM

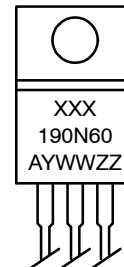

XXX190N60 = Device Code (XXX = FCP, FCPF)
 A = Assembly Location
 YWW = Date Code (Year & Week)
 ZZ = Assembly Lot

ORDERING INFORMATION

Device	Package	Shipping
FCP190N60	TO-220	800 Units / Tube
FCPF190N60	TO-220F	1000 Units / Tube

FCP190N60, FCPF190N60

MOSFET MAXIMUM RATINGS ($T_C = 25^\circ\text{C}$ unless otherwise noted)

Symbol	Parameter	FCP190N60	FCPF190N60	Unit	
V_{DSS}	Drain to Source Voltage	600		V	
V_{GSS}	Gate to Source Voltage	-DC	± 20		
		-AC ($f > 1$ Hz)	± 30		
I_D	Drain Current	- Continuous ($T_C = 25^\circ\text{C}$)	20.2	20.2*	A
		- Continuous ($T_C = 100^\circ\text{C}$)	12.7	12.7*	
I_{DM}	Drain Current	- Pulsed (Note 1)	60.6	60.6*	A
E_{AS}	Single Pulsed Avalanche Energy (Note 2)	400		mJ	
I_{AR}	Avalanche Current (Note 1)	4.0		A	
E_{AR}	Repetitive Avalanche Energy (Note 1)	2.1		mJ	
dv/dt	MOSFET dv/dt	100		V/ns	
	Peak Diode Recovery dv/dt (Note 3)	20			
P_D	Power Dissipation	($T_C = 25^\circ\text{C}$)	208	39	W
		-Derate above 25°C	1.67	0.31	W/ $^\circ\text{C}$
T_J, T_{STG}	Operating and Storage Temperature Range	-55 to +150		$^\circ\text{C}$	
T_L	Maximum Lead Temperature for Soldering, 1/8" from Case for 5 Seconds	300		$^\circ\text{C}$	

Stresses exceeding those listed in the Maximum Ratings table may damage the device. If any of these limits are exceeded, device functionality should not be assumed, damage may occur and reliability may be affected.

*Drain current limited by maximum junction temperature.

1. Repetitive rating: pulse-width limited by maximum junction temperature.
2. $I_{AS} = 4$ A, $V_{DD} = 50$ V, $R_G = 25$ Ω , starting $T_J = 25^\circ\text{C}$.
3. $I_{SD} \leq 10$ A, $di/dt \leq 200$ A/ μs , $V_{DD} \leq BV_{DSS}$, starting $T_J = 25^\circ\text{C}$.

THERMAL CHARACTERISTICS

Symbol	Parameter	FCP190N60	FCPF190N60	Unit
$R_{\theta JC}$	Thermal Resistance, Junction to Case, Max.	0.6	3.2	$^\circ\text{C}/\text{W}$
$R_{\theta JA}$	Thermal Resistance, Junction to Ambient, Max.	62.5	62.5	

FCP190N60, FCPF190N60

ELECTRICAL CHARACTERISTICS (T_C = 25°C unless otherwise noted)

Symbol	Parameter	Test Conditions	Min	Typ	Max	Unit
--------	-----------	-----------------	-----	-----	-----	------

OFF CHARACTERISTICS

BV _{DSS}	Drain to Source Breakdown Voltage	V _{GS} = 0 V, I _D = 10 mA, T _J = 25°C	600	–	–	V
		V _{GS} = 0 V, I _D = 10 mA, T _J = 150°C	650	–	–	
$\frac{\Delta BV_{DSS}}{\Delta T_J}$	Breakdown Voltage Temperature Coefficient	I _D = 10 mA, referenced to 25°C	–	0.67	–	V/°C
BV _{DS}	Drain to Source Avalanche Breakdown Voltage	V _{GS} = 0 V, I _D = 20 A	–	700	–	V
I _{DSS}	Zero Gate Voltage Drain Current	V _{DS} = 600 V, V _{GS} = 0 V	–	–	1	μA
		V _{DS} = 480 V, T _C = 125°C	–	1.3	–	
I _{GSS}	Gate to Body Leakage Current	V _{GS} = ±20 V, V _{DS} = 0 V	–	–	±100	nA

ON CHARACTERISTICS

V _{GS(th)}	Gate Threshold Voltage	V _{GS} = V _{DS} , I _D = 250 μA	2.5	–	3.5	V
R _{DS(on)}	Static Drain to Source On Resistance	V _{GS} = 10 V, I _D = 10 A	–	0.17	0.199	Ω
g _{FS}	Forward Transconductance	V _{DS} = 20 V, I _D = 10 A	–	21	–	S

DYNAMIC CHARACTERISTICS

C _{iss}	Input Capacitance	V _{DS} = 25 V, V _{GS} = 0 V, f = 1 MHz	–	2220	2950	pF
C _{oss}	Output Capacitance		–	1630	2165	
C _{rss}	Reverse Transfer Capacitance		–	85	128	
C _{oss}	Output Capacitance	V _{DS} = 380 V, V _{GS} = 0 V, f = 1 MHz	–	42	–	pF
C _{oss(eff.)}	Effective Output Capacitance	V _{DS} = 0 V to 480 V, V _{GS} = 0 V	–	160	–	pF
Q _{g(tot)}	Total Gate Charge at 10 V	V _{DS} = 380 V, I _D = 10 A, V _{GS} = 10 V (Note 4)	–	57	74	nC
Q _{gs}	Gate to Source Gate Charge		–	9	–	
Q _{gd}	Gate to Drain "Miller" Charge		–	21	–	
ESR	Equivalent Series Resistance	f = 1 MHz	–	1	–	Ω

SWITCHING CHARACTERISTICS

t _{d(on)}	Turn-On Delay Time	V _{DD} = 380 V, I _D = 10 A, V _{GS} = 10 V, R _G = 4.7 Ω (Note 4)	–	20	50	ns
t _r	Turn-On Rise Time		–	10	30	
t _{d(off)}	Turn-Off Delay Time		–	64	138	
t _f	Turn-Off Fall Time		–	5	20	

DRAIN-SOURCE DIODE CHARACTERISTICS

I _S	Maximum Continuous Drain to Source Diode Forward Current	–	–	20.2	A	
I _{SM}	Maximum Pulsed Drain to Source Diode Forward Current	–	–	60.6	A	
V _{SD}	Drain to Source Diode Forward Voltage	V _{GS} = 0 V, I _{SD} = 10 A	–	–	1.2	V
t _{rr}	Reverse Recovery Time	V _{GS} = 0 V, I _{SD} = 10 A, dI _F /dt = 100 A/μs	–	320	–	ns
Q _{rr}	Reverse Recovery Charge		–	5.1	–	μC

Product parametric performance is indicated in the Electrical Characteristics for the listed test conditions, unless otherwise noted. Product performance may not be indicated by the Electrical Characteristics if operated under different conditions.

4. Essentially independent of operating temperature typical characteristics.

FCP190N60, FCPF190N60

TYPICAL PERFORMANCE CHARACTERISTICS

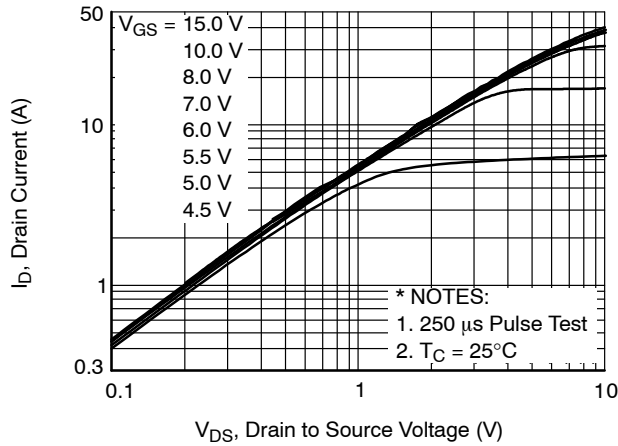

Figure 1. On-Region Characteristics

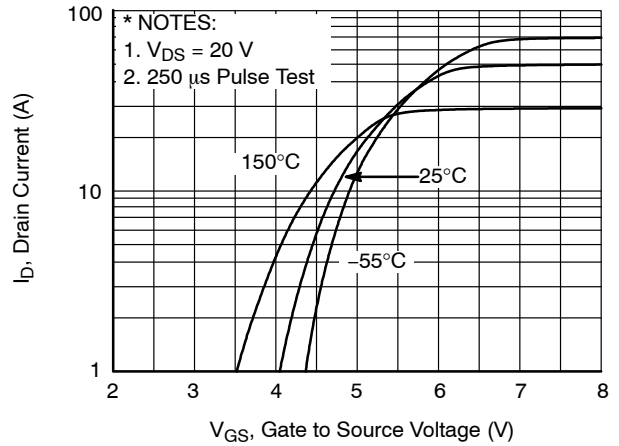

Figure 2. Transfer Characteristics

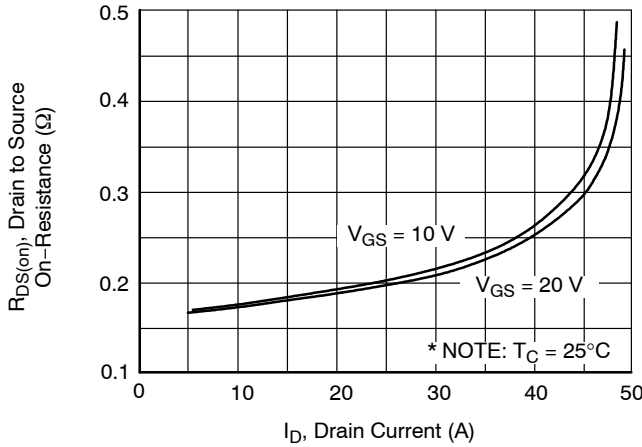

Figure 3. On-Resistance Variation vs. Drain Current and Gate Voltage

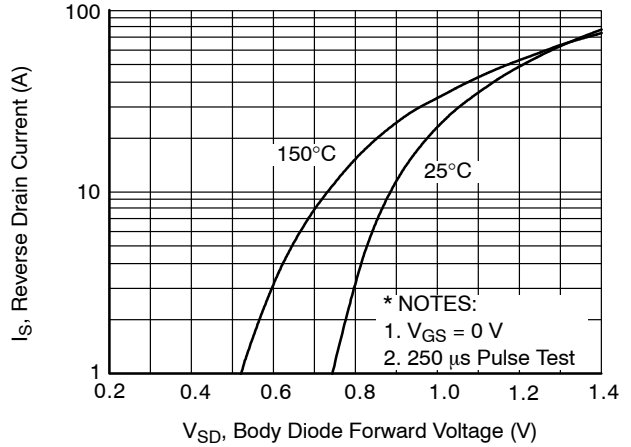

Figure 4. Body Diode Forward Voltage Variation vs. Source Current and Temperature

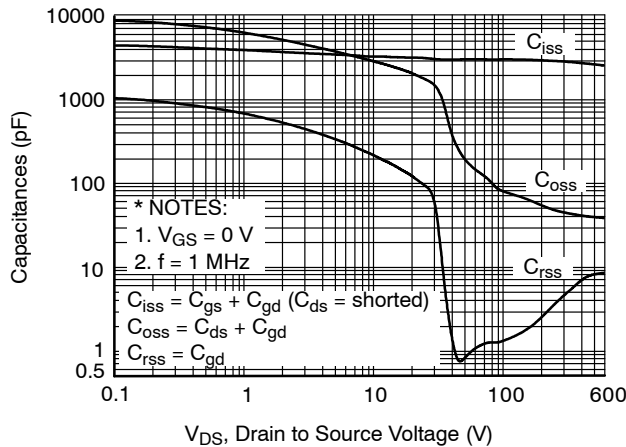

Figure 5. Capacitance Characteristics

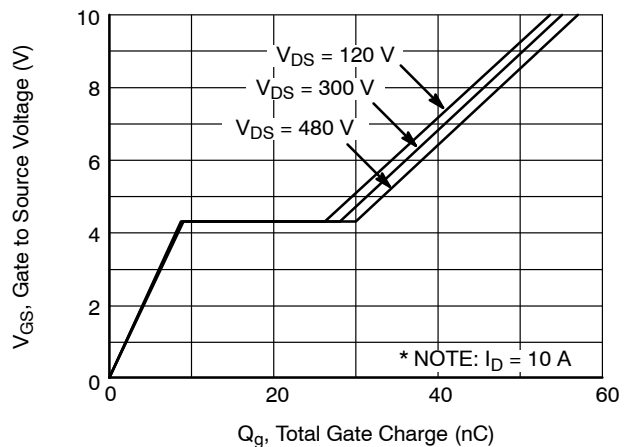

Figure 6. Gate Charge Characteristics

FCP190N60, FCPF190N60

TYPICAL PERFORMANCE CHARACTERISTICS (continued)

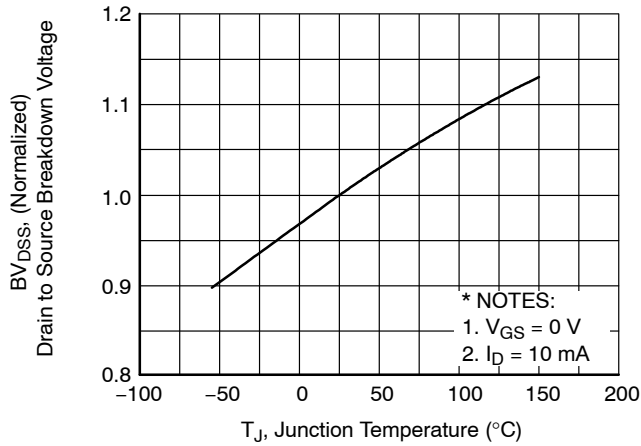

Figure 7. Breakdown Voltage Variation vs. Temperature

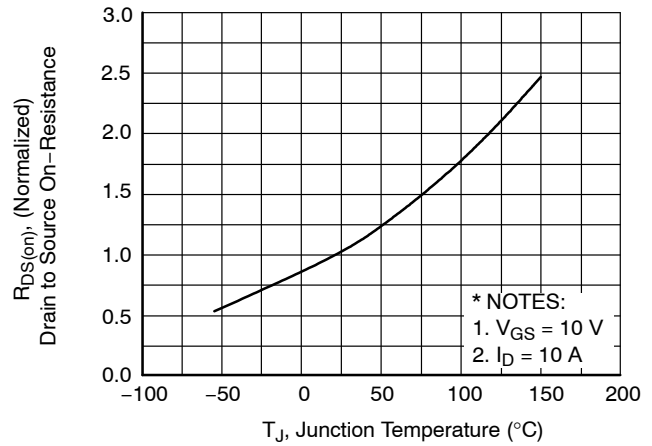

Figure 8. On-Resistance Variation vs. Temperature

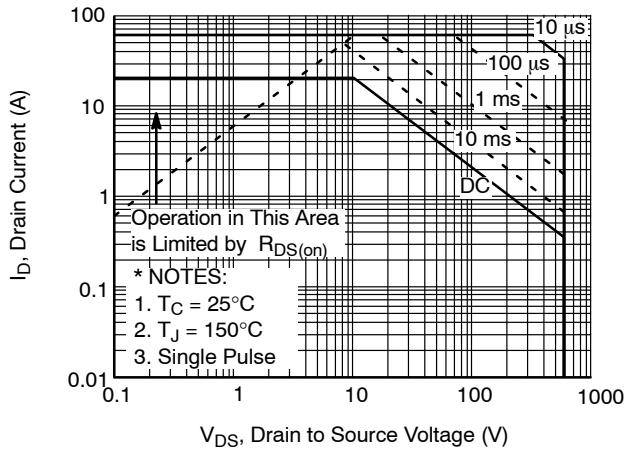

Figure 9. Maximum Safe Operating Area for FCP190N60

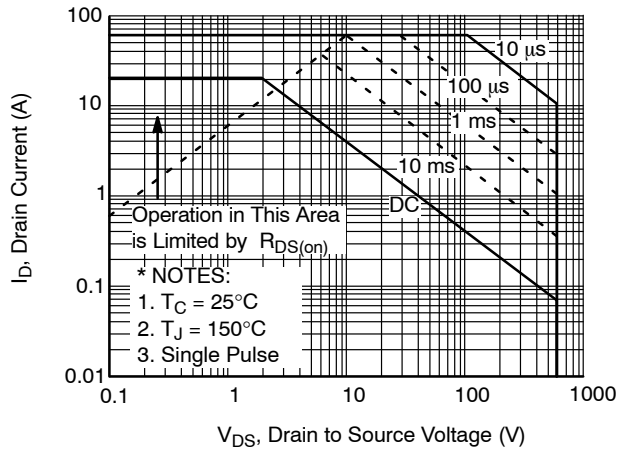

Figure 10. Maximum Safe Operating Area for FCPF190N60

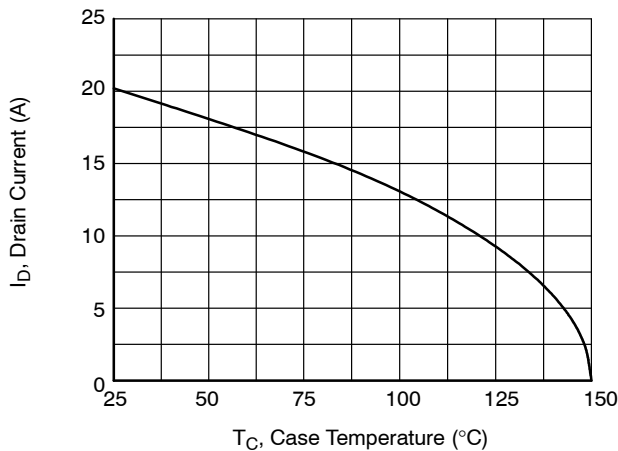

Figure 11. Maximum Drain Current vs. Case Temperature

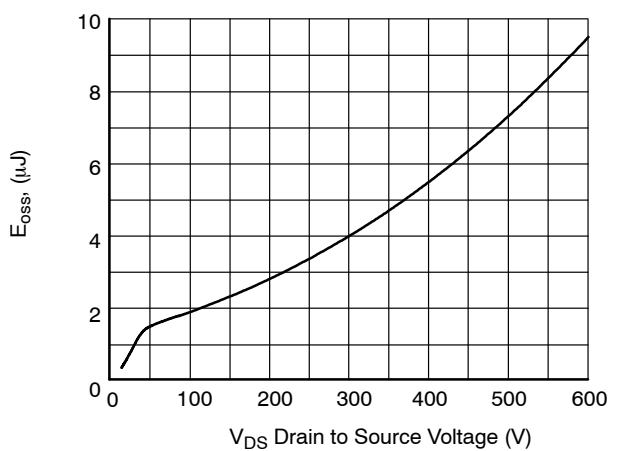

Figure 12. E_{OSS} vs. Drain to Source Voltage

FCP190N60, FCPF190N60

TYPICAL PERFORMANCE CHARACTERISTICS (continued)

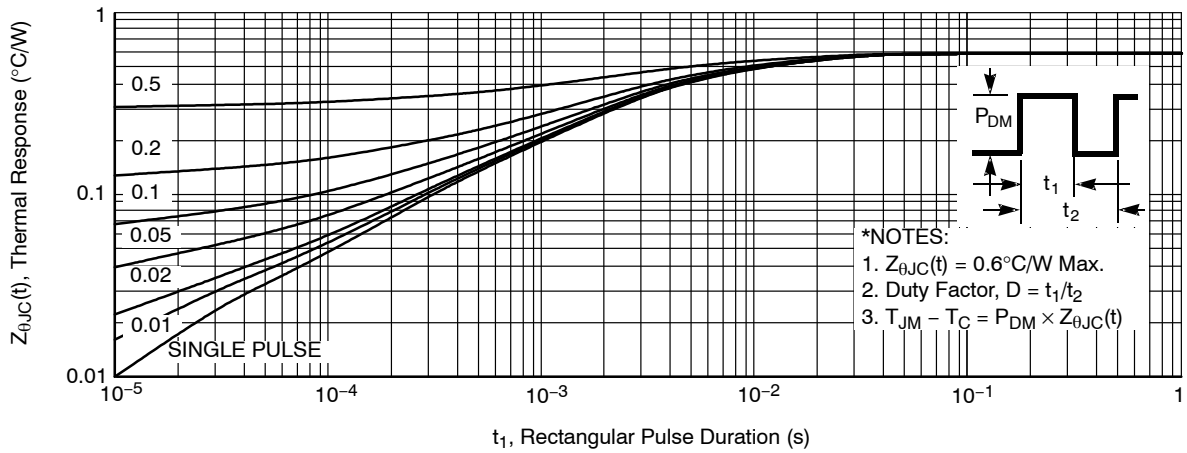

Figure 13. Transient Thermal Response Curve for FCP190N60

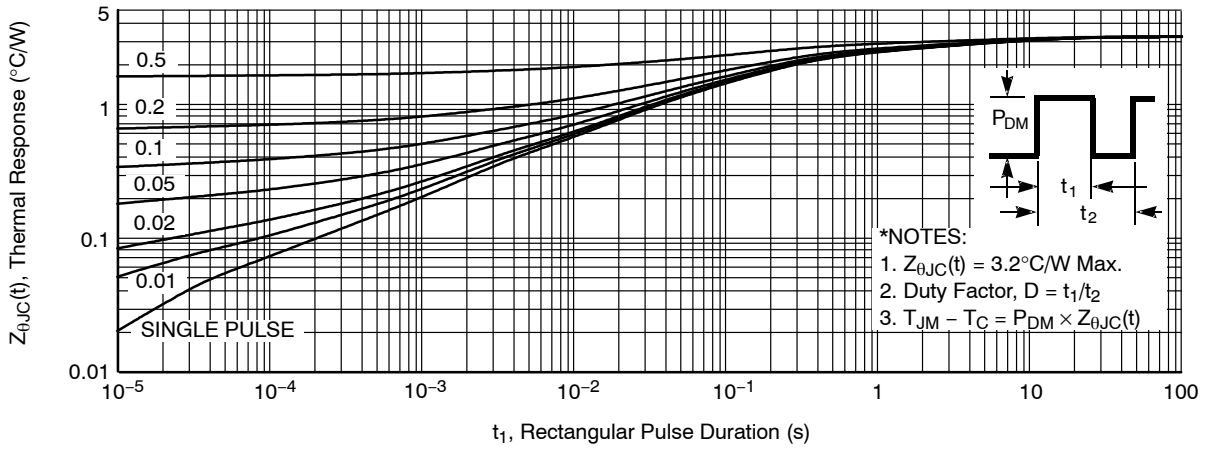

Figure 14. Transient Thermal Response Curve for FCPF190N60

FCP190N60, FCPF190N60

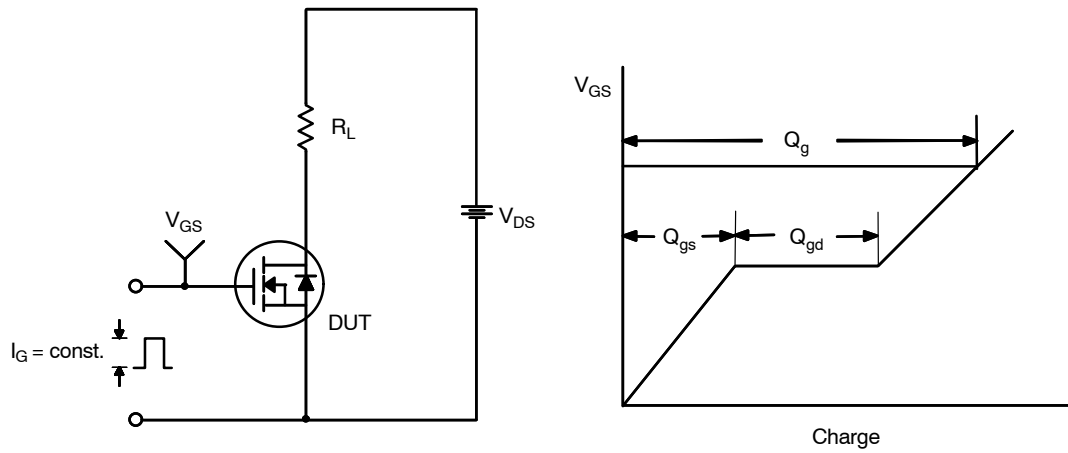

Figure 15. Gate Charge Test Circuit & Waveform

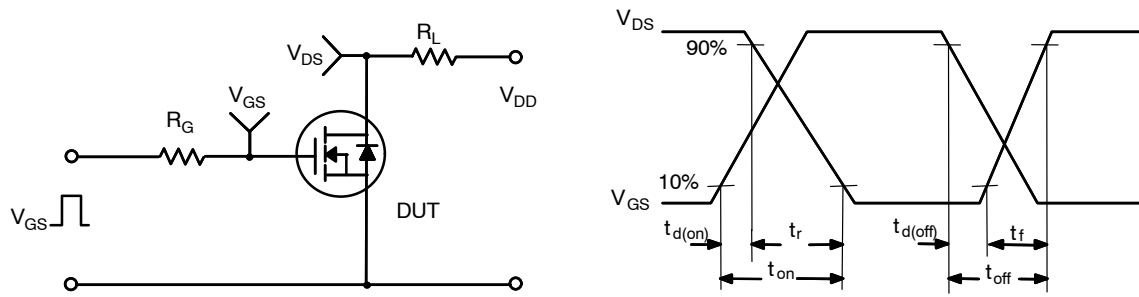

Figure 16. Resistive Switching Test Circuit & Waveforms

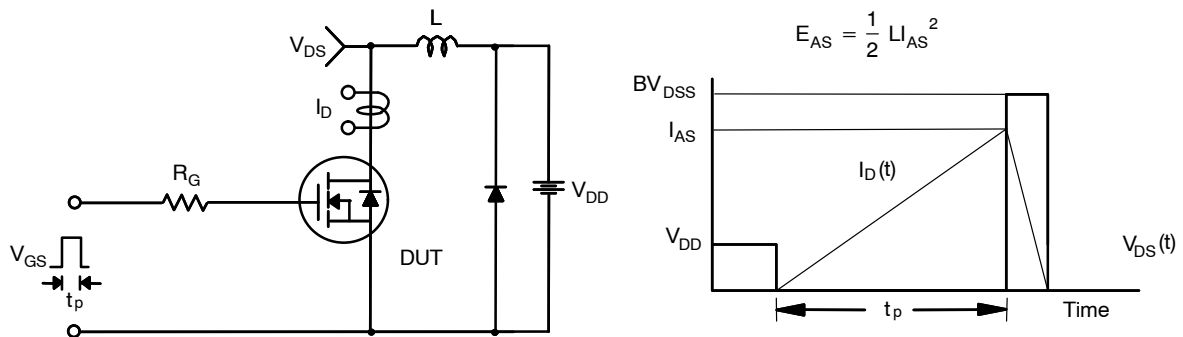

Figure 17. Unclamped Inductive Switching Test Circuit & Waveforms

FCP190N60, FCPF190N60

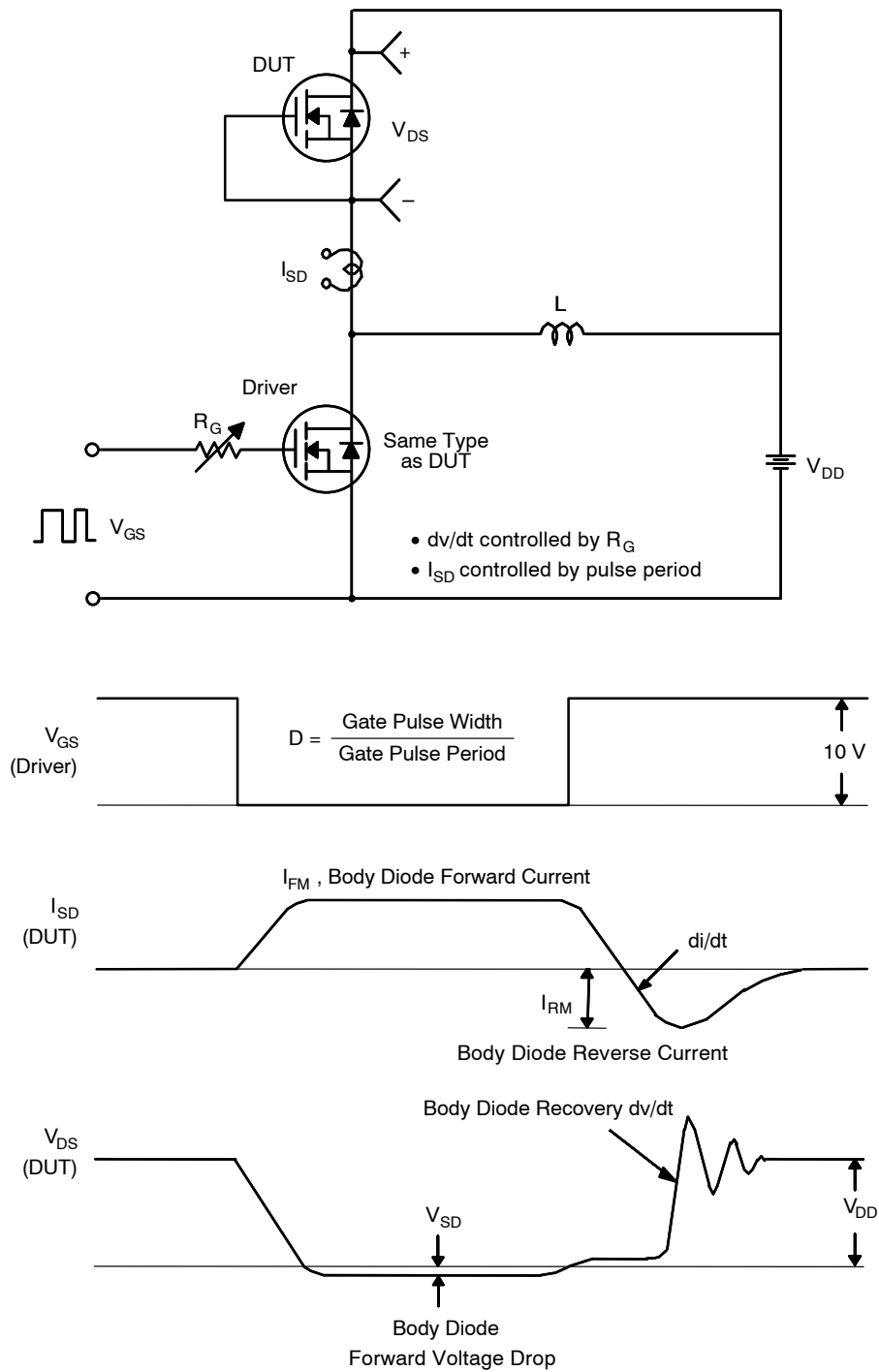

Figure 18. Peak Diode Recovery dv/dt Test Circuit & Waveforms

MECHANICAL CASE OUTLINE

PACKAGE DIMENSIONS

ON Semiconductor®



TO-220 Fullpack, 3-Lead / TO-220F-3SG CASE 221AT ISSUE B

DATE 19 JAN 2021



Scale 1:1

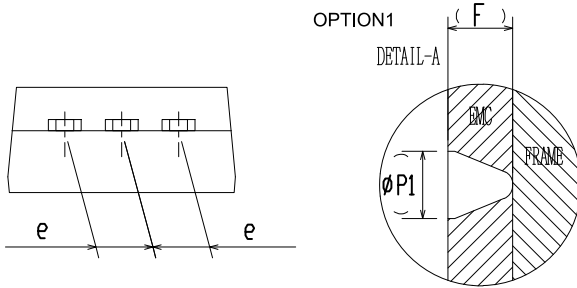
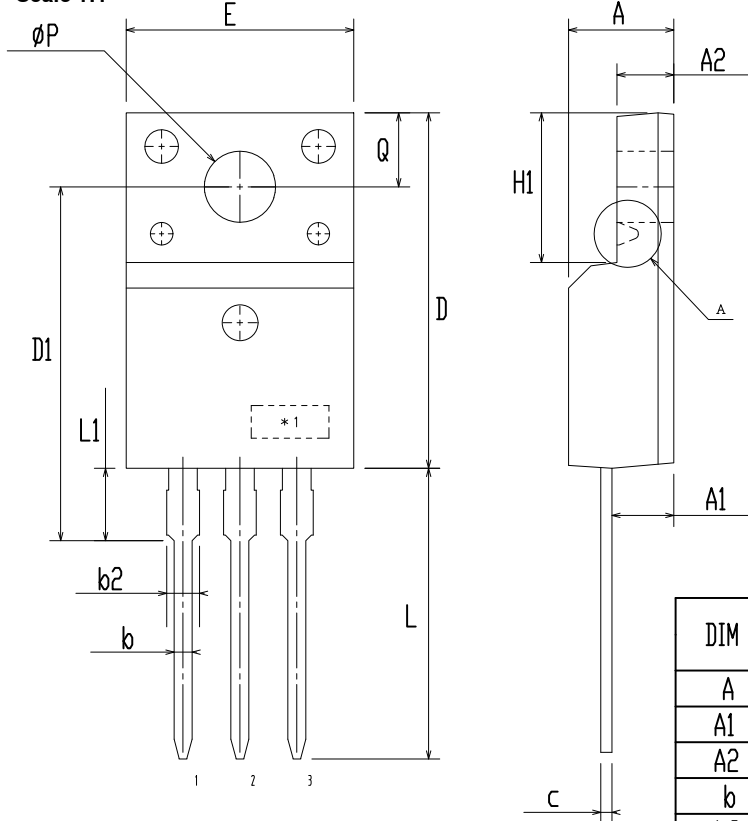

DIM	MILLIMETERS		
	MIN	NOM	MAX
A	4.50	4.70	4.90
A1	2.56	2.76	2.96
A2	2.34	2.54	2.74
b	0.70	0.80	0.90
b2	~	~	1.47
c	0.45	0.50	0.60
D	15.67	15.87	16.07
D1	15.60	15.80	16.00
E	9.96	10.16	10.36
e	2.34	2.54	2.74
F	~	0.84	~
H1	6.48	6.68	6.88
L	12.78	12.98	13.18
L1	3.03	3.23	3.43
∅ P	2.98	3.18	3.38
∅ P1	~	1.00	~
Q	3.20	3.30	3.40

NOTES:

- A. DIMENSION AND TOLERANCE AS ASME Y14.5-2009
- B. DIMENSIONS ARE EXCLUSIVE OF BURRS, MOLD FLASH AND TIE BAR PROTRUCTIONS.
- C. OPTION 1 - WITH SUPPORT PIN HOLE
OPTION 2 - NO SUPPORT PIN HOLE

DOCUMENT NUMBER:	98AON67439E	Electronic versions are uncontrolled except when accessed directly from the Document Repository. Printed versions are uncontrolled except when stamped "CONTROLLED COPY" in red.
DESCRIPTION:	TO-220 FULLPACK, 3-LEAD / TO-220F-3SG	PAGE 1 OF 1

ON Semiconductor and are trademarks of Semiconductor Components Industries, LLC dba ON Semiconductor or its subsidiaries in the United States and/or other countries. ON Semiconductor reserves the right to make changes without further notice to any products herein. ON Semiconductor makes no warranty, representation or guarantee regarding the suitability of its products for any particular purpose, nor does ON Semiconductor assume any liability arising out of the application or use of any product or circuit, and specifically disclaims any and all liability, including without limitation special, consequential or incidental damages. ON Semiconductor does not convey any license under its patent rights nor the rights of others.

MECHANICAL CASE OUTLINE

PACKAGE DIMENSIONS

ON Semiconductor®



Scale 1:1

TO-220-3LD CASE 340AT ISSUE A

DATE 03 OCT 2017



NOTES:

- A) REFERENCE JEDEC, TO-220, VARIATION AB
- B) ALL DIMENSIONS ARE IN MILLIMETERS.
- C) DIMENSIONS COMMON TO ALL PACKAGE SUPPLIERS EXCEPT WHERE NOTED [].
- D) LOCATION OF MOLDED FEATURE MAY VARY (LOWER LEFT CORNER, LOWER CENTER AND CENTER OF THE PACKAGE)
- E) DOES NOT COMPLY JEDEC STANDARD VALUE.
- F) "A1" DIMENSIONS AS BELOW:
SINGLE GAUGE = 0.51 - 0.61
DUAL GAUGE = 1.10 - 1.45
- G) PRESENCE IS SUPPLIER DEPENDENT
- H) SUPPLIER DEPENDENT MOLD LOCKING HOLES IN HEATSINK.

DOCUMENT NUMBER:	98AON13818G	Electronic versions are uncontrolled except when accessed directly from the Document Repository. Printed versions are uncontrolled except when stamped "CONTROLLED COPY" in red.
DESCRIPTION:	TO-220-3LD	PAGE 1 OF 1

ON Semiconductor and are trademarks of Semiconductor Components Industries, LLC dba ON Semiconductor or its subsidiaries in the United States and/or other countries. ON Semiconductor reserves the right to make changes without further notice to any products herein. ON Semiconductor makes no warranty, representation or guarantee regarding the suitability of its products for any particular purpose, nor does ON Semiconductor assume any liability arising out of the application or use of any product or circuit, and specifically disclaims any and all liability, including without limitation special, consequential or incidental damages. ON Semiconductor does not convey any license under its patent rights nor the rights of others.

onsemi, **Onsemi**, and other names, marks, and brands are registered and/or common law trademarks of Semiconductor Components Industries, LLC dba "**onsemi**" or its affiliates and/or subsidiaries in the United States and/or other countries. **onsemi** owns the rights to a number of patents, trademarks, copyrights, trade secrets, and other intellectual property. A listing of **onsemi**'s product/patent coverage may be accessed at www.onsemi.com/site/pdf/Patent-Marking.pdf. **onsemi** reserves the right to make changes at any time to any products or information herein, without notice. The information herein is provided "as-is" and **onsemi** makes no warranty, representation or guarantee regarding the accuracy of the information, product features, availability, functionality, or suitability of its products for any particular purpose, nor does **onsemi** assume any liability arising out of the application or use of any product or circuit, and specifically disclaims any and all liability, including without limitation special, consequential or incidental damages. Buyer is responsible for its products and applications using **onsemi** products, including compliance with all laws, regulations and safety requirements or standards, regardless of any support or applications information provided by **onsemi**. "Typical" parameters which may be provided in **onsemi** data sheets and/or specifications can and do vary in different applications and actual performance may vary over time. All operating parameters, including "Typicals" must be validated for each customer application by customer's technical experts. **onsemi** does not convey any license under any of its intellectual property rights nor the rights of others. **onsemi** products are not designed, intended, or authorized for use as a critical component in life support systems or any FDA Class 3 medical devices or medical devices with a same or similar classification in a foreign jurisdiction or any devices intended for implantation in the human body. Should Buyer purchase or use **onsemi** products for any such unintended or unauthorized application, Buyer shall indemnify and hold **onsemi** and its officers, employees, subsidiaries, affiliates, and distributors harmless against all claims, costs, damages, and expenses, and reasonable attorney fees arising out of, directly or indirectly, any claim of personal injury or death associated with such unintended or unauthorized use, even if such claim alleges that **onsemi** was negligent regarding the design or manufacture of the part. **onsemi** is an Equal Opportunity/Affirmative Action Employer. This literature is subject to all applicable copyright laws and is not for resale in any manner.

ADDITIONAL INFORMATION

TECHNICAL PUBLICATIONS:

Technical Library: www.onsemi.com/design/resources/technical-documentation
onsemi Website: www.onsemi.com

ONLINE SUPPORT: www.onsemi.com/support

For additional information, please contact your local Sales Representative at www.onsemi.com/support/sales