

MOSFET – N-Channel, UniFET™

250 V, 33 A, 94 mΩ

FDB33N25

Description

UniFET™ MOSFET is onsemi's high voltage MOSFET family based on planar stripe and DMOS technology. This MOSFET is tailored to reduce on-state resistance, and to provide better switching performance and higher avalanche energy strength. This device family is suitable for switching power converter applications such as power factor correction (PFC), flat panel display (FPD) TV power, ATX and electronic lamp ballasts.

Features

- $R_{DS(on)} = 94 \text{ m}\Omega$ (Max.) @ $V_{GS} = 10 \text{ V}$, $I_D = 16.5 \text{ A}$
- Low Gate Charge (Typ. 36.8 nC)
- Low C_{rss} (Typ. 39 pF)
- 100% Avalanche Tested
- These Devices are Pb-Free and are RoHS Compliant

Applications

- PDP TV
- Lighting
- Uninterruptible Power Supply
- AC-DC Power Supply

V_{DSS}	$R_{DS(on)}$ MAX	I_D MAX
250 V	94 mΩ @ 10 V	33 A

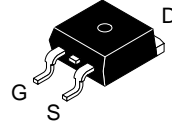

**D²PAK-3 (TO-263, 3-LEAD)
 CASE 418AJ**

MARKING DIAGRAM

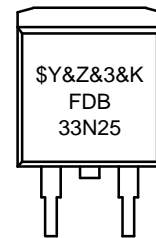

- \$Y = Logo
- &Z = Assembly Plant Code
- &3 = 3-Digit Date Code Format
- &K = 2-Digits Lot Run Traceability Code
- FDB33N25 = Device Code

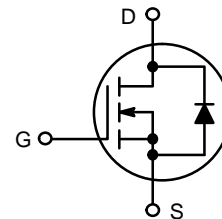

N-Channel

ORDERING INFORMATION

See detailed ordering and shipping information on page 7 of this data sheet.

FDB33N25

MOSFET MAXIMUM RATINGS ($T_C = 25^\circ\text{C}$ unless otherwise noted)

Symbol	Parameter	Value	Unit
V_{DSS}	Drain–Source Voltage	250	V
I_D	Drain Current	Continuous ($T_C = 25^\circ\text{C}$)	33
		Continuous ($T_C = 100^\circ\text{C}$)	20.4
I_{DM}	Drain Current	Pulsed (Note 1)	132
V_{GSS}	Gate–Source Voltage	± 30	V
E_{AS}	Single Pulsed Avalanche Energy (Note 2)	918	mJ
I_{AR}	Avalanche Current (Note 1)	33	A
E_{AR}	Repetitive Avalanche Energy (Note 1)	23.5	mJ
dv/dt	Peak Diode Recovery dv/dt (Note 3)	4.5	V/ns
P_D	Power Dissipation	($T_C = 25^\circ\text{C}$)	235
		Derate Above 25°C	1.89
T_J, T_{STG}	Operating and Storage Temperature Range	-55 to $+150$	$^\circ\text{C}$
T_L	Maximum Lead Temperature for Soldering, 1/8" from Case for 5 Seconds	300	$^\circ\text{C}$

Stresses exceeding those listed in the Maximum Ratings table may damage the device. If any of these limits are exceeded, device functionality should not be assumed, damage may occur and reliability may be affected.

1. Repetitive rating: pulse–width limited by maximum junction temperature.
2. $L = 1.35$ mH, $I_{AS} = 33$ A, $V_{DD} = 50$ V, $R_G = 25$ Ω , starting $T_J = 25^\circ\text{C}$.
3. $I_{SD} \leq 33$ A, $di/dt \leq 200$ A/ μs , $V_{DD} \leq BV_{DSS}$, starting $T_J = 25^\circ\text{C}$.

THERMAL CHARACTERISTICS

Symbol	Parameter	Value	Unit
$R_{\theta JC}$	Thermal Resistance, Junction–to–Case, Max.	0.53	$^\circ\text{C}/\text{W}$
$R_{\theta JA}$	Thermal Resistance, Junction–to–Ambient (1 in ² Pad of 2–oz Copper), Max.	40	
	Thermal Resistance, Junction–to–Ambient (Minimum Pad of 2–oz Copper), Max.	62.5	

FDB33N25

ELECTRICAL CHARACTERISTICS (T_C = 25°C unless otherwise noted)

Symbol	Parameter	Test Conditions	Min	Typ	Max	Unit
--------	-----------	-----------------	-----	-----	-----	------

OFF CHARACTERISTICS

BV _{DSS}	Drain–Source Breakdown Voltage	V _{GS} = 0 V, I _D = 250 μA	250	–	–	V
ΔBV _{DSS} / ΔT _J	Breakdown Voltage Temperature Coefficient	I _D = 250 μA, Referenced to 25°C	–	0.25	–	V/°C
I _{DSS}	Zero Gate Voltage Drain Current	V _{DS} = 250 V, V _{GS} = 0 V	–	–	1	μA
		V _{DS} = 200 V, T _C = 125°C	–	–	10	
I _{GSSF}	Gate–Body Leakage Current, Forward	V _{GS} = 30 V, V _{DS} = 0 V	–	–	100	nA
I _{GSSR}	Gate–Body Leakage Current, Reverse	V _{GS} = –30 V, V _{DS} = 0 V	–	–	–100	nA

ON CHARACTERISTICS

V _{GS(th)}	Gate Threshold Voltage	V _{GS} = V _{DS} , I _D = 250 μA	3.0	–	5.0	V
R _{DS(on)}	Static Drain–Source On–Resistance	V _{GS} = 10 V, I _D = 16.5 A	–	0.077	0.094	Ω
g _{FS}	Forward Transconductance	V _{DS} = 40 V, I _D = 16.5 A	–	26.6	–	S

DYNAMIC CHARACTERISTICS

C _{iss}	Input Capacitance	V _{DS} = 25 V, V _{GS} = 0 V, f = 1 MHz	–	1640	2135	pF
C _{oss}	Output Capacitance		–	330	430	pF
C _{rss}	Reverse Transfer Capacitance		–	39	59	pF

SWITCHING CHARACTERISTICS

t _{d(on)}	Turn–On Delay Time	V _{DD} = 125 V, I _D = 33 A, V _{GS} = 10 V, R _G = 25 Ω (Note 4)	–	35	80	ns
t _r	Turn–On Rise Time		–	230	470	ns
t _{d(off)}	Turn–Off Delay Time		–	75	160	ns
t _f	Turn–Off Fall Time		–	120	250	ns
Q _g	Total Gate Charge	V _{DS} = 200 V, I _D = 33 A, V _{GS} = 10 V (Note 4)	–	36.8	48	nC
Q _{gs}	Gate–Source Charge		–	10	–	nC
Q _{gd}	Gate–Drain Charge		–	17	–	nC

DRAIN–SOURCE DIODE CHARACTERISTICS AND MAXIMUM RATINGS

I _S	Maximum Continuous Drain–Source Diode Forward Current	–	–	33	A	
I _{SM}	Maximum Pulsed Drain–Source Diode Forward Current	–	–	132	A	
V _{SD}	Drain–Source Diode Forward Voltage	V _{GS} = 0 V, I _S = 33 A	–	–	1.4	V
t _{rr}	Reverse Recovery Time	V _{GS} = 0 V, I _S = 33 A, dI _F /dt = 100 A/μs	–	220	–	ns
Q _{rr}	Reverse Recovery Charge		–	1.71	–	μC

Product parametric performance is indicated in the Electrical Characteristics for the listed test conditions, unless otherwise noted. Product performance may not be indicated by the Electrical Characteristics if operated under different conditions.

4. Essentially independent of operating temperature typical characteristics.

TYPICAL PERFORMANCE CHARACTERISTICS

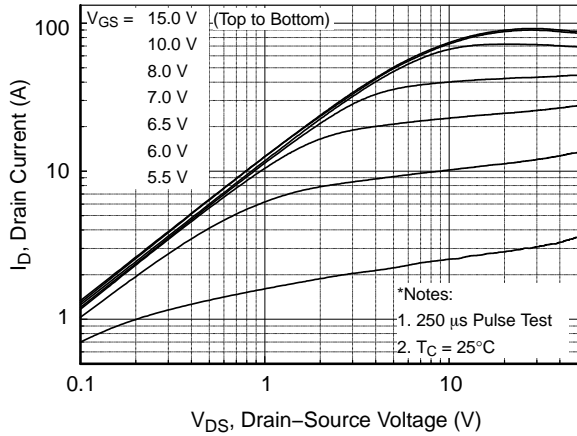

Figure 1. On-Region Characteristics

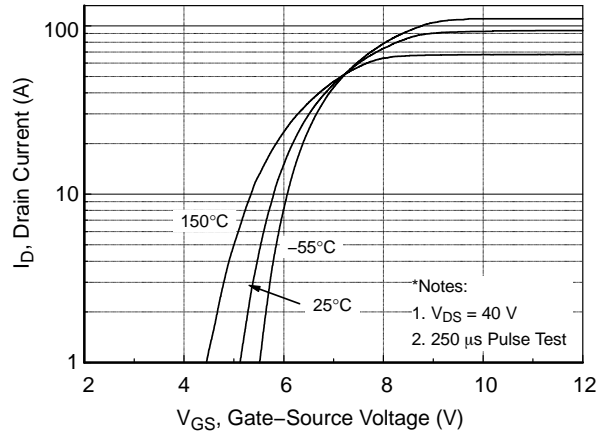

Figure 2. Transfer Characteristics

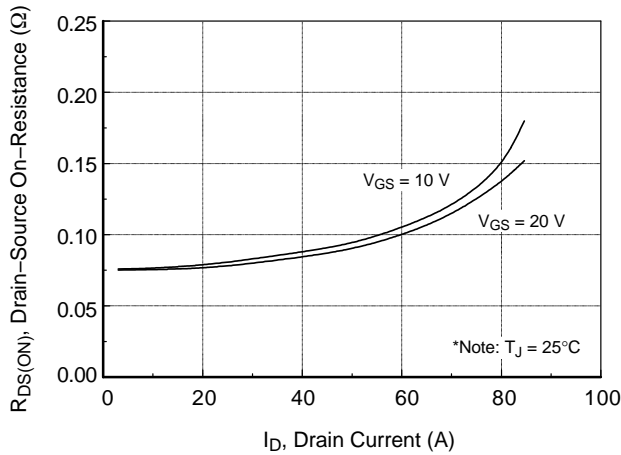

Figure 3. On-Resistance Variation vs. Drain Current and Gate Voltage

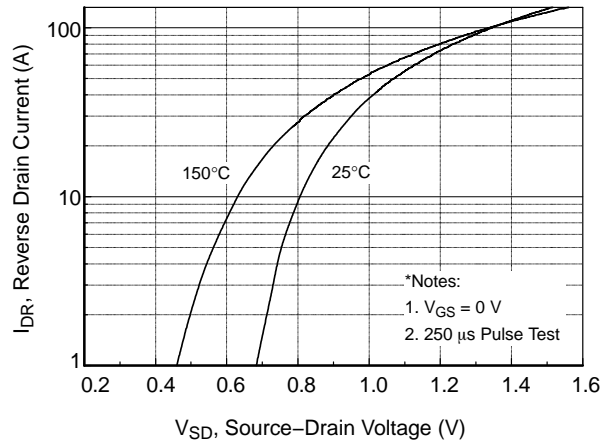

Figure 4. Body Diode Forward Voltage Variation vs. Source Current and Temperature

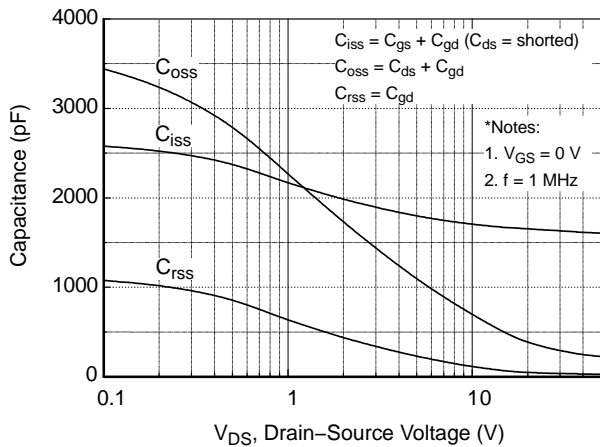

Figure 5. Capacitance Characteristics

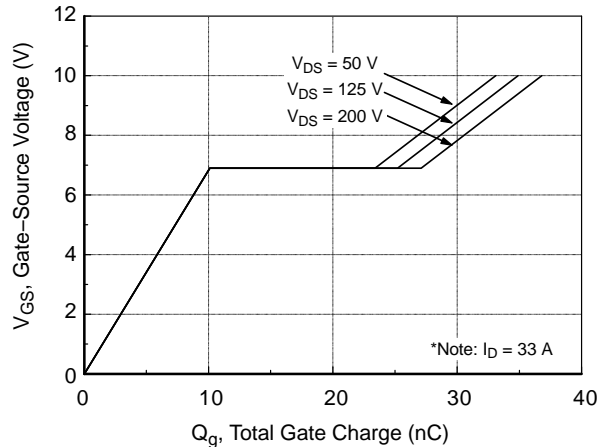

Figure 6. Gate Charge Characteristics

TYPICAL PERFORMANCE CHARACTERISTICS (continued)

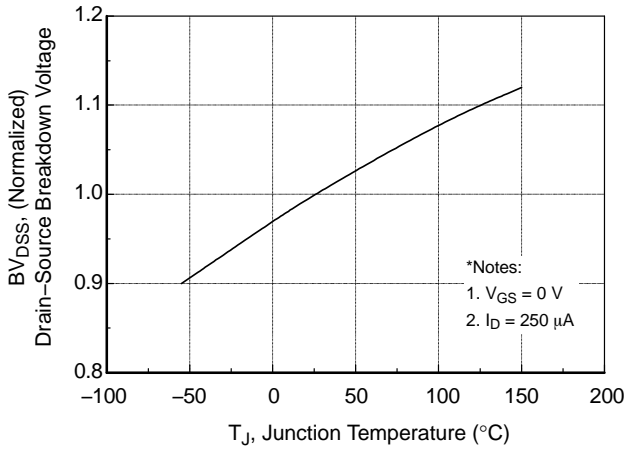

Figure 7. Breakdown Voltage Variation vs. Temperature

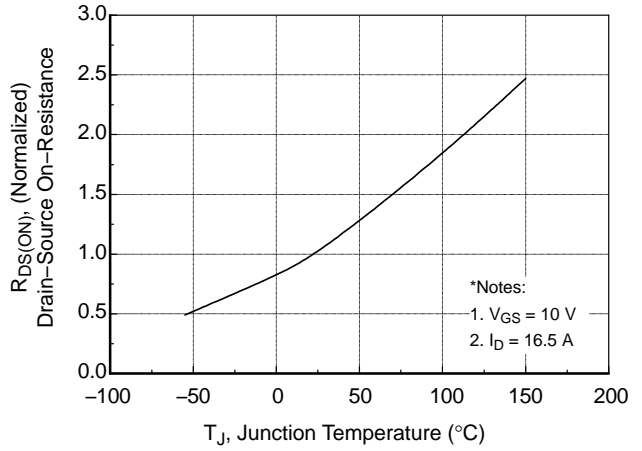

Figure 8. On-Resistance Variation vs. Temperature

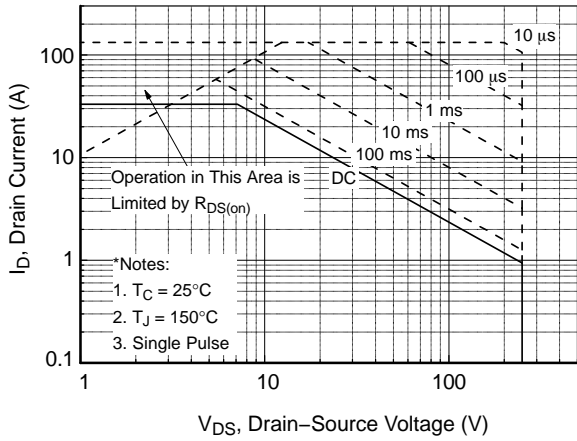

Figure 9. Maximum Safe Operating Area

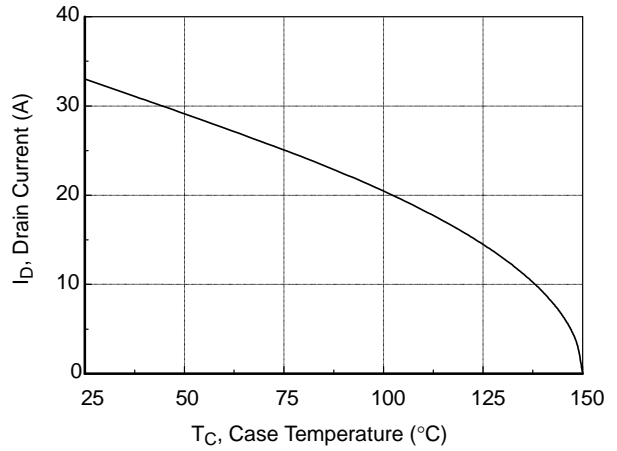

Figure 10. Maximum Drain Current vs. Case Temperature

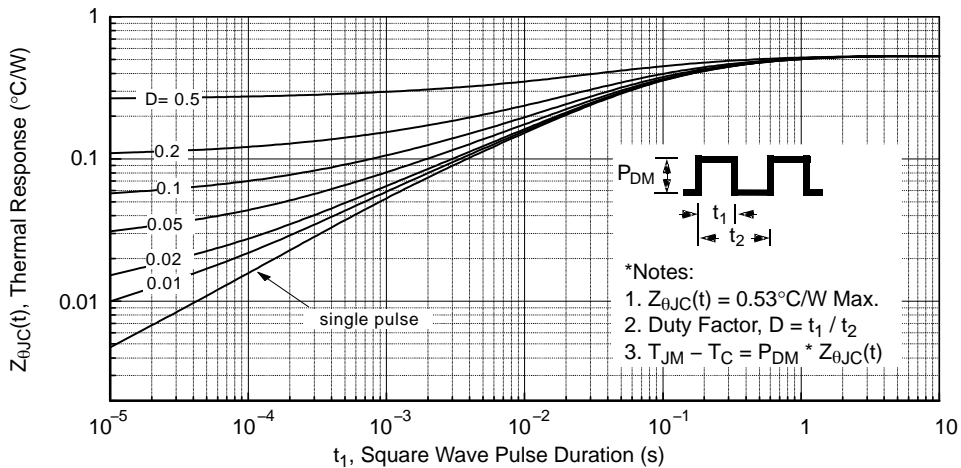

Figure 11. Transient Thermal Response Curve

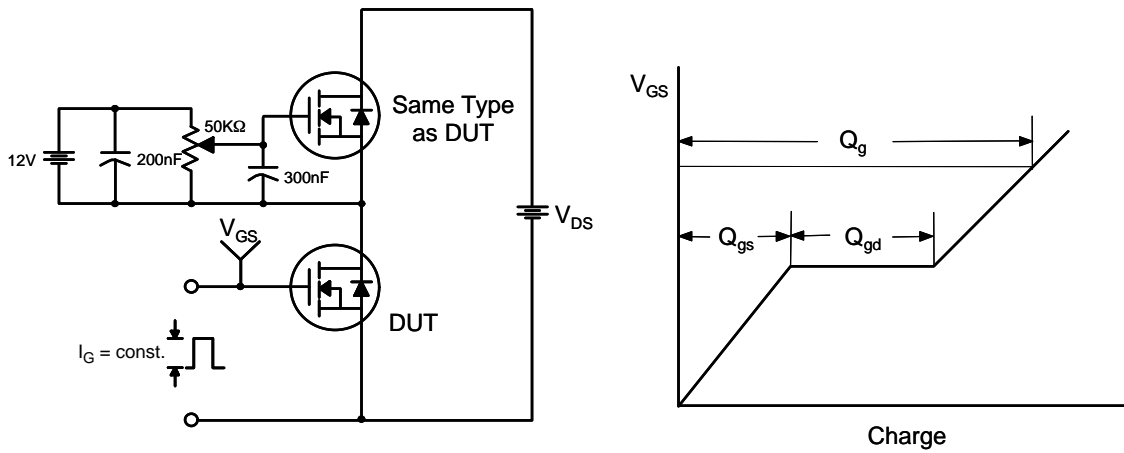

Figure 12. Gate Charge Test Circuit & Waveform

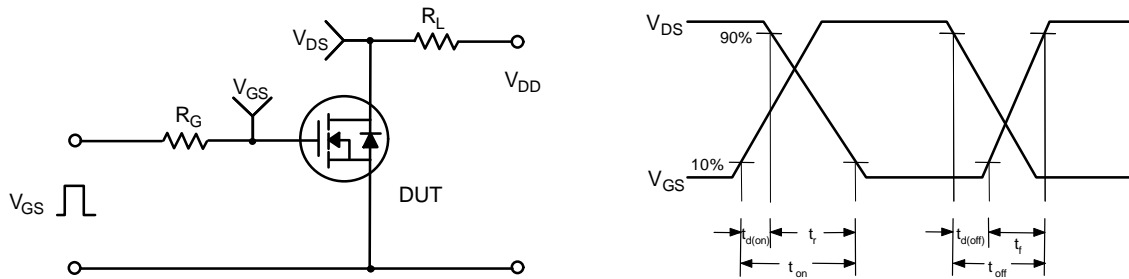

Figure 13. Resistive Switching Test Circuit & Waveforms

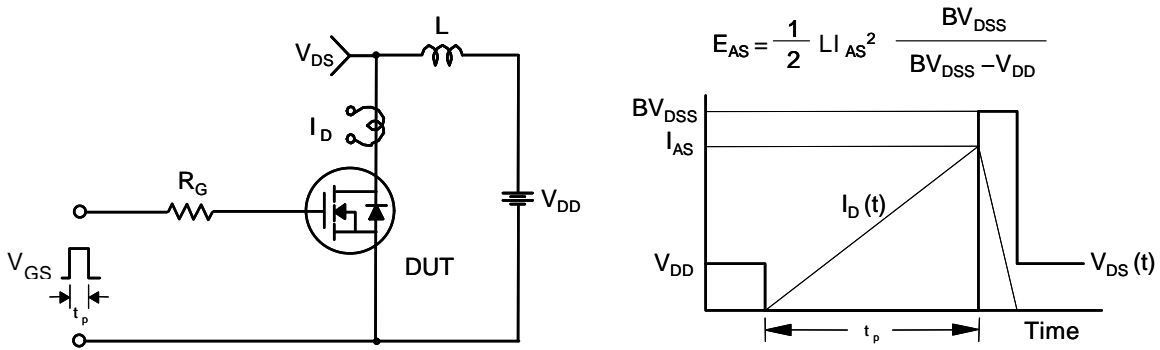

Figure 14. Unclamped Inductive Switching Test Circuit & Waveforms

FDB33N25

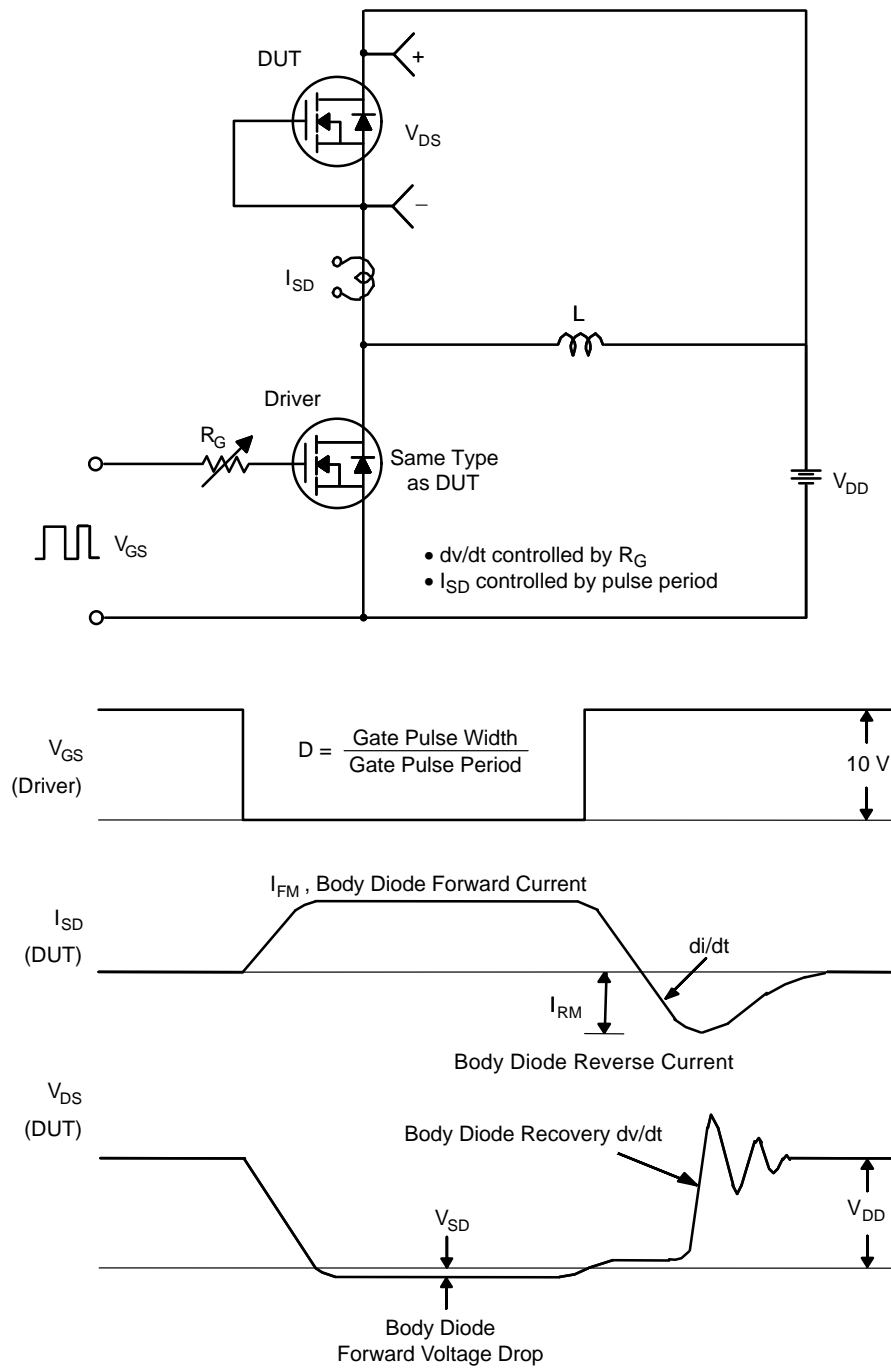

Figure 15. Peak Diode Recovery dv/dt Test Circuit & Waveforms

PACKAGE MARKING AND ORDERING INFORMATION

Part Number	Top Mark	Package	Shipping†
FDB33N25TM	FDB33N25	D ² -PAK	800 / Tape & Reel

†For information on tape and reel specifications, including part orientation and tape sizes, please refer to our Tape and Reel Packaging Specifications Brochure, BRD8011/D.

UniFET is a trademark of Semiconductor Components Industries, LLC dba "onsemi" or its affiliates and/or subsidiaries in the United States and/or other countries.

MECHANICAL CASE OUTLINE

PACKAGE DIMENSIONS

ON Semiconductor®

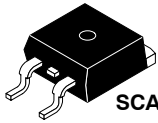

SCALE 1:1

D²PAK-3 (TO-263, 3-LEAD)

CASE 418AJ

ISSUE F

DATE 11 MAR 2021

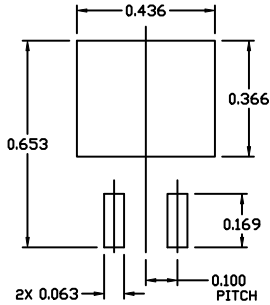

RECOMMENDED MOUNTING FOOTPRINT

■ For additional information on our Pb-Free strategy and soldering details, please download the ON Semiconductor Soldering and Mounting Techniques Reference Manual, SOLDERRM/D.

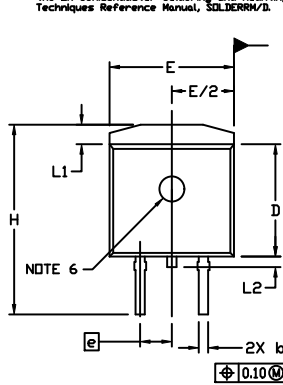

NOTES:

- DIMENSIONING AND TOLERANCING PER ASME Y14.5M, 2009.
- CONTROLLING DIMENSION: INCHES
- CHAMFER OPTIONAL.
- DIMENSIONS D AND E DO NOT INCLUDE MOLD FLASH. MOLD FLASH SHALL NOT EXCEED 0.005 PER SIDE. THESE DIMENSIONS ARE MEASURED AT THE OUTERMOST EXTREMES OF THE PLASTIC BODY AT DATUM H.
- THERMAL PAD CONTOUR IS OPTIONAL WITHIN DIMENSIONS E, L1, D1, AND E1.
- OPTIONAL MOLD FEATURE.
- ①, ② ... OPTIONAL CONSTRUCTION FEATURE CALL OUTS.

DIM	INCHES		MILLIMETERS	
	MIN.	MAX.	MIN.	MAX.
A	0.160	0.190	4.06	4.83
A1	0.000	0.010	0.00	0.25
b	0.020	0.039	0.51	0.99
c	0.012	0.029	0.30	0.74
c2	0.045	0.065	1.14	1.65
D	0.330	0.380	8.38	9.65
D1	0.260	---	6.60	---
E	0.380	0.420	9.65	10.67
E1	0.245	---	6.22	---
e	0.100	BSC	2.54	BSC
H	0.575	0.625	14.60	15.88
L	0.070	0.110	1.78	2.79
L1	---	0.066	---	1.68
L2	---	0.070	---	1.78
L3	0.010	BSC	0.25	BSC
M	0*	8*	0*	8*

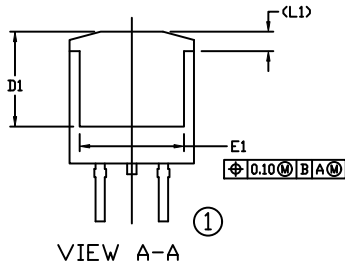
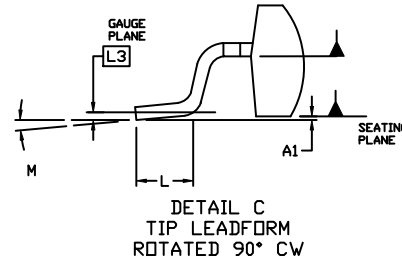
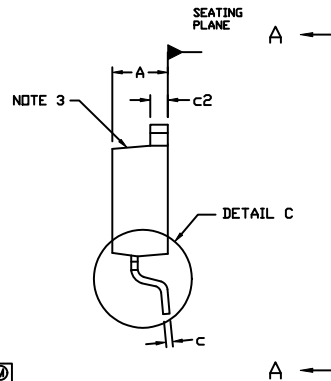

VIEW A-A

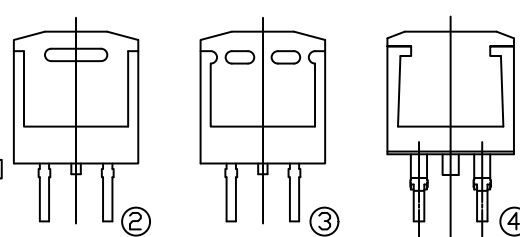

VIEW A-A
OPTIONAL CONSTRUCTIONS

GENERIC MARKING DIAGRAMS*

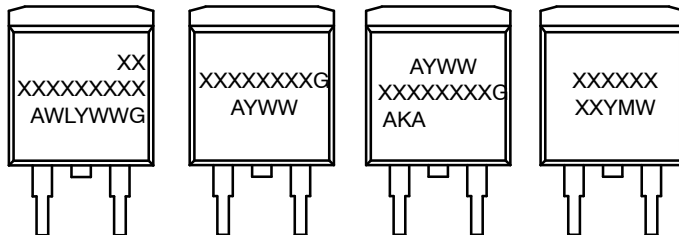

IC

Standard

Rectifier

SSG

- XXXXXX = Specific Device Code
- A = Assembly Location
- WL = Wafer Lot
- Y = Year
- WW = Work Week
- W = Week Code (SSG)
- M = Month Code (SSG)
- G = Pb-Free Package
- AKA = Polarity Indicator

*This information is generic. Please refer to device data sheet for actual part marking. Pb-Free indicator, "G" or microdot "▪", may or may not be present. Some products may not follow the Generic Marking.

DOCUMENT NUMBER:	98AON56370E	Electronic versions are uncontrolled except when accessed directly from the Document Repository. Printed versions are uncontrolled except when stamped "CONTROLLED COPY" in red.
DESCRIPTION:	D ² PAK-3 (TO-263, 3-LEAD)	PAGE 1 OF 1

ON Semiconductor and ON are trademarks of Semiconductor Components Industries, LLC dba ON Semiconductor or its subsidiaries in the United States and/or other countries. ON Semiconductor reserves the right to make changes without further notice to any products herein. ON Semiconductor makes no warranty, representation or guarantee regarding the suitability of its products for any particular purpose, nor does ON Semiconductor assume any liability arising out of the application or use of any product or circuit, and specifically disclaims any and all liability, including without limitation special, consequential or incidental damages. ON Semiconductor does not convey any license under its patent rights nor the rights of others.

onsemi, **Onsemi**, and other names, marks, and brands are registered and/or common law trademarks of Semiconductor Components Industries, LLC dba "**onsemi**" or its affiliates and/or subsidiaries in the United States and/or other countries. **onsemi** owns the rights to a number of patents, trademarks, copyrights, trade secrets, and other intellectual property. A listing of **onsemi**'s product/patent coverage may be accessed at www.onsemi.com/site/pdf/Patent-Marking.pdf. **onsemi** reserves the right to make changes at any time to any products or information herein, without notice. The information herein is provided "as-is" and **onsemi** makes no warranty, representation or guarantee regarding the accuracy of the information, product features, availability, functionality, or suitability of its products for any particular purpose, nor does **onsemi** assume any liability arising out of the application or use of any product or circuit, and specifically disclaims any and all liability, including without limitation special, consequential or incidental damages. Buyer is responsible for its products and applications using **onsemi** products, including compliance with all laws, regulations and safety requirements or standards, regardless of any support or applications information provided by **onsemi**. "Typical" parameters which may be provided in **onsemi** data sheets and/or specifications can and do vary in different applications and actual performance may vary over time. All operating parameters, including "Typicals" must be validated for each customer application by customer's technical experts. **onsemi** does not convey any license under any of its intellectual property rights nor the rights of others. **onsemi** products are not designed, intended, or authorized for use as a critical component in life support systems or any FDA Class 3 medical devices or medical devices with a same or similar classification in a foreign jurisdiction or any devices intended for implantation in the human body. Should Buyer purchase or use **onsemi** products for any such unintended or unauthorized application, Buyer shall indemnify and hold **onsemi** and its officers, employees, subsidiaries, affiliates, and distributors harmless against all claims, costs, damages, and expenses, and reasonable attorney fees arising out of, directly or indirectly, any claim of personal injury or death associated with such unintended or unauthorized use, even if such claim alleges that **onsemi** was negligent regarding the design or manufacture of the part. **onsemi** is an Equal Opportunity/Affirmative Action Employer. This literature is subject to all applicable copyright laws and is not for resale in any manner.

ADDITIONAL INFORMATION

TECHNICAL PUBLICATIONS:

Technical Library: www.onsemi.com/design/resources/technical-documentation
onsemi Website: www.onsemi.com

ONLINE SUPPORT: www.onsemi.com/support

For additional information, please contact your local Sales Representative at www.onsemi.com/support/sales