

FDBL9403L-F085

Single N-Channel Power MOSFET

40 V, 240 A, 0.72 mΩ

Features

- Small Footprint (TOLL) for Compact Design
- Low $R_{DS(on)}$ to Minimize Conduction Losses
- Low Q_G and Capacitance to Minimize Driver Losses
- AEC-Q101 Qualified and PPAP Capable
- These Devices are Pb-Free, Halogen Free/BFR Free and are RoHS Compliant

MAXIMUM RATINGS ($T_J = 25^\circ\text{C}$ unless otherwise noted)

| Parameter | | Symbol | Value | Unit | |
|--|--|---------------------------|-------------|------------------|---|
| Drain-to-Source Voltage | | V_{DSS} | 40 | V | |
| Gate-to-Source Voltage | | V_{GS} | ± 20 | V | |
| Continuous Drain Current $R_{\theta JC}$ (Notes 1, 3) | Steady State | $T_C = 25^\circ\text{C}$ | I_D | 240 | A |
| | | | | | |
| Power Dissipation $R_{\theta JC}$ (Note 1) | Steady State | $T_C = 25^\circ\text{C}$ | P_D | 357.1 | W |
| | | $T_C = 100^\circ\text{C}$ | | 178.6 | |
| Continuous Drain Current $R_{\theta JA}$ (Notes 1, 2, 3) | Steady State | $T_C = 25^\circ\text{C}$ | I_D | 53.3 | A |
| | | $T_C = 100^\circ\text{C}$ | | 37.7 | |
| Power Dissipation $R_{\theta JA}$ (Notes 1, 2) | Steady State | $T_C = 25^\circ\text{C}$ | P_D | 3.5 | W |
| | | $T_C = 100^\circ\text{C}$ | | 1.7 | |
| Pulsed Drain Current | $T_C = 25^\circ\text{C}, t_p = 10 \mu\text{s}$ | I_{DM} | 2113 | A | |
| Operating Junction and Storage Temperature Range | | T_J, T_{stg} | -55 to +175 | $^\circ\text{C}$ | |
| Source Current (Body Diode) | | I_S | 100 | A | |
| Single Pulse Drain-to-Source Avalanche Energy ($I_{L(pk)} = 79 \text{ A}, L = 0.2 \text{ mH}$) | | E_{AS} | 624 | mJ | |
| Lead Temperature for Soldering Purposes (1/8" from case for 10 s) | | T_L | 260 | $^\circ\text{C}$ | |

Stresses exceeding those listed in the Maximum Ratings table may damage the device. If any of these limits are exceeded, device functionality should not be assumed, damage may occur and reliability may be affected.

1. The entire application environment impacts the thermal resistance values shown, they are not constants and are only valid for the particular conditions noted. Current is limited by bondwire configuration.
2. Surface-mounted on FR4 board using a 650 mm², 2 oz. Cu pad.
3. Maximum current for pulses as long as 1 second is higher but is dependent on pulse duration and duty cycle.



ON Semiconductor®

www.onsemi.com

| $V_{(BR)DSS}$ | $R_{DS(ON)} \text{ MAX}$ | $I_D \text{ MAX}$ |
|---------------|--------------------------|-------------------|
| 40 V | 0.72 mΩ @ 10 V | 80 A |
| | 0.98 mΩ @ 4.5 V | |

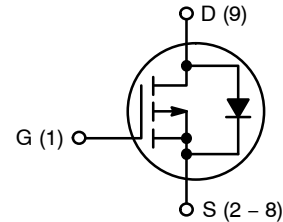

N-CHANNEL MOSFET

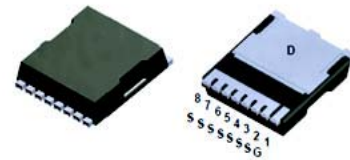

H-PSOF8L
CASE 100CU

MARKING DIAGRAM

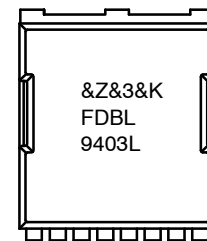

&Z = Assembly Plant Code
 &3 = Numeric Date Code
 &K = Lot Code
 FDBL9403L = Specific Device Code

ORDERING INFORMATION

See detailed ordering and shipping information on page 7 of this data sheet.

FDBL9403L–F085

Table 1. THERMAL CHARACTERISTICS

| Symbol | Parameter | Value | Unit |
|-----------------|---|-------|------|
| $R_{\theta JC}$ | Junction-to-Case – Steady State | 0.42 | °C/W |
| $R_{\theta JA}$ | Junction-to-Ambient – Steady State (Note 4) | 43 | |

4. Surface-mounted on FR4 board using a 650 mm², 2 oz. Cu pad.

Table 2. ELECTRICAL CHARACTERISTICS ($T_J = 25^\circ\text{C}$ unless otherwise noted)

| Symbol | Parameter | Test Condition | Min | Typ | Max | Unit |
|--------|-----------|----------------|-----|-----|-----|------|
|--------|-----------|----------------|-----|-----|-----|------|

OFF CHARACTERISTICS

| | | | | | | |
|-------------------|---|---|----|------|------|---------------------|
| $V_{(BR)DSS}$ | Drain-to-Source Breakdown Voltage | $I_D = 250 \mu\text{A}, V_{GS} = 0 \text{ V}$ | 40 | – | – | V |
| $V_{(BR)DSS}/T_J$ | Drain-to-Source Breakdown Voltage Temperature Coefficient | | – | 22.5 | – | mV/°C |
| I_{DSS} | Zero Gate Voltage Drain Current | $V_{DS} = 40 \text{ V}, V_{GS} = 0 \text{ V}, T_J = 25^\circ\text{C}$ $V_{DS} = 40 \text{ V}, V_{GS} = 0 \text{ V}, T_J = 175^\circ\text{C}$ | – | – | 1 | μA mA |
| I_{GSS} | Zero Gate Voltage Drain Current | $V_{DS} = 0 \text{ V}, V_{GS} = \pm 20 \text{ V}$ | – | – | ±100 | nA |

ON CHARACTERISTICS (Note 5)

| | | | | | | |
|------------------|-----------------------------------|--|---|------|------|-------|
| $V_{GS(th)}$ | Gate Threshold Voltage | $V_{GS} = V_{DS}, I_D = 250 \mu\text{A}$ | 1 | 1.75 | 3 | V |
| $V_{GS(th)}/T_J$ | Threshold Temperature Coefficient | | – | –5.6 | – | mV/°C |
| $R_{DS(on)}$ | Drain-to-Source On Resistance | $V_{GS} = 10 \text{ V}, I_D = 80 \text{ A}$ | – | 0.59 | 0.72 | mΩ |
| | | $V_{GS} = 4.5 \text{ V}, I_D = 40 \text{ A}$ | – | 0.76 | 0.98 | |

CHARGES, CAPACITANCES & GATE RESISTANCE

| | | | | | | |
|--------------|-------------------------------|---|---|-------|---|----|
| C_{iss} | Input Capacitance | $V_{GS} = 0 \text{ V}, f = 1 \text{ MHz}, V_{DS} = 20 \text{ V}$ | – | 14100 | – | pF |
| C_{oss} | Output Capacitance | | – | 4070 | – | |
| C_{rss} | Reverse Transfer Capacitance | | – | 300 | – | |
| R_g | Gate Resistance | $V_{GS} = 0.5 \text{ V}, f = 1 \text{ MHz}$ | – | 3.3 | – | Ω |
| $Q_{g(tot)}$ | Total Gate Charge | $V_{GS} = 4.5 \text{ V}, V_{DS} = 32 \text{ V}, I_D = 80 \text{ A}$ | – | 97 | – | nC |
| | | $V_{GS} = 10 \text{ V}, V_{DS} = 32 \text{ V}, I_D = 80 \text{ A}$ | – | 203 | – | |
| $Q_{g(th)}$ | Threshold Gate Charge | $V_{GS} = 0 \text{ V to } 1 \text{ V}$ | – | 13 | – | |
| Q_{gs} | Gate-to-Source Gate Charge | $V_{DD} = 32 \text{ V}, I_D = 80 \text{ A}$ | – | 40 | – | |
| Q_{gd} | Gate-to-Drain “Miller” Charge | | – | 27 | – | |
| V_{GP} | Plateau Voltage | | – | 3 | – | V |

SWITCHING CHARACTERISTICS

| | | | | | | |
|--------------|---------------------|---|---|-----|---|----|
| $t_{d(on)}$ | Turn-On Delay Time | $V_{DD} = 20 \text{ V}, I_D = 80 \text{ A},$ $V_{GS} = 10 \text{ V}, R_{GEN} = 6 \Omega$ | – | 21 | – | ns |
| t_r | Turn-On Rise Time | | – | 42 | – | |
| $t_{d(off)}$ | Turn-Off Delay Time | | – | 288 | – | |
| t_f | Turn-Off Fall Time | | – | 101 | – | |

DRAIN-SOURCE DIODE CHARACTERISTICS

| | | | | | | |
|----------|-------------------------------|--|---|------|------|----|
| V_{SD} | Source-to-Drain Diode Voltage | $I_{SD} = 80 \text{ A}, V_{GS} = 0 \text{ V}$ | – | 0.79 | 1.25 | V |
| | | $I_{SD} = 40 \text{ A}, V_{GS} = 0 \text{ V}$ | – | 0.75 | 1.2 | |
| t_{rr} | Reverse Recovery Time | $V_{GS} = 0 \text{ V}, dI_{SD}/dt = 100 \text{ A}/\mu\text{s}, I_S = 80 \text{ A}$ | – | 96 | – | ns |
| t_a | Charge Time | | – | 46 | – | |
| t_b | Discharge Time | | – | 50 | – | |
| Q_{rr} | Reverse Recovery Charge | | – | 130 | – | |

Product parametric performance is indicated in the Electrical Characteristics for the listed test conditions, unless otherwise noted. Product performance may not be indicated by the Electrical Characteristics if operated under different conditions.

5. Pulse Test: pulse width $\leq 300 \mu\text{s}$, duty cycle $\leq 2\%$.

6. Switching characteristics are independent of operating junction temperatures.

TYPICAL CHARACTERISTICS

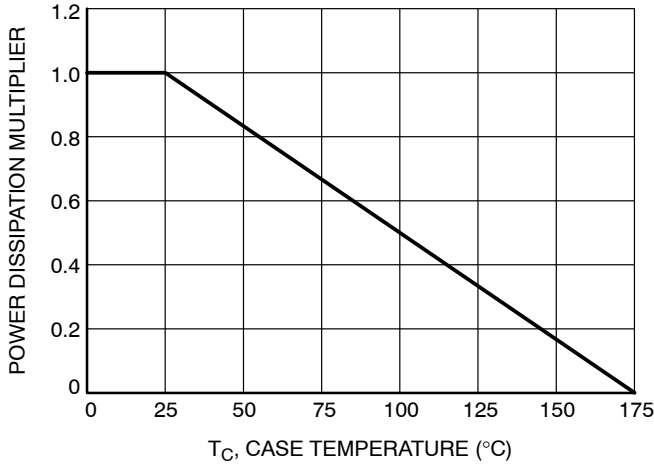

Figure 1. Normalized Power Dissipation vs. Case Temperature

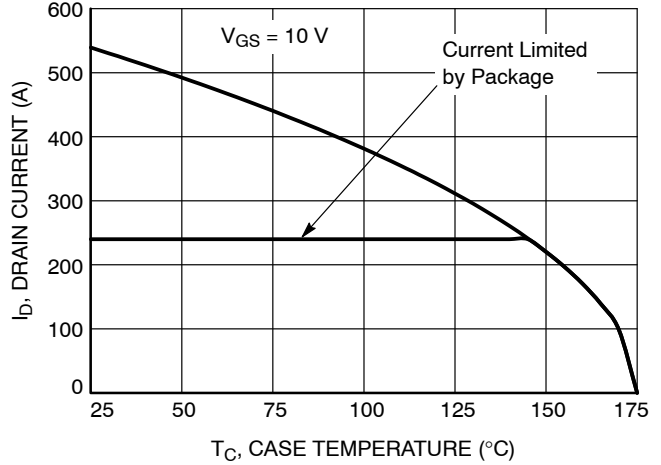

Figure 2. Maximum Continuous Drain Current vs. Case Temperature

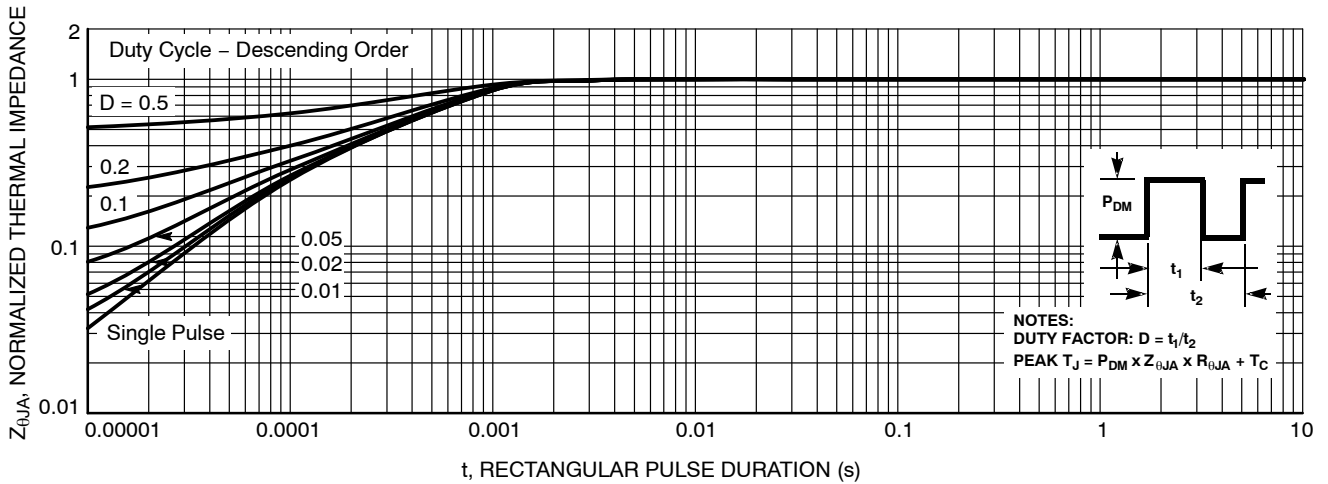

Figure 3. Normalized Maximum Transient Thermal Impedance

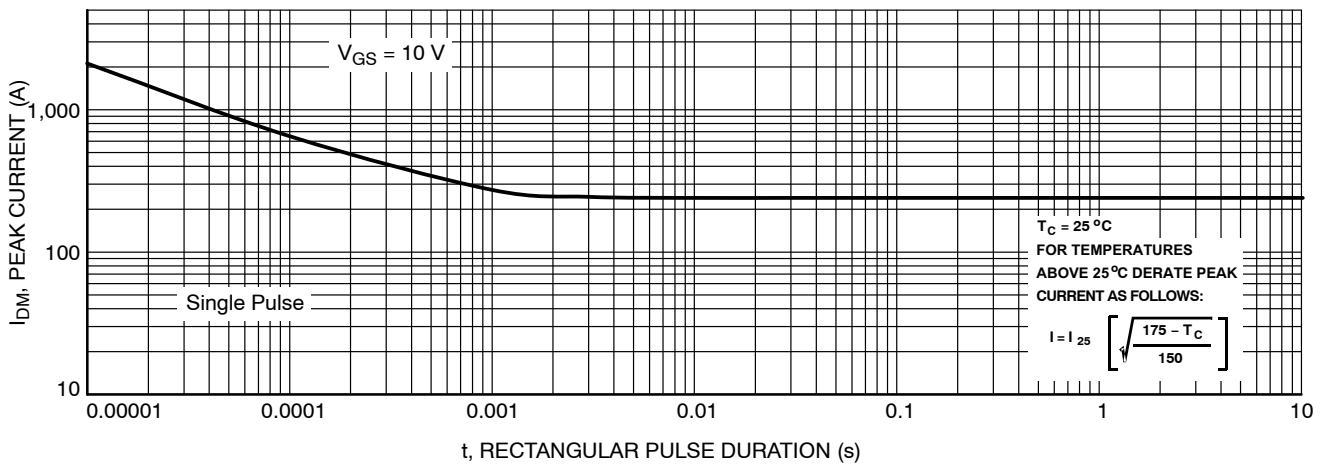

Figure 4. Peak Current Capability

TYPICAL CHARACTERISTICS

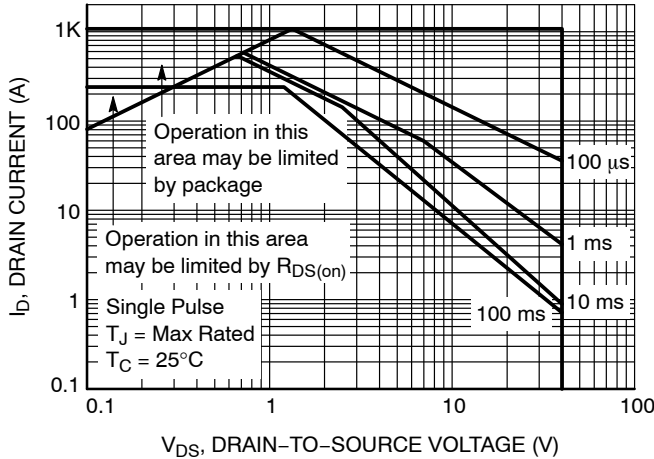

Figure 5. Forward Bias Safe Operating Area

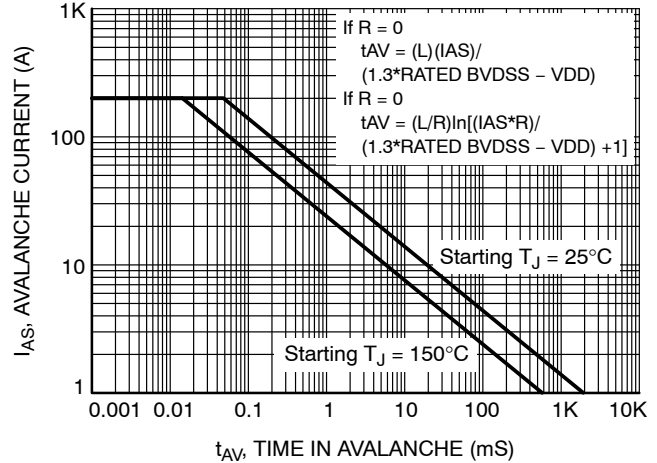

Figure 6. Unclamped Inductive Switching Capability

Note: Refer to ON Semiconductor Application Notes AN7514 and AN7515

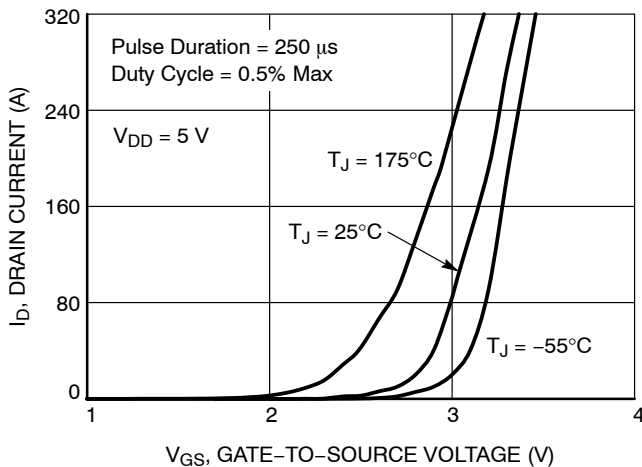

Figure 7. Transfer Characteristics

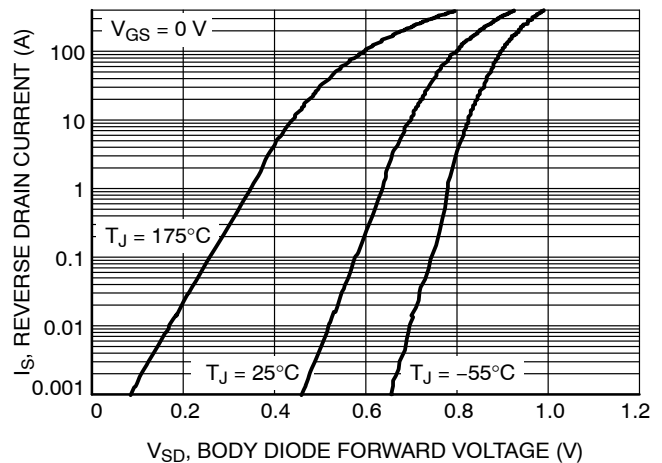

Figure 8. Forward Diode Characteristics

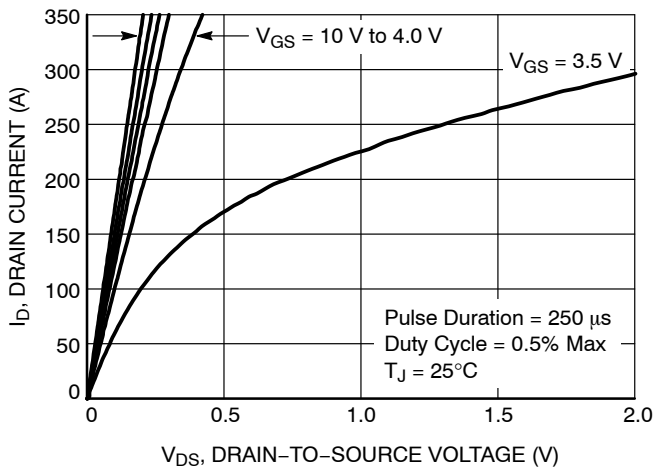

Figure 9. Saturation Characteristics

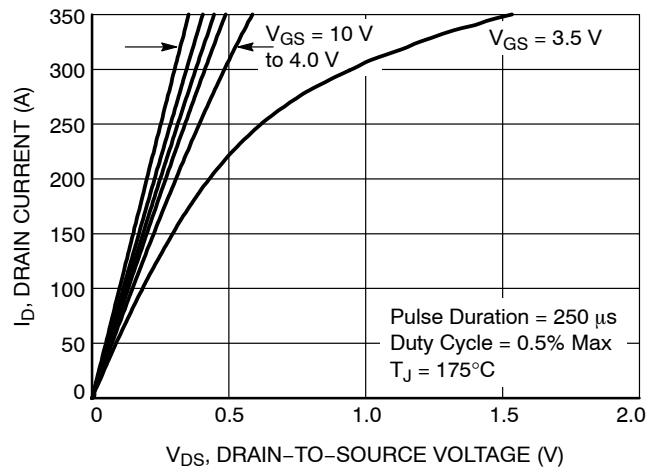

Figure 10. Saturation Characteristics

TYPICAL CHARACTERISTICS

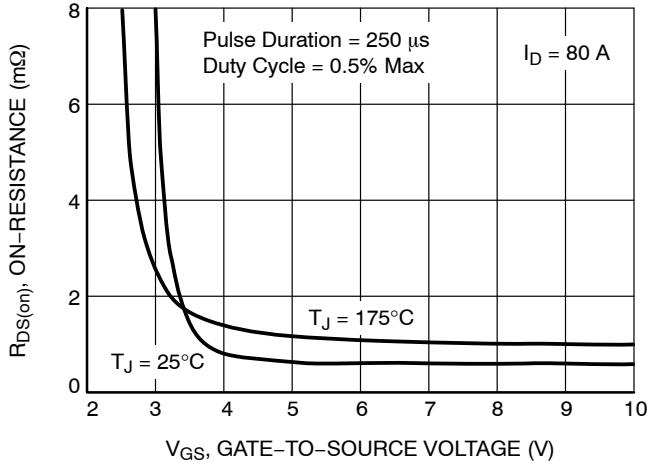

Figure 11. $R_{DS(on)}$ vs. Gate Voltage

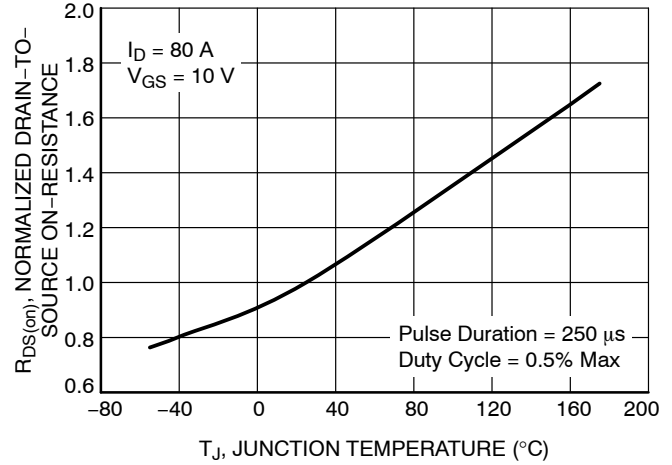

Figure 12. Normalized $R_{DS(on)}$ vs. Junction Temperature

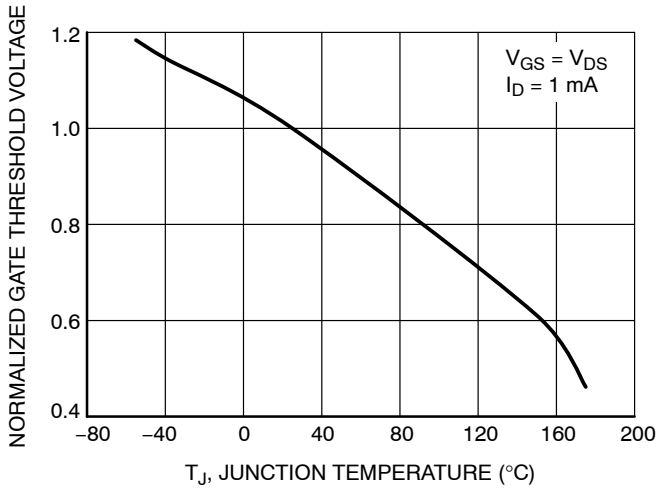

Figure 13. Normalized Gate Threshold Voltage vs. Temperature

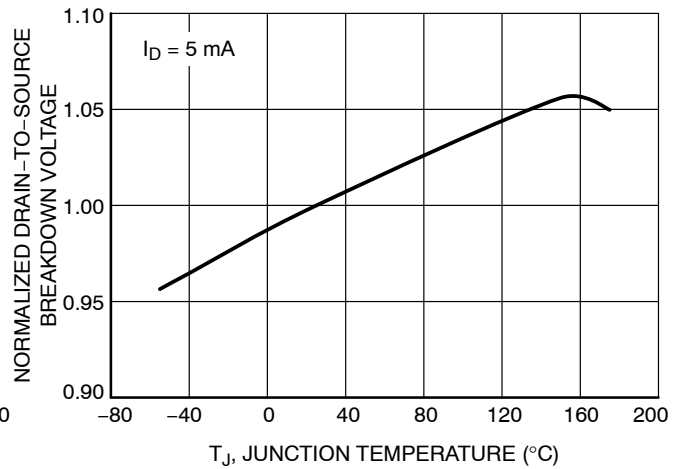

Figure 14. Normalized Drain-to-Source Breakdown Voltage vs. Junction Temperature

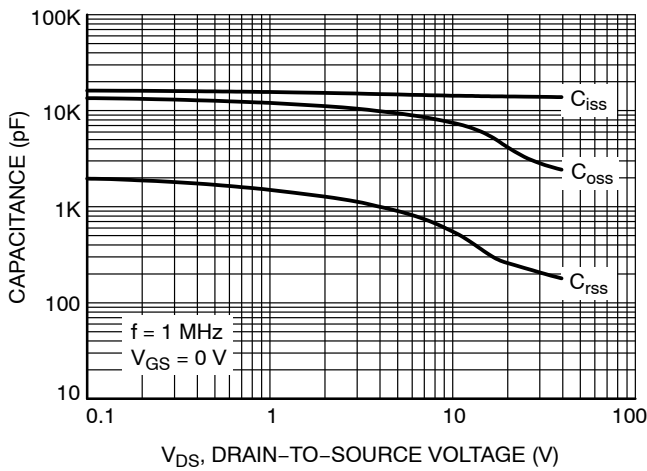

Figure 15. Capacitance vs. Drain-to-Source Voltage

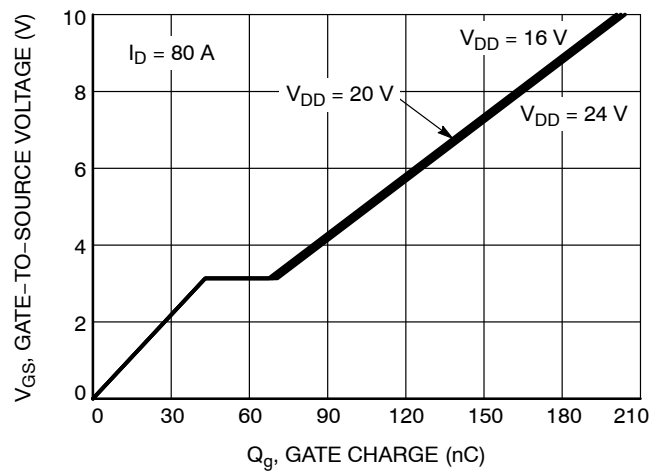
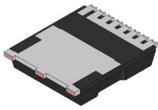

Figure 16. Gate Charge vs. Gate-to-Source Voltage

FDBL9403L-F085

PACKAGE MARKING AND ORDERING INFORMATION

| Device | Marking | Package | Reel Size | Tape Width | Quantity |
|----------------|-----------|--------------------------------------|-----------|------------|------------|
| FDBL9403L-F085 | FDBL9403L | H-PSOF8L (Pb-Free / Halogen Free) | 13" | 24 mm | 2000 Units |



H-PSOF8L 11.68x9.80x2.30, 1.20P
CASE 100CU
ISSUE F

DATE 30 JUL 2024

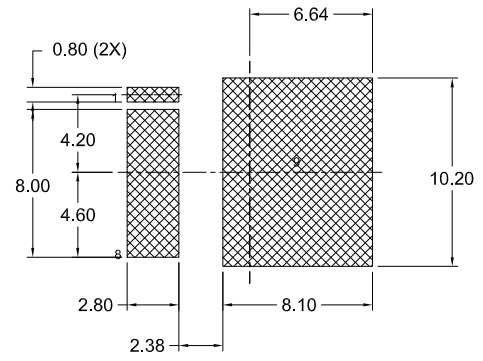
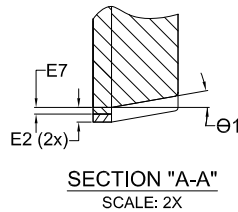
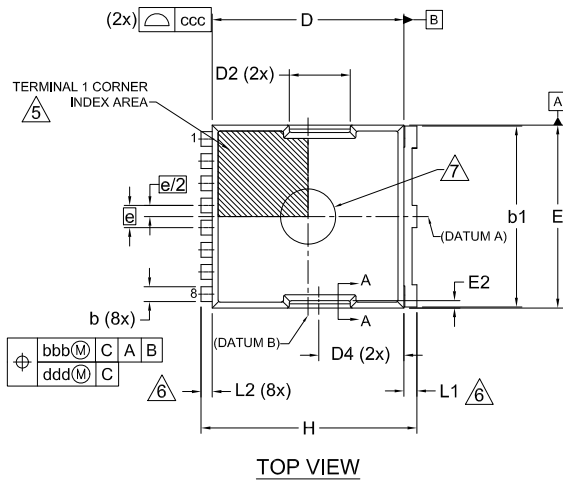

LAND PATTERN RECOMMENDATION
*FOR ADDITIONAL INFORMATION ON OUR PB-FREE STRATEGY AND SOLDERING DETAILS, PLEASE DOWNLOAD THE ONSEMI SOLDERING AND MOUNTING TECHNIQUES REFERENCE MANUAL, SOLDERRM/D.

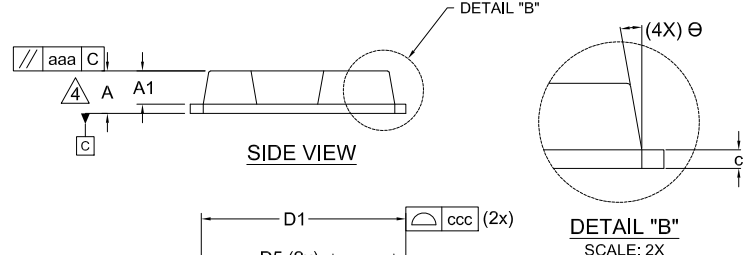

- NOTES:
1. PACKAGE STANDARD REFERENCE: JEDEC MO-299, ISSUE B.
 2. DIMENSIONING AND TOLERANCING PER ASME Y14.5M, 2018.
 3. "e" REPRESENTS THE TERMINAL PITCH.
 4. THIS DIMENSION INCLUDES ENCAPSULATION THICKNESS "A1", AND PACKAGE BODY THICKNESS, BUT DOES NOT INCLUDE ATTACHED FEATURES, e.g., EXTERNAL OR CHIP CAPACITORS. AN INTEGRAL HEATSLUG IS NOT CONSIDERED AS ATTACHED FEATURE.
 5. A VISUAL INDEX FEATURE MUST BE LOCATED WITHIN THE HATCHED AREA.
 6. DIMENSIONS b1,L1,L2 APPLY TO PLATED TERMINALS.
 7. THE LOCATION AND SIZE OF EJECTOR MARKS ARE OPTIONAL.
 8. THE LOCATION AND NUMBER OF FUSED LEADS ARE OPTIONAL.

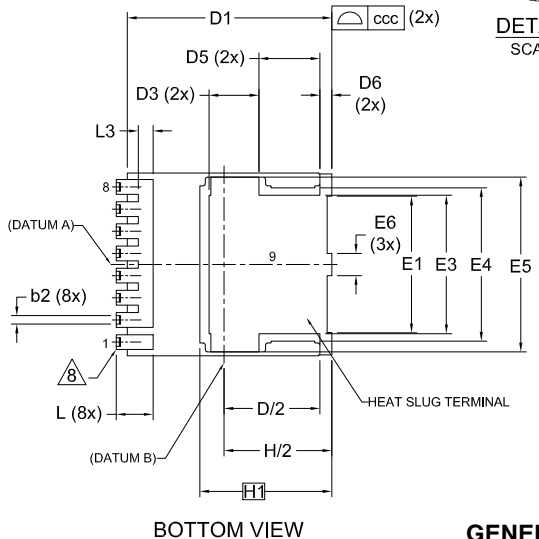

| DIM | MILLIMETERS | | |
|-----|-------------|-------|-------|
| | MIN. | NOM. | MAX. |
| A | 2.20 | 2.30 | 2.40 |
| A1 | 1.70 | 1.80 | 1.90 |
| b | 0.70 | 0.80 | 0.90 |
| b1 | 9.70 | 9.80 | 9.90 |
| b2 | 0.35 | 0.45 | 0.55 |
| c | 0.40 | 0.50 | 0.60 |
| D | 10.28 | 10.38 | 10.48 |
| D/2 | 5.09 | 5.19 | 5.29 |
| D1 | 10.98 | 11.08 | 11.18 |
| D2 | 3.20 | 3.30 | 3.40 |
| D3 | 2.60 | 2.70 | 2.80 |
| D4 | 4.45 | 4.55 | 4.65 |
| D5 | 3.20 | 3.30 | 3.40 |
| D6 | 0.55 | 0.65 | 0.75 |
| E | 9.80 | 9.90 | 10.00 |
| E1 | 7.30 | 7.40 | 7.50 |
| E2 | 0.30 | 0.40 | 0.50 |
| E3 | 7.40 | 7.50 | 7.60 |
| E4 | 8.20 | 8.30 | 8.40 |

| DIM | MILLIMETERS | | |
|-----|-------------|-------|-------|
| | MIN. | NOM. | MAX. |
| E5 | 9.36 | 9.46 | 9.56 |
| E6 | 1.10 | 1.20 | 1.30 |
| E7 | 0.15 | 0.18 | 0.21 |
| e | 1.20 BSC | | |
| e/2 | 0.60 BSC | | |
| H | 11.58 | 11.68 | 11.78 |
| H/2 | 5.74 | 5.84 | 5.94 |
| H1 | 7.15 BSC | | |
| L | 1.90 | 2.00 | 2.10 |
| L1 | 0.60 | 0.70 | 0.80 |
| L2 | 0.50 | 0.60 | 0.70 |
| L3 | 0.70 | 0.80 | 0.90 |
| θ | 10° REF | | |
| θ1 | 10° REF | | |
| aaa | 0.20 | | |
| bbb | 0.25 | | |
| ccc | 0.20 | | |
| ddd | 0.20 | | |
| eee | 0.10 | | |

GENERIC MARKING DIAGRAM*

A = Assembly Location
Y = Year
WW = Work Week
ZZ = Assembly Lot Code
XXXX = Specific Device Code

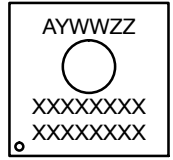

*This information is generic. Please refer to device data sheet for actual part marking. Pb-Free indicator, "G" or microdot "•", may or may not be present. Some products may not follow the Generic Marking.

| | | |
|------------------|---------------------------------|--|
| DOCUMENT NUMBER: | 98AON13813G | Electronic versions are uncontrolled except when accessed directly from the Document Repository. Printed versions are uncontrolled except when stamped "CONTROLLED COPY" in red. |
| DESCRIPTION: | H-PSOF8L 11.68x9.80x2.30, 1.20P | PAGE 1 OF 1 |

onsemi and onsemi are trademarks of Semiconductor Components Industries, LLC dba onsemi or its subsidiaries in the United States and/or other countries. onsemi reserves the right to make changes without further notice to any products herein. onsemi makes no warranty, representation or guarantee regarding the suitability of its products for any particular purpose, nor does onsemi assume any liability arising out of the application or use of any product or circuit, and specifically disclaims any and all liability, including without limitation special, consequential or incidental damages. onsemi does not convey any license under its patent rights nor the rights of others.

onsemi, **Onsemi**, and other names, marks, and brands are registered and/or common law trademarks of Semiconductor Components Industries, LLC dba "**onsemi**" or its affiliates and/or subsidiaries in the United States and/or other countries. **onsemi** owns the rights to a number of patents, trademarks, copyrights, trade secrets, and other intellectual property. A listing of **onsemi**'s product/patent coverage may be accessed at www.onsemi.com/site/pdf/Patent-Marking.pdf. **onsemi** reserves the right to make changes at any time to any products or information herein, without notice. The information herein is provided "as-is" and **onsemi** makes no warranty, representation or guarantee regarding the accuracy of the information, product features, availability, functionality, or suitability of its products for any particular purpose, nor does **onsemi** assume any liability arising out of the application or use of any product or circuit, and specifically disclaims any and all liability, including without limitation special, consequential or incidental damages. Buyer is responsible for its products and applications using **onsemi** products, including compliance with all laws, regulations and safety requirements or standards, regardless of any support or applications information provided by **onsemi**. "Typical" parameters which may be provided in **onsemi** data sheets and/or specifications can and do vary in different applications and actual performance may vary over time. All operating parameters, including "Typicals" must be validated for each customer application by customer's technical experts. **onsemi** does not convey any license under any of its intellectual property rights nor the rights of others. **onsemi** products are not designed, intended, or authorized for use as a critical component in life support systems or any FDA Class 3 medical devices or medical devices with a same or similar classification in a foreign jurisdiction or any devices intended for implantation in the human body. Should Buyer purchase or use **onsemi** products for any such unintended or unauthorized application, Buyer shall indemnify and hold **onsemi** and its officers, employees, subsidiaries, affiliates, and distributors harmless against all claims, costs, damages, and expenses, and reasonable attorney fees arising out of, directly or indirectly, any claim of personal injury or death associated with such unintended or unauthorized use, even if such claim alleges that **onsemi** was negligent regarding the design or manufacture of the part. **onsemi** is an Equal Opportunity/Affirmative Action Employer. This literature is subject to all applicable copyright laws and is not for resale in any manner.

ADDITIONAL INFORMATION

TECHNICAL PUBLICATIONS:

Technical Library: www.onsemi.com/design/resources/technical-documentation
onsemi Website: www.onsemi.com

ONLINE SUPPORT: www.onsemi.com/support

For additional information, please contact your local Sales Representative at www.onsemi.com/support/sales

