

MOSFET – Single N-Channel, POWERTRENCH®

40 V, 10 A, 14 mΩ

FDMA8051L

General Description

This device has been designed to provide maximum efficiency and thermal performance for synchronous buck converters. The low $r_{DS(on)}$ and gate charge provide excellent switching performance.

Features

- Max $r_{DS(on)}$ = 14 mΩ at $V_{GS} = 10\text{ V}$, $I_D = 10\text{ A}$
- Max $r_{DS(on)}$ = 18 mΩ at $V_{GS} = 4.5\text{ V}$, $I_D = 8.5\text{ A}$
- Low Profile – 0.8 mm maximum in the new package MicroFET 2 x 2 mm
- Free from halogenated compounds and antimony oxides
- RoHS Compliant

Application

- DC–DC Buck Converters

MOSFET MAXIMUM RATINGS ($T_A = 25^\circ\text{C}$ unless otherwise noted)

Symbol	Parameter	Ratings	Unit
V_{DS}	Drain to Source Voltage	40	V
V_{GS}	Gate to Source Voltage	± 20	V
I_D	Drain Current – Continuous $T_A = 25^\circ\text{C}$ (Note 1a)	10	A
	– Pulsed (Note 3)	80	
P_D	Power dissipation $T_A = 25^\circ\text{C}$ (Note 1a)	2.4	W
	Power dissipation $T_A = 25^\circ\text{C}$ (Note 1b)	0.9	
T_J , T_{STG}	Operating and Storage Junction Temperature Range	-55 to +150	$^\circ\text{C}$

Stresses exceeding those listed in the Maximum Ratings table may damage the device. If any of these limits are exceeded, device functionality should not be assumed, damage may occur and reliability may be affected.

THERMAL CHARACTERISTICS

Symbol	Parameter	Ratings	Unit
$R_{\theta JA}$	Thermal Resistance, Junction to Ambient (Note 1a)	52	$^\circ\text{C}/\text{W}$
$R_{\theta JA}$	Thermal Resistance, Junction to Ambient (Note 1b)	145	

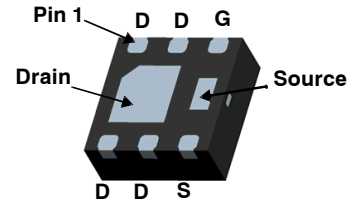

MicroFET 2x2
(WDFN6 2x2, 0.65P)
CASE 511DB

ELECTRICAL CONNECTION

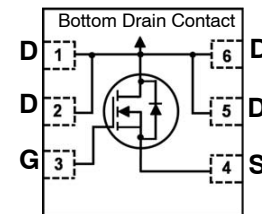

Single N-Channel MOSFET

MARKING DIAGRAM

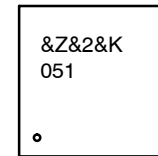

- &Z = Assembly Plant Code
- &2 = Numeric Date Code
- &K = Lot Code
- 051 = Specific Device Code

ORDERING INFORMATION

See detailed ordering and shipping information on page 2 of this data sheet.

FDMA8051L

PACKAGE MARKING AND ORDERING INFORMATION

Device Marking	Device	Package	Shipping [†]
051	FDMA8051L	MicroFET 2x2	3000 Units/ Tape & Reel

[†]For information on tape and reel specifications, including part orientation and tape sizes, please refer to our Tape and Reel Packaging Specifications Brochure, BRD8011/D.

ELECTRICAL CHARACTERISTICS (T_J = 25°C unless otherwise noted)

Symbol	Parameter	Test Condition	Min	Typ	Max	Unit
--------	-----------	----------------	-----	-----	-----	------

OFF CHARACTERISTICS

BV _{DSS}	Drain to Source Breakdown Voltage	I _D = 250 μA, V _{GS} = 0 V	40			V
$\frac{\Delta BV_{DSS}}{\Delta T_J}$	Breakdown Voltage Temperature Coefficient	I _D = 250 μA, referenced to 25°C		22		mV/°C
I _{DSS}	Zero Gate Voltage Drain Current	V _{DS} = 32 V, V _{GS} = 0 V			1	μA
I _{GSS}	Gate-to-Source Leakage Current	V _{GS} = ±20 V, V _{DS} = 0 V			100	nA

ON CHARACTERISTICS

V _{GS(th)}	Gate to Source Threshold Voltage	V _{GS} = V _{DS} , I _D = 250 μA	1.0	1.6	3.0	V
$\frac{\Delta V_{GS(th)}}{\Delta T_J}$	Gate to Source Threshold Voltage Temperature Coefficient	I _D = 250 μA, referenced to 25°C		-5		mV/°C
r _{DS(on)}	Static Drain to Source On Resistance	V _{GS} = 10 V, I _D = 10 A		11	14	mΩ
		V _{GS} = 4.5 V, I _D = 8.5 A		14	18	
		V _{GS} = 10 V, I _D = 10 A, T _J = 125°C		15	19	
g _{FS}	Forward Transconductance	V _{DD} = 5 V, I _D = 10 A		35		S

DYNAMIC CHARACTERISTICS

C _{iss}	Input Capacitance	V _{DS} = 20 V, V _{GS} = 0 V, f = 1 MHz		901	1260	pF
C _{oss}	Output Capacitance			251	350	
C _{rss}	Reverse Transfer Capacitance			16	25	
R _g	Gate Resistance	f = 1 MHz	0.1	0.6	1.8	Ω

SWITCHING CHARACTERISTICS

t _{d(on)}	Turn – On Delay Time	V _{DD} = 20 V, I _D = 10 A, V _{GS} = 10 V, R _{GEN} = 6 Ω		6.4	13	ns
t _r	Rise Time			1.8	10	
t _{D(off)}	Turn – Off Delay Time			17	31	
t _f	Fall Time			1.8	10	
Q _g	Total Gate Charge	V _{GS} = 0V to 10 V V _{GS} = 0V to 4.5 V V _{DD} = 20 V, i _D = 10 A		14	20	nC
Q _g	Total Gate Charge			6.4	9.0	
Q _{gs}	Total Gate Charge			2.4	3.7	
Q _{gd}	Gate to Source Charge			1.8	2.5	

DRAIN-SOURCE DIODE CHARACTERISTICS

V _{SD}	Source to Drain Diode Forward Voltage	V _{GS} = 0 V, I _S = 2 A (Note 2)		0.7	1.2	V
		V _{GS} = 0 V, I _S = 10 A (Note 2)		0.8	1.2	
t _{rr}	Reverse Recovery Time	I _F = 10 A, di/dt = 100 A/μs		23	37	ns
Q _{rr}	Reverse Recovery Charge			6.7	14	nC

Product parametric performance is indicated in the Electrical Characteristics for the listed test conditions, unless otherwise noted. Product performance may not be indicated by the Electrical Characteristics if operated under different conditions.

NOTES:

1. $R_{\theta JA}$ is determined with the device mounted on a 1 in² pad 2 oz copper pad on a 1.5 × 1.5 in. board of FR-4 material. $R_{\theta JC}$ is guaranteed by design while $R_{\theta JA}$ is determined by the user's board design.

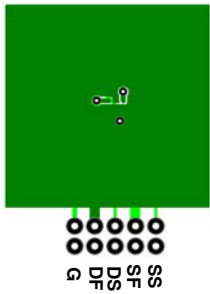

a) 52°C/W when mounted on a 1 in² pad of 2 oz copper.



b) 145°C/W when mounted on a minimum pad of 2 oz copper.

2. Pulse Test: Pulse Width < 300 μs, Duty cycle < 2.0%.
3. Pulsed I_D limited by junction temperature, $t_{d} \leq 100 \mu s$, please refer to SOA curve for more details.

TYPICAL CHARACTERISTICS $T_J = 25^\circ C$ unless otherwise noted

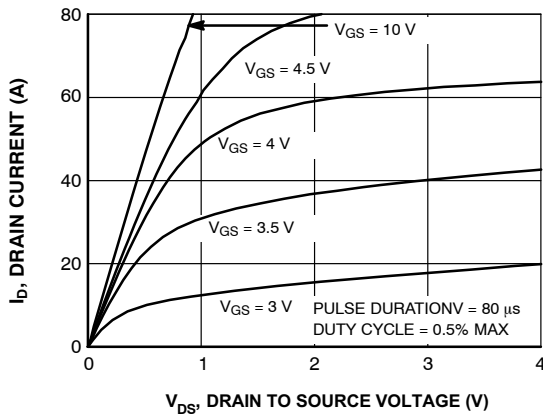

Figure 1. On Region Characteristics

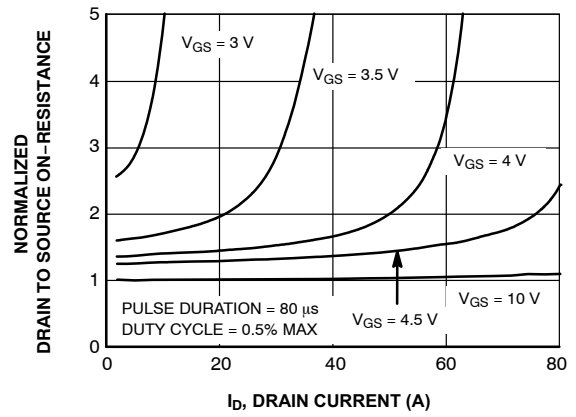

Figure 2. Normalized On-Resistance vs. Drain Current and Gate Voltage

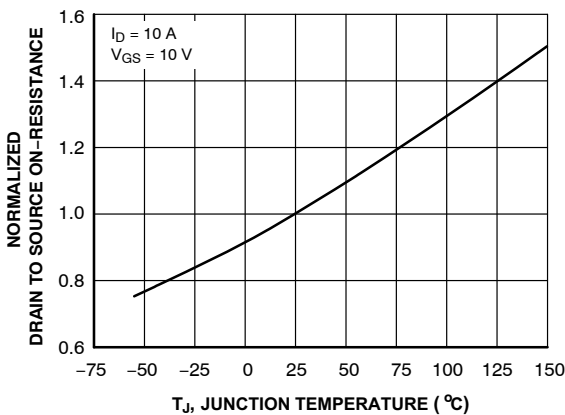

Figure 3. Normalized On Resistance vs. Junction Temperature

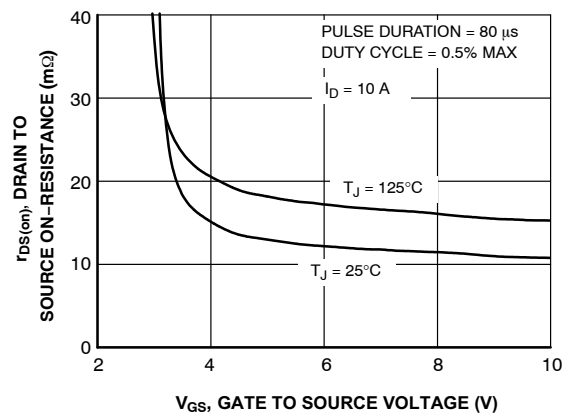

Figure 4. On-Resistance vs. Gate to Source Voltage

TYPICAL CHARACTERISTICS $T_J = 25^\circ\text{C}$ unless otherwise noted (continued)

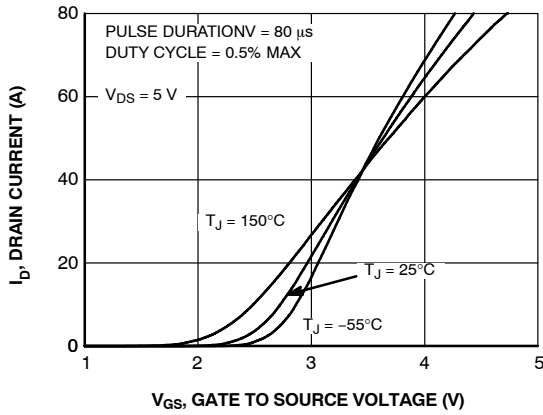

Figure 5. Transfer Characteristics

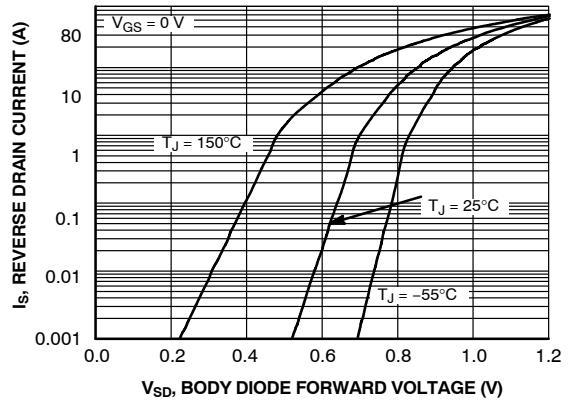

Figure 6. Source to Drain Diode Forward Voltage vs. Source Current

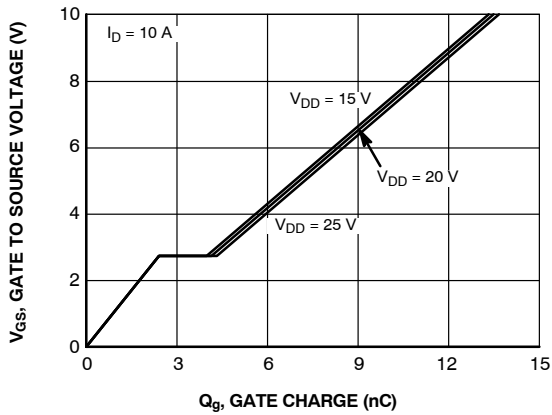

Figure 7. Gate Charge Characteristics

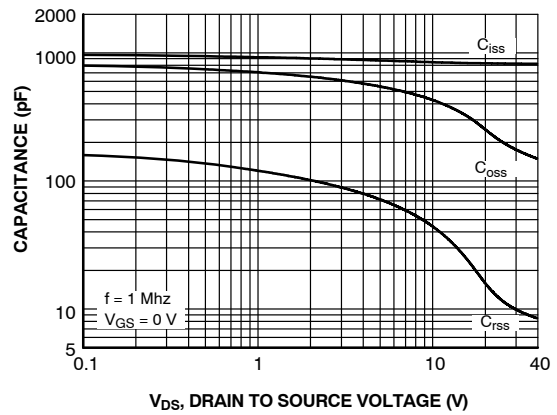

Figure 8. Capacitance vs. Drain to Source Voltage

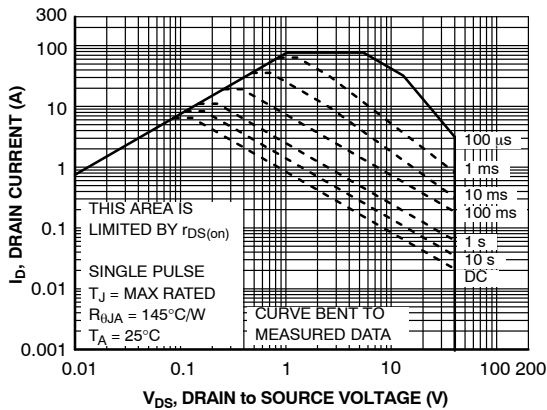

Figure 9. Forward Bias Safe Operating Area

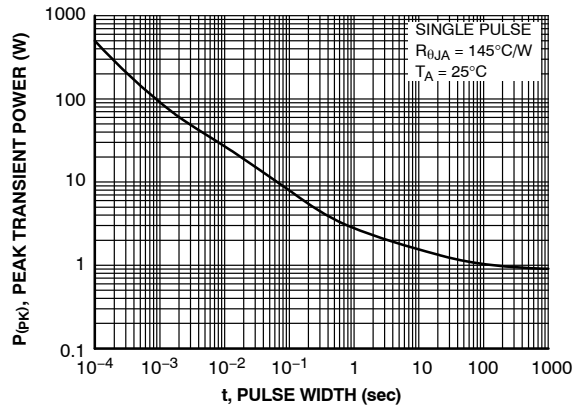

Figure 10. Single Pulse Maximum Power Dissipation

TYPICAL CHARACTERISTICS $T_J = 25^\circ\text{C}$ unless otherwise noted (continued)

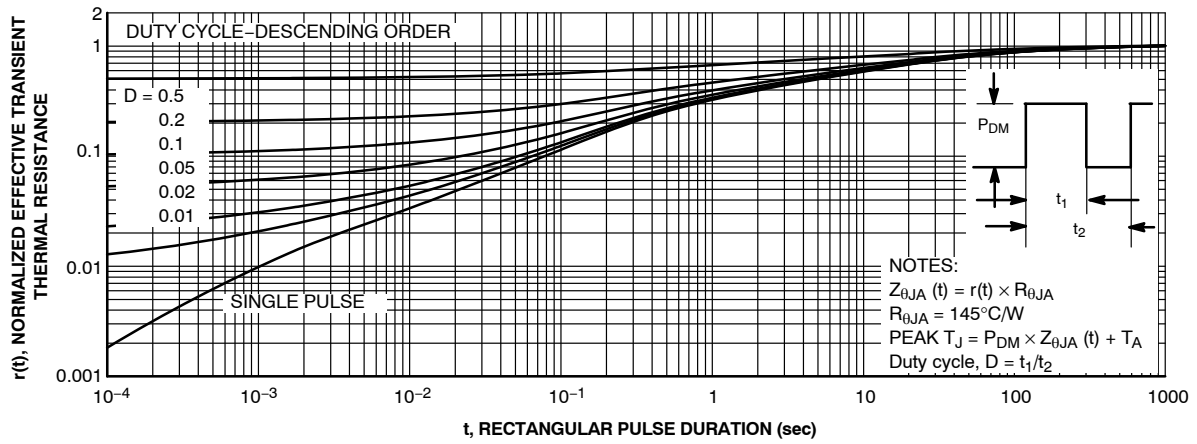

Figure 11. Single Pulse Junction-to-Ambient Transient Thermal Response Curve

MECHANICAL CASE OUTLINE

PACKAGE DIMENSIONS

ON Semiconductor®



WDFN6 2x2, 0.65P
CASE 511DB
ISSUE O

DATE 31 AUG 2016

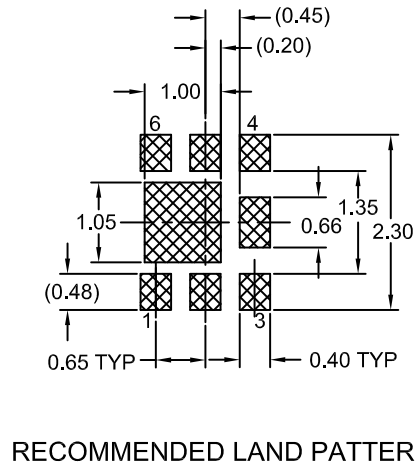
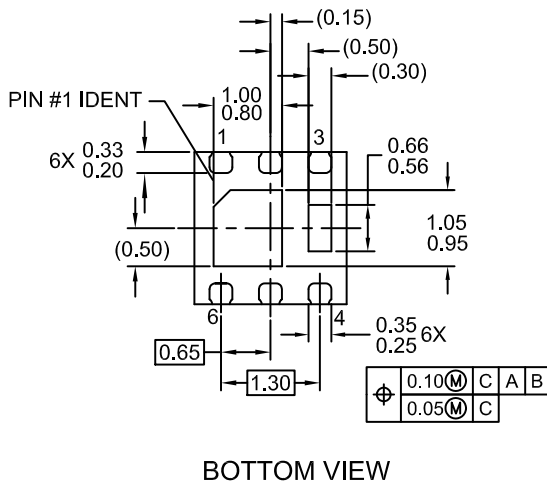
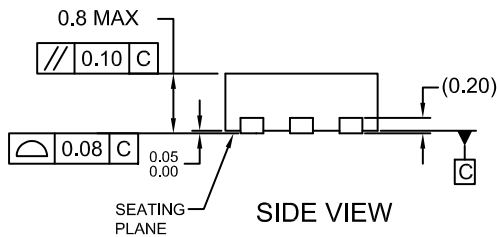
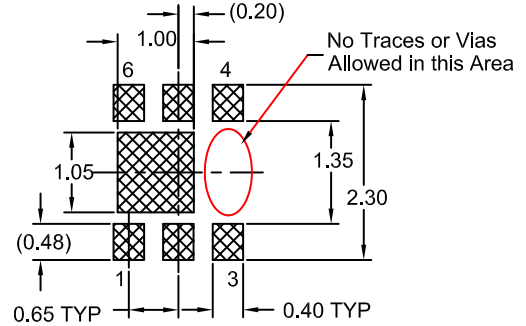
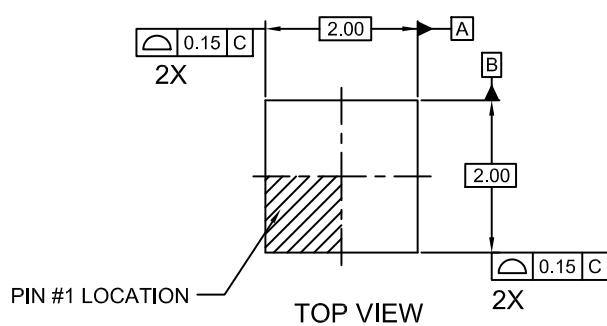

NOTES:

- A. DOES NOT FULLY CONFORM TO JEDEC REGISTRATION MO-229 DATED AUG/2003
- B. DIMENSIONS ARE IN MILLIMETERS.
- C. DIMENSIONS AND TOLERANCES PER ASME Y14.5M, 1994

DOCUMENT NUMBER:	98AON13617G	Electronic versions are uncontrolled except when accessed directly from the Document Repository. Printed versions are uncontrolled except when stamped "CONTROLLED COPY" in red.
DESCRIPTION:	WDFN6 2X2, 0.65P	PAGE 1 OF 1

ON Semiconductor and are trademarks of Semiconductor Components Industries, LLC dba ON Semiconductor or its subsidiaries in the United States and/or other countries. ON Semiconductor reserves the right to make changes without further notice to any products herein. ON Semiconductor makes no warranty, representation or guarantee regarding the suitability of its products for any particular purpose, nor does ON Semiconductor assume any liability arising out of the application or use of any product or circuit, and specifically disclaims any and all liability, including without limitation special, consequential or incidental damages. ON Semiconductor does not convey any license under its patent rights nor the rights of others.

onsemi, **Onsemi**, and other names, marks, and brands are registered and/or common law trademarks of Semiconductor Components Industries, LLC dba "**onsemi**" or its affiliates and/or subsidiaries in the United States and/or other countries. **onsemi** owns the rights to a number of patents, trademarks, copyrights, trade secrets, and other intellectual property. A listing of **onsemi**'s product/patent coverage may be accessed at www.onsemi.com/site/pdf/Patent-Marking.pdf. **onsemi** reserves the right to make changes at any time to any products or information herein, without notice. The information herein is provided "as-is" and **onsemi** makes no warranty, representation or guarantee regarding the accuracy of the information, product features, availability, functionality, or suitability of its products for any particular purpose, nor does **onsemi** assume any liability arising out of the application or use of any product or circuit, and specifically disclaims any and all liability, including without limitation special, consequential or incidental damages. Buyer is responsible for its products and applications using **onsemi** products, including compliance with all laws, regulations and safety requirements or standards, regardless of any support or applications information provided by **onsemi**. "Typical" parameters which may be provided in **onsemi** data sheets and/or specifications can and do vary in different applications and actual performance may vary over time. All operating parameters, including "Typicals" must be validated for each customer application by customer's technical experts. **onsemi** does not convey any license under any of its intellectual property rights nor the rights of others. **onsemi** products are not designed, intended, or authorized for use as a critical component in life support systems or any FDA Class 3 medical devices or medical devices with a same or similar classification in a foreign jurisdiction or any devices intended for implantation in the human body. Should Buyer purchase or use **onsemi** products for any such unintended or unauthorized application, Buyer shall indemnify and hold **onsemi** and its officers, employees, subsidiaries, affiliates, and distributors harmless against all claims, costs, damages, and expenses, and reasonable attorney fees arising out of, directly or indirectly, any claim of personal injury or death associated with such unintended or unauthorized use, even if such claim alleges that **onsemi** was negligent regarding the design or manufacture of the part. **onsemi** is an Equal Opportunity/Affirmative Action Employer. This literature is subject to all applicable copyright laws and is not for resale in any manner.

ADDITIONAL INFORMATION

TECHNICAL PUBLICATIONS:

Technical Library: www.onsemi.com/design/resources/technical-documentation
onsemi Website: www.onsemi.com

ONLINE SUPPORT: www.onsemi.com/support

For additional information, please contact your local Sales Representative at www.onsemi.com/support/sales