

MOSFET – N-Channel, Shielded Gate, POWERTRENCH®

100 V, 16 A, 56 mΩ

FDMC8622

General Description

This N-Channel MOSFET is produced using **onsemi**'s advanced POWERTRENCH process that incorporates Shielded Gate technology. This process has been optimized for $r_{DS(on)}$, switching performance and ruggedness.

Features

- Shielded Gate MOSFET Technology
- Max $r_{DS(on)}$ = 56 mΩ at $V_{GS} = 10$ V, $I_D = 4$ A
- Max $r_{DS(on)}$ = 90 mΩ at $V_{GS} = 6$ V, $I_D = 3$ A
- High Performance Trench Technology for Extremely Low $r_{DS(on)}$
- High Power and Current Handling Capability in a Widely Used Surface Mount Package
- 100% UIL Tested
- This Device is Pb-Free and is ROHS Compliant

V_{DS}	$r_{DS(on)}$ MAX	I_D MAX
100 V	56 mΩ @ 10 V	16 A
	90 mΩ @ 6 V	

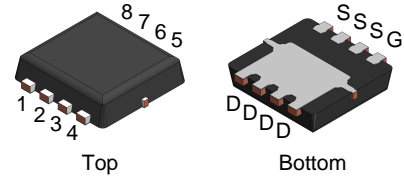

WDFN8 3.3x3.3, 0.65P
 (MLP 3.3x3.3)
 CASE 511DR

MARKING DIAGRAM

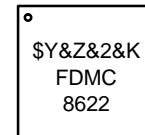

- \$Y = Logo
- &Z = Assembly Plant Code
- &2 = 2-Digit Date Code Format
- &K = 2-Digits Lot Run Traceability Code
- FDMC8622 = Device Code

PIN ASSIGNMENT

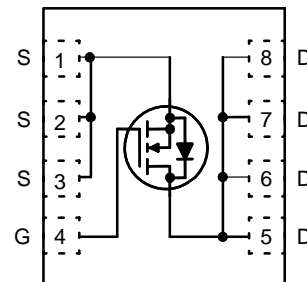

ORDERING INFORMATION

See detailed ordering and shipping information on page 6 of this data sheet.

FDMC8622

MOSFET MAXIMUM RATINGS ($T_A = 25^\circ\text{C}$ unless otherwise noted)

Symbol	Parameter	Ratings	Unit		
V_{DS}	Drain to Source Voltage	100	V		
V_{GS}	Gate to Source Voltage	± 20	V		
I_D	Drain Current	Continuous	$T_C = 25^\circ\text{C}$	A	
		Continuous (Note 3a)	$T_A = 25^\circ\text{C}$		4
		Pulsed (Note 2)			30
E_{AS}	Single Pulse Avalanche Energy (Note 1)	37	mJ		
P_D	Power Dissipation	$T_C = 25^\circ\text{C}$	31	W	
	Power Dissipation (Note 3a)	$T_A = 25^\circ\text{C}$	2.3		
T_J, T_{STG}	Operating and Storage Junction Temperature Range	-55 to +150	$^\circ\text{C}$		

Stresses exceeding those listed in the Maximum Ratings table may damage the device. If any of these limits are exceeded, device functionality should not be assumed, damage may occur and reliability may be affected.

- Starting $T_J = 25^\circ\text{C}$; N-ch: $L = 3.0\text{ mH}$, $I_{AS} = 5.0\text{ A}$, $V_{DD} = 100\text{ V}$, $V_{GS} = 10\text{ V}$.
- Pulse I_D refers to Figure 11. Forward Bias Safe Operation Area.

THERMAL CHARACTERISTICS

Symbol	Parameter	Ratings	Unit
$R_{\theta JC}$	Thermal Resistance, Junction to Case (Note 3)	4.0	$^\circ\text{C/W}$
$R_{\theta JA}$	Thermal Resistance, Junction to Ambient (Note 3a)	53	

- $R_{\theta JA}$ is determined with the device mounted on a 1 in^2 pad 2 oz copper pad on a $1.5 \times 1.5\text{ in.}$ board of FR-4 material. $R_{\theta JC}$ is guaranteed by design while $R_{\theta CA}$ is determined by the user's board design.

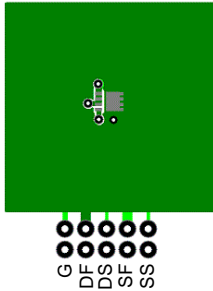

a. 53°C/W when mounted on a 1 in^2 pad of 2 oz copper



b. 125°C/W when mounted on a minimum pad of 2 oz copper

FDMC8622

ELECTRICAL CHARACTERISTICS (T_J = 25°C unless otherwise noted)

Symbol	Parameter	Test Conditions	Min	Typ	Max	Unit
--------	-----------	-----------------	-----	-----	-----	------

OFF CHARACTERISTICS

BV _{DSS}	Drain to Source Breakdown Voltage	I _D = 250 μA, V _{GS} = 0 V	100	–	–	V
$\frac{\Delta BV_{DSS}}{\Delta T_J}$	Breakdown Voltage Temperature Coefficient	I _D = 250 μA, referenced to 25°C	–	69	–	mV/°C
I _{DSS}	Zero Gate Voltage Drain Current	V _{DS} = 80 V, V _{GS} = 0 V	–	–	1	μA
I _{GSS}	Gate to Source Leakage Current	V _{GS} = ±20 V, V _{DS} = 0 V	–	–	±100	nA

ON CHARACTERISTICS

V _{GS(th)}	Gate to Source Threshold Voltage	V _{GS} = V _{DS} , I _D = 250 μA	2	2.9	4	V
$\frac{\Delta V_{GS(th)}}{\Delta T_J}$	Gate to Source Threshold Voltage Temperature Coefficient	I _D = 250 μA, referenced to 25°C	–	–9	–	mV/°C
r _{DS(on)}	Static Drain to Source On Resistance	V _{GS} = 10 V, I _D = 4 A	–	43.7	56	mΩ
		V _{GS} = 6 V, I _D = 3 A	–	59.9	90	
		V _{GS} = 10 V, I _D = 4 A, T _J = 125°C	–	76.4	98	
g _{FS}	Forward Transconductance	V _{DS} = 10 V, I _D = 4 A	–	8.9	–	S

DYNAMIC CHARACTERISTICS

C _{iss}	Input Capacitance	V _{DS} = 50 V, V _{GS} = 0 V, f = 1 MHz	–	302	402	pF
C _{oss}	Output Capacitance		–	72.5	96	pF
C _{rss}	Reverse Transfer Capacitance		–	4.2	6	pF
R _g	Gate Resistance		–	1.0	–	Ω

SWITCHING CHARACTERISTICS

t _{d(on)}	Turn-On Delay Time	V _{DD} = 50 V, I _D = 4 A, V _{GS} = 10 V, R _{GEN} = 6 Ω	–	5.9	12	ns
t _r	Rise Time		–	1.6	10	ns
t _{d(off)}	Turn-Off Delay Time		–	10.2	18	ns
t _f	Fall Time		–	2.2	10	ns
Q _{g(TOT)}	Total Gate Charge	V _{GS} = 0 V to 10 V, V _{DD} = 50 V, I _D = 4 A	–	5.2	7.3	nC
Q _{g(TOT)}	Total Gate Charge	V _{GS} = 0 V to 5 V, V _{DD} = 50 V, I _D = 4 A	–	3.0	4.1	nC
Q _{gs}	Total Gate Charge	V _{DD} = 50 V, I _D = 4 A	–	1.4	–	nC
Q _{gd}	Gate to Drain "Miller" Charge		–	1.4	–	nC

DRAIN-SOURCE DIODE CHARACTERISTICS

V _{SD}	Source to Drain Diode Forward Voltage	V _{GS} = 0 V, I _S = 4 A (Note 4)	–	0.8	1.3	V
		V _{GS} = 0 V, I _S = 1.7 A (Note 4)	–	0.8	1.2	
t _{rr}	Reverse Recovery Time	I _F = 4 A, di/dt = 100 A/μs	–	36	57	ns
Q _{rr}	Reverse Recovery Charge		–	28	45	nC

Product parametric performance is indicated in the Electrical Characteristics for the listed test conditions, unless otherwise noted. Product performance may not be indicated by the Electrical Characteristics if operated under different conditions.

4. Pulse Test: Pulse Width < 300 μs, Duty cycle < 2.0%.

TYPICAL CHARACTERISTICS ($T_J = 25^\circ\text{C}$ unless otherwise noted)

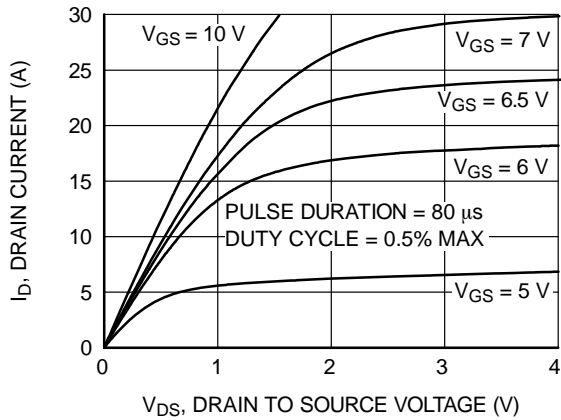

Figure 1. On Region Characteristics

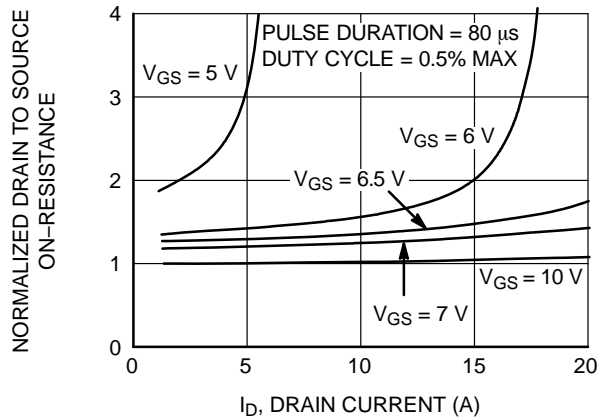

Figure 2. Normalized On-Resistance vs. Drain Current and Gate Voltage

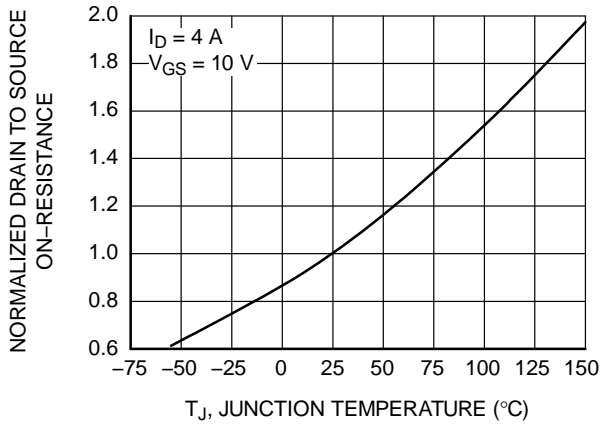

Figure 3. Normalized On-Resistance vs. Junction Temperature

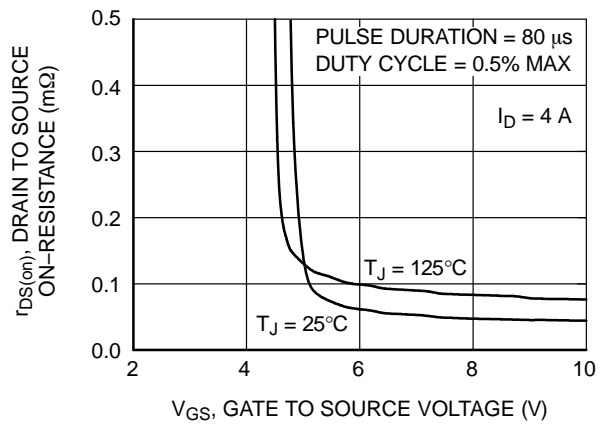

Figure 4. On-Resistance vs. Gate to Source Voltage

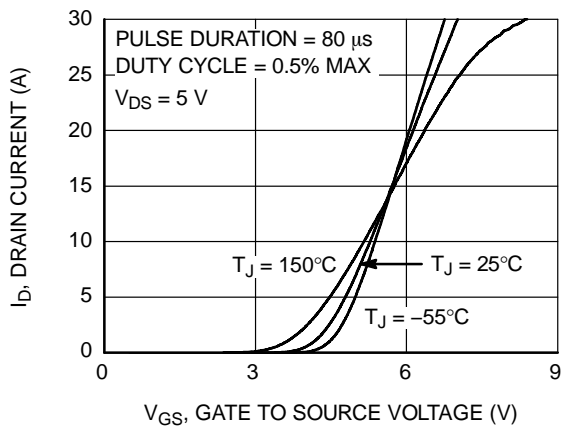

Figure 5. Transfer Characteristics

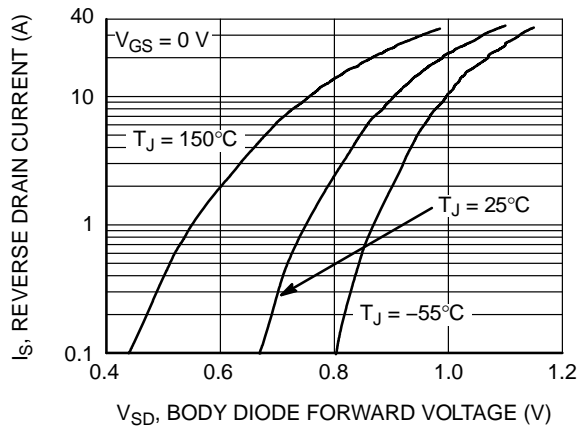

Figure 6. Source to Drain Diode Forward Voltage vs. Source Current

TYPICAL CHARACTERISTICS ($T_J = 25^\circ\text{C}$ unless otherwise noted) (continued)

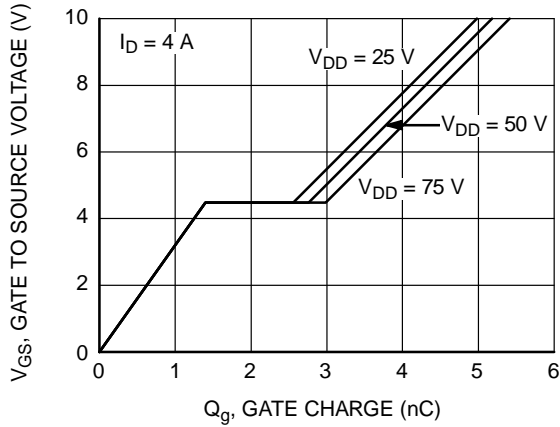

Figure 7. Gate Charge Characteristics

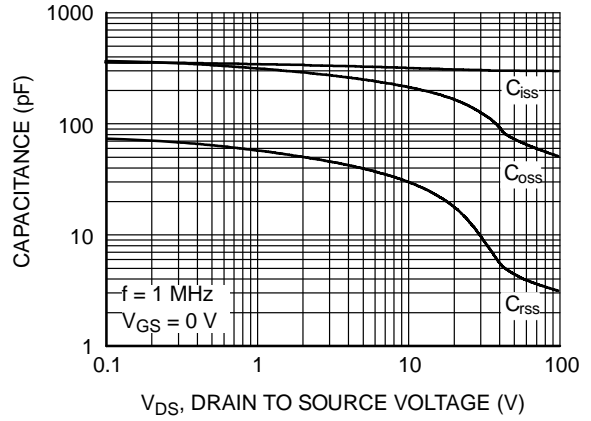

Figure 8. Capacitance vs. Drain to Source Voltage

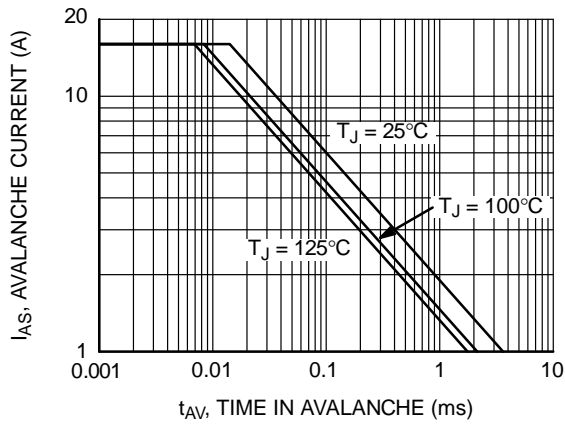

Figure 9. Unclamped Inductive Switching Capability

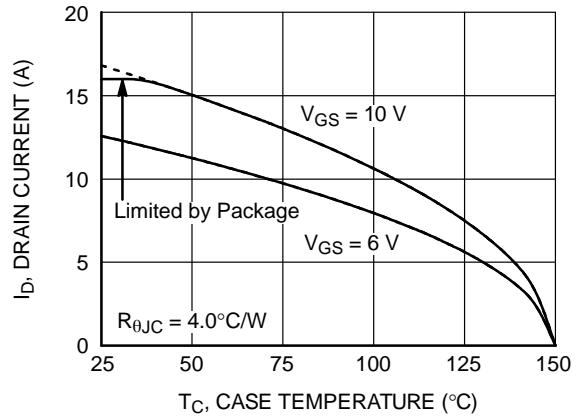

Figure 10. Maximum Continuous Drain Current vs. Case Temperature

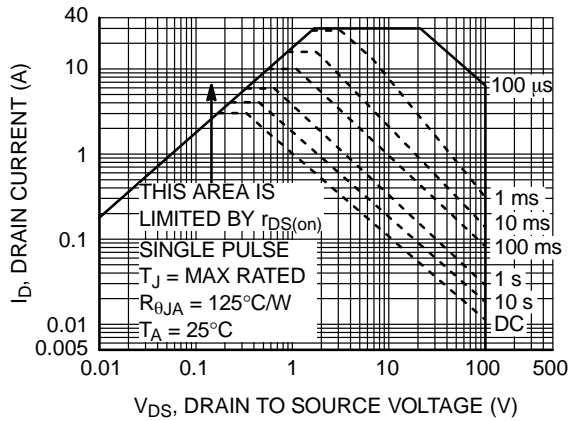

Figure 11. Forward Bias Safe Operating Area

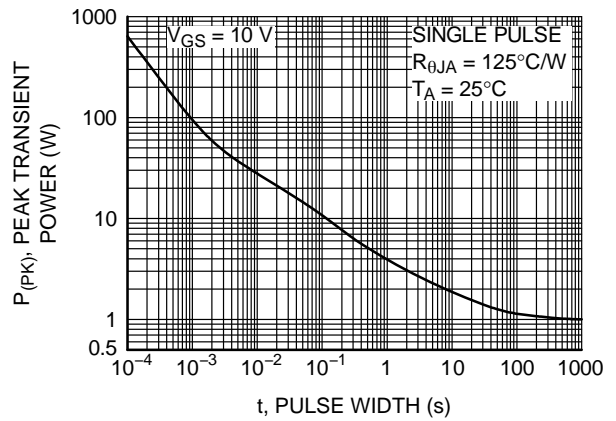

Figure 12. Single Pulse Maximum Power Dissipation

FDMC8622

TYPICAL CHARACTERISTICS ($T_J = 25^\circ\text{C}$ unless otherwise noted) (continued)

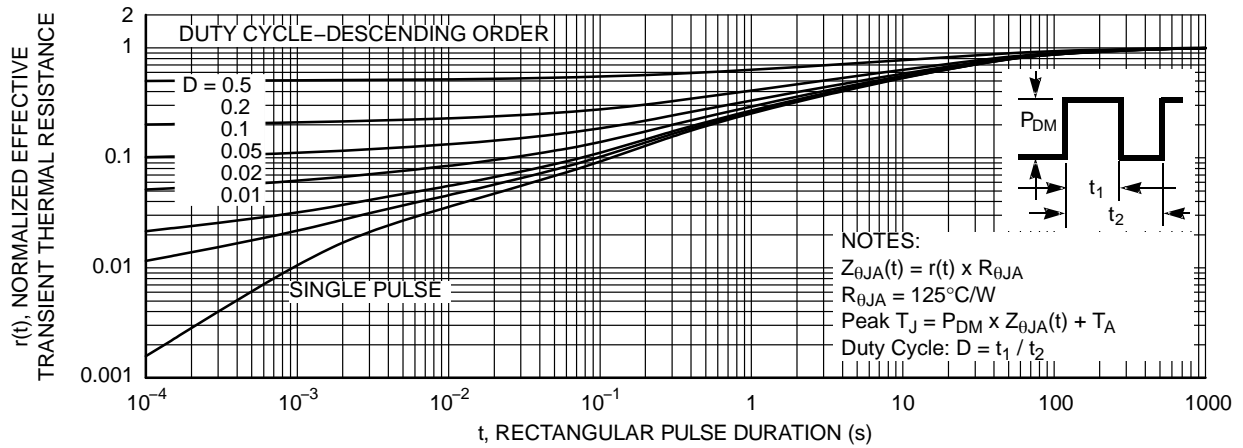

Figure 13. Junction-to-Ambient Transient Thermal Response Curve

PACKAGE MARKING AND ORDERING INFORMATION

Device	Device Marking	Package Type	Reel Size	Tape Width	Shipping [†]
FDMC8622	FDMC8622	WDFN8 3.3x3.3, 0.65P (MLP 3.3x3.3) (Pb-Free)	13"	12 mm	3000 / Tape & Reel

[†]For information on tape and reel specifications, including part orientation and tape sizes, please refer to our Tape and Reel Packaging Specifications Brochure, BRD8011/D.

MECHANICAL CASE OUTLINE PACKAGE DIMENSIONS

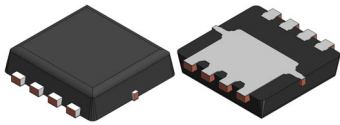

WDFN8 3.3x3.3, 0.65P
CASE 511DR
ISSUE B

DATE 02 FEB 2022

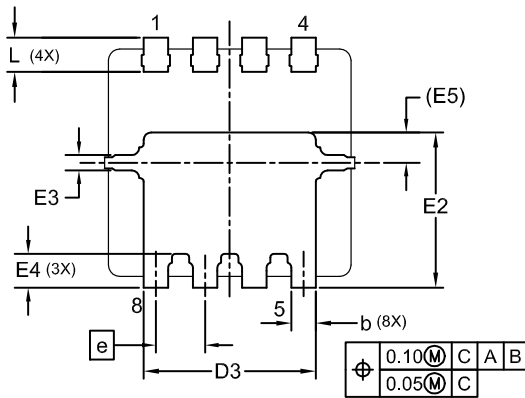
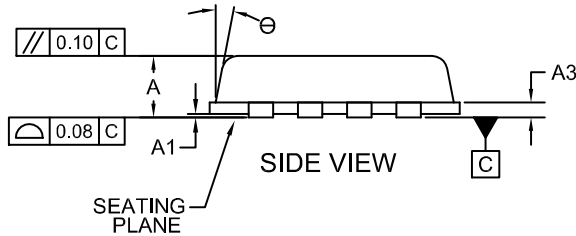
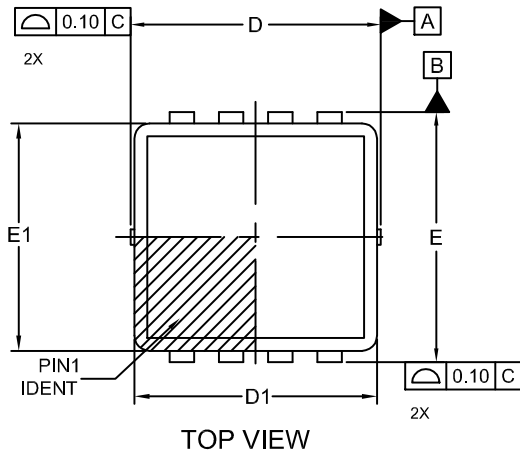

NOTES:

- A. DIMENSIONS AND TOLERANCES PER ASME Y14.5M, 2009.
- B. SEATING PLANE IS DEFINED BY TERMINAL TIPS ONLY
- C. BODY DIMENSIONS DO NOT INCLUDE MOLD FLASH PROTRUSIONS NOR GATE BURRS. MOLD FLASH PROTRUSION OR GATE BURR DOES NOT EXCEED 0.150MM.

DIM	MILLIMETERS		
	MIN	NOM	MAX
A	0.70	0.75	0.80
A1	0.00	-	0.05
A3	0.15	0.20	0.25
b	0.27	0.32	0.37
D	3.20	3.30	3.40
D1	3.10	3.20	3.30
D3	2.17	2.27	2.37
E	3.20	3.30	3.40
E1	2.90	3.00	3.10
E2	1.95	2.05	2.15
E3	0.15	0.20	0.25
E4	0.30	0.40	0.50
E5	0.40 REF		
e	0.65 BSC		
L	0.30	0.40	0.50
θ	0°	-	12°

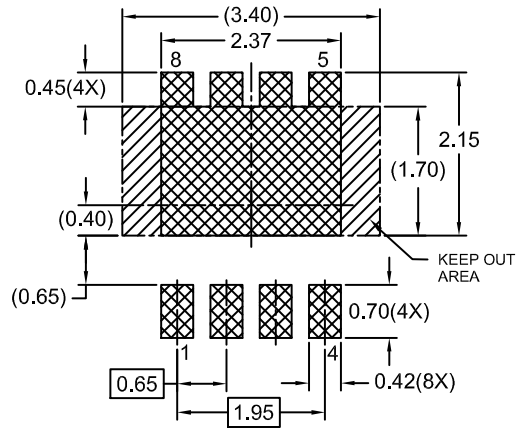

RECOMMENDED LAND PATTERN

*FOR ADDITIONAL INFORMATION ON OUR PB-FREE STRATEGY AND SOLDERING DETAILS, PLEASE DOWNLOAD THE ON SEMICONDUCTOR SOLDERING AND MOUNTING TECHNIQUES REFERENCE MANUAL, SOLDERRM/D.

GENERIC MARKING DIAGRAM*

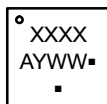

- XXXX = Specific Device Code
- A = Assembly Location
- Y = Year
- WW = Work Week
- = Pb-Free Package

*This information is generic. Please refer to device data sheet for actual part marking. Pb-Free indicator, "G" or microdot "▪", may or may not be present. Some products may not follow the Generic Marking.

(Note: Microdot may be in either location)

DOCUMENT NUMBER:	98AON13650G	Electronic versions are uncontrolled except when accessed directly from the Document Repository. Printed versions are uncontrolled except when stamped "CONTROLLED COPY" in red.
DESCRIPTION:	WDFN8 3.3x3.3, 0.65P	PAGE 1 OF 1

onsemi and ONSEMI are trademarks of Semiconductor Components Industries, LLC dba onsemi or its subsidiaries in the United States and/or other countries. onsemi reserves the right to make changes without further notice to any products herein. onsemi makes no warranty, representation or guarantee regarding the suitability of its products for any particular purpose, nor does onsemi assume any liability arising out of the application or use of any product or circuit, and specifically disclaims any and all liability, including without limitation special, consequential or incidental damages. onsemi does not convey any license under its patent rights nor the rights of others.

onsemi, **Onsemi**, and other names, marks, and brands are registered and/or common law trademarks of Semiconductor Components Industries, LLC dba "**onsemi**" or its affiliates and/or subsidiaries in the United States and/or other countries. **onsemi** owns the rights to a number of patents, trademarks, copyrights, trade secrets, and other intellectual property. A listing of **onsemi**'s product/patent coverage may be accessed at www.onsemi.com/site/pdf/Patent-Marking.pdf. **onsemi** reserves the right to make changes at any time to any products or information herein, without notice. The information herein is provided "as-is" and **onsemi** makes no warranty, representation or guarantee regarding the accuracy of the information, product features, availability, functionality, or suitability of its products for any particular purpose, nor does **onsemi** assume any liability arising out of the application or use of any product or circuit, and specifically disclaims any and all liability, including without limitation special, consequential or incidental damages. Buyer is responsible for its products and applications using **onsemi** products, including compliance with all laws, regulations and safety requirements or standards, regardless of any support or applications information provided by **onsemi**. "Typical" parameters which may be provided in **onsemi** data sheets and/or specifications can and do vary in different applications and actual performance may vary over time. All operating parameters, including "Typicals" must be validated for each customer application by customer's technical experts. **onsemi** does not convey any license under any of its intellectual property rights nor the rights of others. **onsemi** products are not designed, intended, or authorized for use as a critical component in life support systems or any FDA Class 3 medical devices or medical devices with a same or similar classification in a foreign jurisdiction or any devices intended for implantation in the human body. Should Buyer purchase or use **onsemi** products for any such unintended or unauthorized application, Buyer shall indemnify and hold **onsemi** and its officers, employees, subsidiaries, affiliates, and distributors harmless against all claims, costs, damages, and expenses, and reasonable attorney fees arising out of, directly or indirectly, any claim of personal injury or death associated with such unintended or unauthorized use, even if such claim alleges that **onsemi** was negligent regarding the design or manufacture of the part. **onsemi** is an Equal Opportunity/Affirmative Action Employer. This literature is subject to all applicable copyright laws and is not for resale in any manner.

ADDITIONAL INFORMATION

TECHNICAL PUBLICATIONS:

Technical Library: www.onsemi.com/design/resources/technical-documentation
onsemi Website: www.onsemi.com

ONLINE SUPPORT: www.onsemi.com/support

For additional information, please contact your local Sales Representative at www.onsemi.com/support/sales