

# MOSFET – N-Channel, POWERTRENCH<sup>®</sup>, GreenBridge™ Series of High-Efficiency Bridge Rectifiers

100 V, 6 A, 110 mΩ

## FDMQ8403

### General Description

This quad MOSFET solution provides ten-fold improvement in power dissipation over diode bridge.

### Features

- Max  $r_{DS(on)}$  = 110 mΩ at  $V_{GS} = 10$  V,  $I_D = 3$  A
- Max  $r_{DS(on)}$  = 175 mΩ at  $V_{GS} = 6$  V,  $I_D = 2.4$  A
- Substantial Efficiency Benefit in PD Solutions
- This Device is Pb-Free, Halid Free and is RoHS Compliant

### Applications

- High-Efficiency Bridge Rectifiers

### MOSFET MAXIMUM RATINGS ( $T_A = 25^\circ\text{C}$ unless otherwise noted)

Symbol	Rating	Value	Unit
$V_{DS}$	Drain to Source Voltage	100	V
$V_{GS}$	Gate to Source Voltage	±20	V
$I_D$	Drain Current – Continuous (Package Limited) $T_C = 25^\circ\text{C}$ – Continuous (Silicon Limited) $T_C = 25^\circ\text{C}$ – Continuous (Note 1a.) $T_A = 25^\circ\text{C}$ – Pulsed	6	A
		9	
		3.1	
		12	
$P_D$	Power Dissipation $T_C = 25^\circ\text{C}$	17	W
	Power Dissipation (Note 1a.) $T_A = 25^\circ\text{C}$	1.9	
$T_J, T_{STG}$	Operating and Storage Junction Temperature Range	–55 to +150	$^\circ\text{C}$

Stresses exceeding those listed in the Maximum Ratings table may damage the device. If any of these limits are exceeded, device functionality should not be assumed, damage may occur and reliability may be affected.

### THERMAL CHARACTERISTICS

Symbol	Rating	Value	Unit
$R_{\theta JA}$	Thermal Resistance, Junction to Ambient (Note 1a.)	65	$^\circ\text{C}/\text{W}$
$R_{\theta JA}$	Thermal Resistance, Junction to Ambient (Note 1b.)	135	

$V_{DSS}$	$R_{DS(ON)}$ MAX	$I_D$ MAX
100 V	110 $\Omega$ @ 10 V	6 A

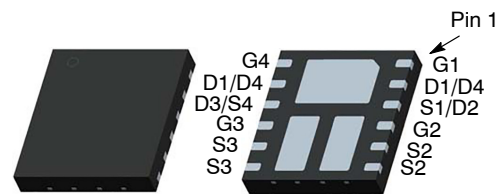

WDFN12 5 x 4.5, 0.8P  
(MLP 4.5 x 5)  
CASE 511CR

### MARKING DIAGRAM

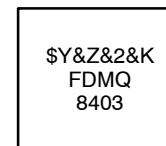

- FDMQ8403 = Specific Device Code  
 \$Y = onsemi Logo  
 &Z = Assembly plant code  
 &2 = Date Code format (Year and Week)  
 &K = Lot Run Traceability Code

### PIN CONNECTION

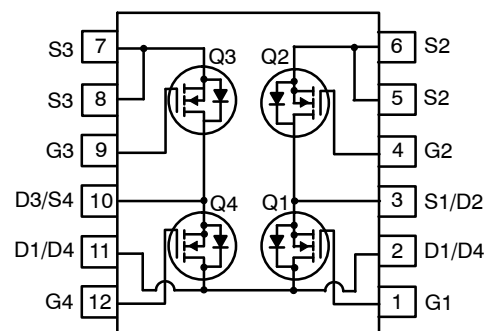

### ORDERING INFORMATION

See detailed ordering and shipping information on page 5 of this data sheet.

# FDMQ8403

## ELECTRICAL CHARACTERISTICS ( $T_J = 25^\circ\text{C}$ unless otherwise noted)

Symbol	Parameter	Test Condition	Min	Typ	Max	Unit
$BV_{DSS}$	Drain to Source Breakdown Voltage	$V_{GS} = 0\text{ V}, I_D = 250\ \mu\text{A}$	100	–	–	V
$\frac{\Delta BV_{DSS}}{\Delta T_J}$	Breakdown Voltage Temperature Coefficient	$I_D = 250\ \mu\text{A}$ , Referenced to $25^\circ\text{C}$	–	72	–	$\text{mV}/^\circ\text{C}$
$I_{DSS}$	Zero Gate Voltage Drain Current	$V_{GS} = 0\text{ V}, V_{DS} = 80\text{ V}$	–	–	1	nA
$I_{GSS}$	Gate to Source Leakage Current	$V_{GS} = \pm 20\text{ V}, V_{DS} = 0\text{ V}$	–	–	$\pm 100$	$\mu\text{A}$

## OFF CHARACTERISTICS

$V_{GS(th)}$	Drain to Source Breakdown Voltage	$V_{GS} = V_{DS}, I_D = 250\ \mu\text{A}$	2	2.8	4	V
$\frac{\Delta V_{GS(th)}}{\Delta T_J}$	Breakdown Voltage Temperature Coefficient	$I_D = 250\ \mu\text{A}$ , Referenced to $25^\circ\text{C}$	–	–8	–	$\text{mV}/^\circ\text{C}$
$r_{DS(on)}$	Static Drain to Source On Resistance	$V_{GS} = 10\text{ V}, I_D = 3\text{ A}$	–	85	110	$\text{m}\Omega$
		$V_{GS} = 6\text{ V}, I_D = 2.4\text{ A}$	–	115	175	
		$V_{GS} = 10\text{ V}, I_D = 3\text{ A}, T_J = 125^\circ\text{C}$	–	147	191	
$g_{FS}$	Forward Transconductance	$V_{DS} = 10\text{ V}, I_D = 3\text{ A}$	–	6	–	S

## DYNAMIC CHARACTERISTICS

$C_{iss}$	Input Capacitance	$V_{DS} = 50\text{ V}, V_{GS} = 0\text{ V}, f = 1\text{ MHz}$	–	162	215	pF
$C_{oss}$	Output Capacitance		–	43	60	pF
$C_{rss}$	Reverse Transfer Capacitance		–	2.6	5	pF

## DYNAMIC CHARACTERISTICS

$t_{d(on)}$	Turn-On Delay Time	$V_{DD} = 50\text{ V}, I_D = 3\text{ A},$ $V_{GS} = 10\text{ V}, R_{GEN} = 6\ \Omega$	–	4.1	10	ns	
$t_r$	Rise Time		–	1.2	10	ns	
$t_{d(off)}$	Turn-Off Delay Time		–	7.2	15	ns	
$t_f$	Fall Time		–	1.8	10	ns	
$Q_g$	Total Gate Charge	$V_{GS} = 0\text{ V to } 10\text{ V}$	$V_{DD} = 50\text{ V},$ $I_D = 3\text{ A}$	–	3	5	nC
$Q_g$	Total Gate Charge	$V_{GS} = 0\text{ V to } 5\text{ V}$		–	1.7	3	nC
$Q_{gs}$	Gate to Source Charge	$V_{DD} = 50\text{ V},$ $I_D = 3\text{ A}$	–	0.9	–	nC	
$Q_{gd}$	Gate to Drain "Miller" Charge	$V_{DD} = 50\text{ V},$ $I_D = 3\text{ A}$	–	0.8	–	nC	

## DRAIN-SOURCE DIODE CHARACTERISTICS

$V_{SD}$	Source to Drain Diode Forward Voltage	$V_{GS} = 0\text{ V}, I_S = 3\text{ A}$ (Note 2)	–	0.86	1.3	V
$t_{rr}$	Reverse Recovery Time	$I_F = 3\text{ A}, di/dt = 100\text{ A}/\mu\text{s}$	–	33	53	ns
$Q_{rr}$	Reverse Recovery Charge		–	23	37	nC

Product parametric performance is indicated in the Electrical Characteristics for the listed test conditions, unless otherwise noted. Product performance may not be indicated by the Electrical Characteristics if operated under different conditions.

- $R_{\theta JA}$  is determined with the device mounted on a  $1\text{ in}^2$  pad 2 oz copper pad on a  $1.5 \times 1.5\text{ in.}$  board of FR-4 material.  $R_{\theta JC}$  is guaranteed by design while  $R_{\theta CA}$  is determined by the user's board design.



a.  $65^\circ\text{C}/\text{W}$  when mounted on a  $1\text{ in}^2$  pad of 2 oz copper, the board designed Q1 + Q3 or Q2 + Q4.

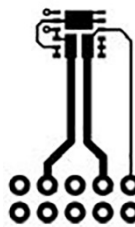

b.  $135^\circ\text{C}/\text{W}$  when mounted on a minimum pad of 2 oz copper, the board designed Q1 + Q3 or Q2 + Q4.

- Pulse Test: Pulse Width  $< 300\ \mu\text{s}$ , Duty cycle  $< 2.0\%$ .

TYPICAL CHARACTERISTICS ( $T_J = 25^\circ\text{C}$  unless otherwise noted.)

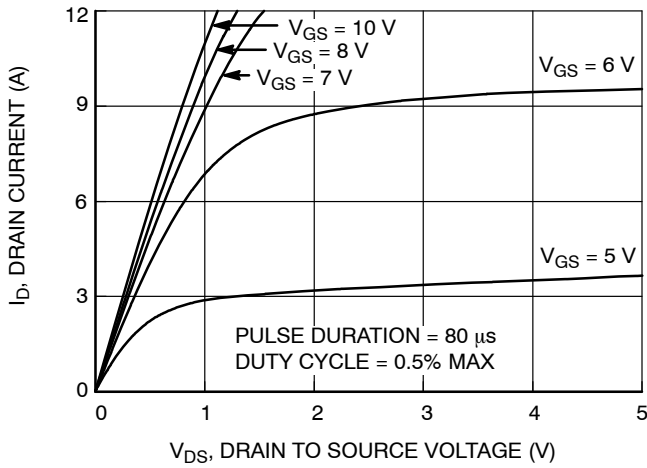

Figure 1. On Region Characteristics

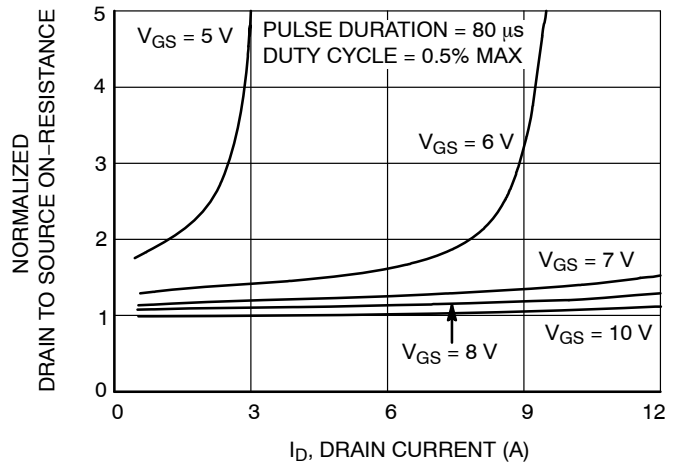

Figure 2. Normalized On-Resistance vs. Drain Current and Gate Voltage

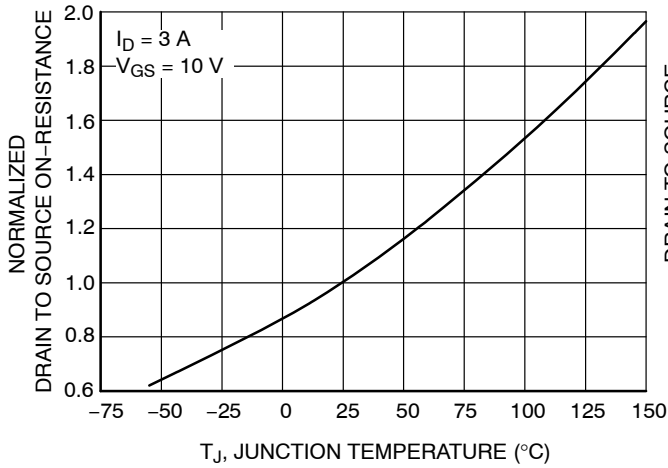

Figure 3. Normalized On Resistance vs. Junction Temperature

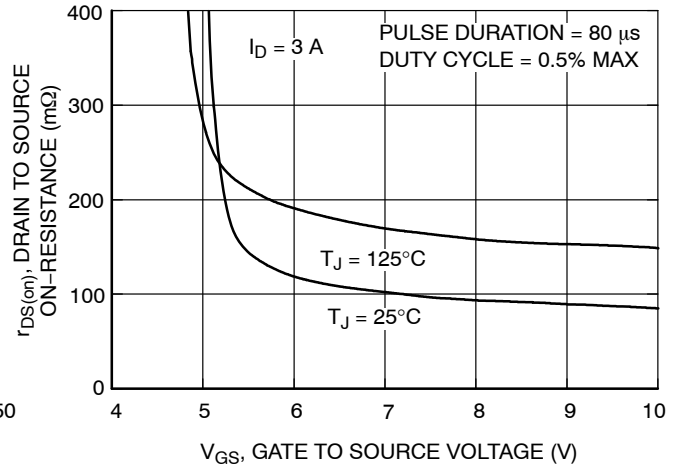

Figure 4. On-Resistance vs. Gate to Source Voltage

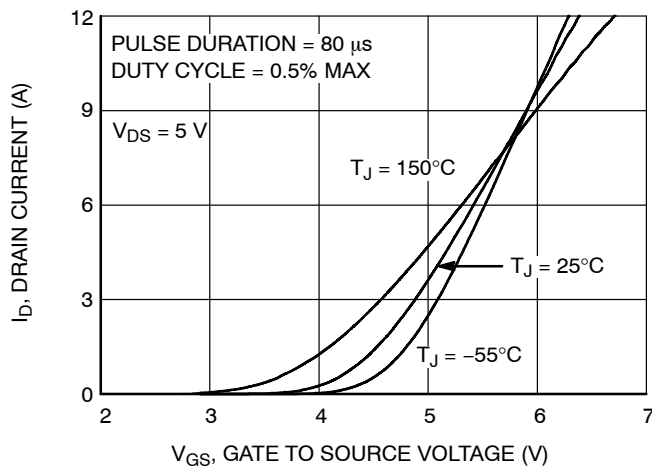

Figure 5. Transfer Characteristics

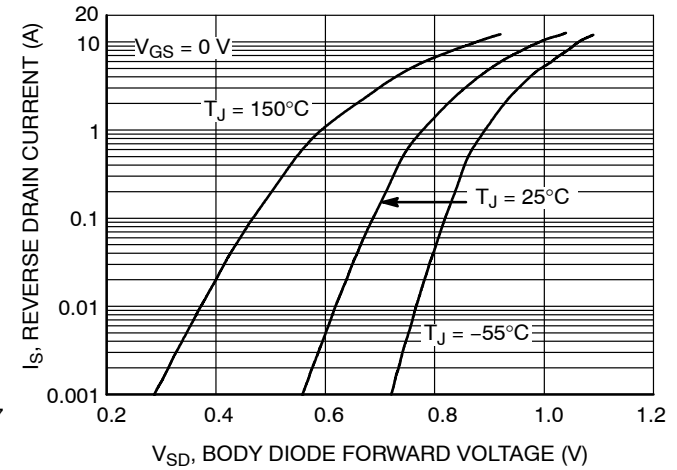

Figure 6. Source to Drain Diode Forward Voltage vs. Source Current

TYPICAL CHARACTERISTICS ( $T_J = 25^\circ\text{C}$  unless otherwise noted) (continued)

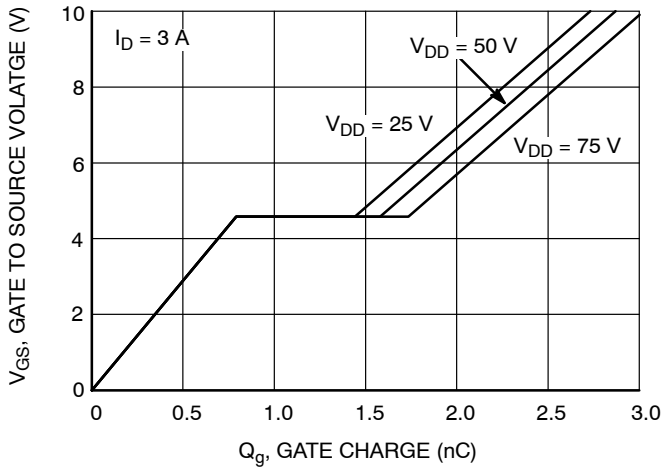

Figure 7. Gate Charge Characteristics

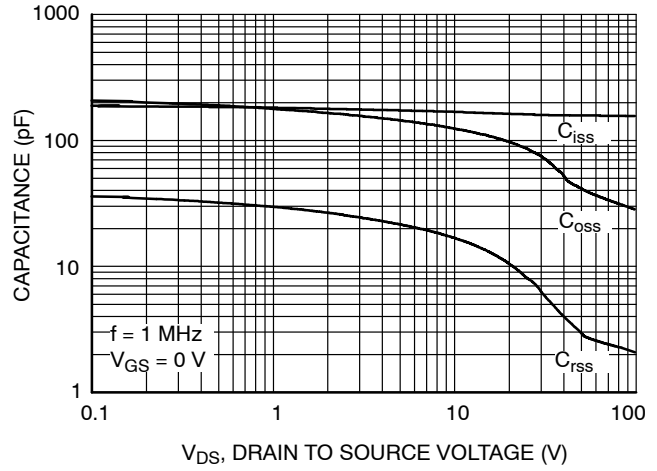

Figure 8. Capacitance vs. Drain to Source Voltage

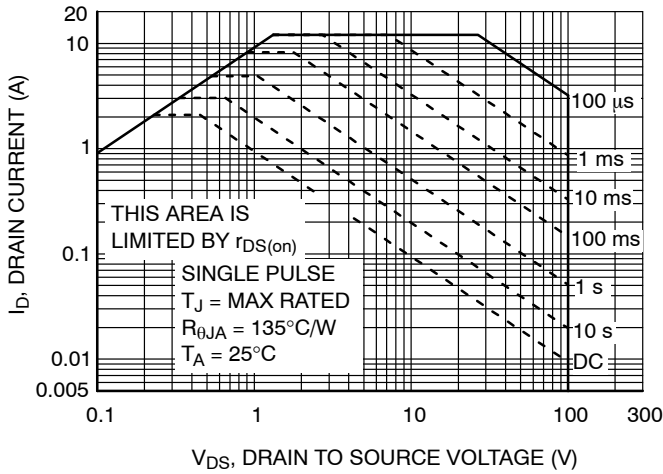

Figure 9. Forward Bias Safe Operating Area

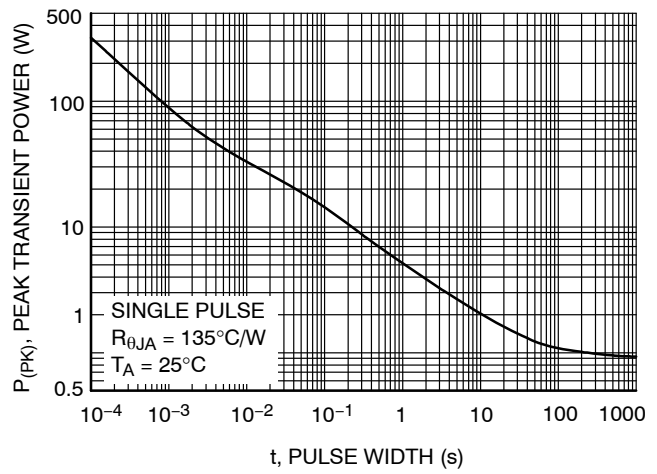

Figure 10. Single Pulse Maximum Power Dissipation

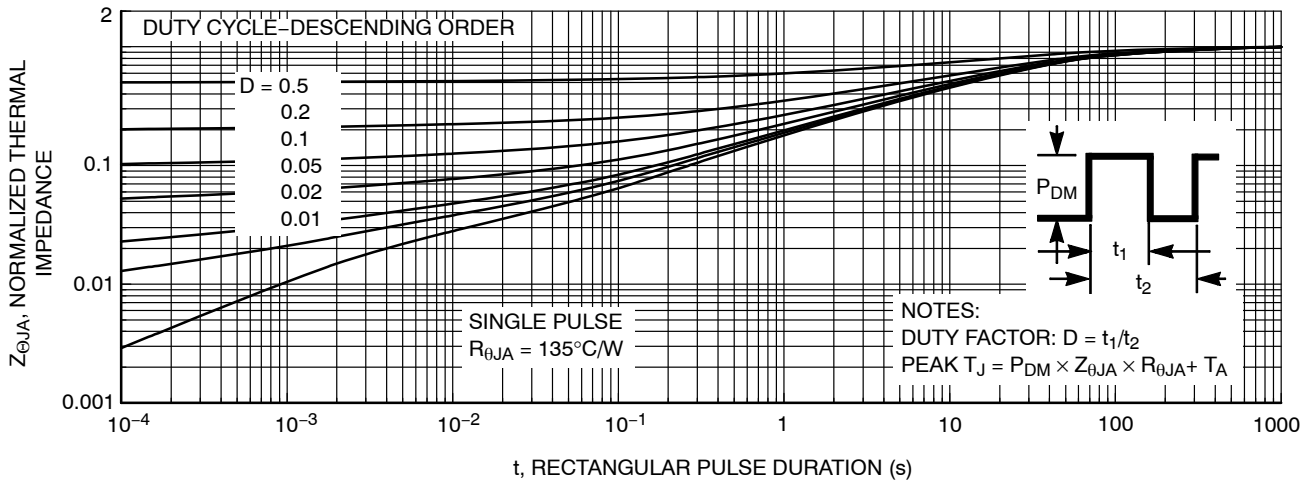

Figure 11. Junction-to-Ambient Transient Thermal Response Curve

# FDMQ8403

## ORDERING INFORMATION

Device Marking	Device	Package	Reel Size	Tape Width	Shipping†
FDMQ8403	FDMQ8403	WDFN12 (Pb-Free)	13"	12 mm	3000 / Tape & Reel

†For information on tape and reel specifications, including part orientation and tape sizes, please refer to our Tape and Reel Packaging Specifications Brochure, [BRD8011/D](#).

GreenBridge is a trademark of Semiconductor Components Industries, LLC dba "onsemi" or its affiliates and/or subsidiaries in the United States and/or other countries.

POWERTRENCH is a registered trademark of Semiconductor Components Industries, LLC dba "onsemi" or its affiliates and/or subsidiaries in the United States and/or other countries.



**onsemi**, **Onsemi**, and other names, marks, and brands are registered and/or common law trademarks of Semiconductor Components Industries, LLC dba "**onsemi**" or its affiliates and/or subsidiaries in the United States and/or other countries. **onsemi** owns the rights to a number of patents, trademarks, copyrights, trade secrets, and other intellectual property. A listing of **onsemi**'s product/patent coverage may be accessed at [www.onsemi.com/site/pdf/Patent-Marking.pdf](http://www.onsemi.com/site/pdf/Patent-Marking.pdf). **onsemi** reserves the right to make changes at any time to any products or information herein, without notice. The information herein is provided "as-is" and **onsemi** makes no warranty, representation or guarantee regarding the accuracy of the information, product features, availability, functionality, or suitability of its products for any particular purpose, nor does **onsemi** assume any liability arising out of the application or use of any product or circuit, and specifically disclaims any and all liability, including without limitation special, consequential or incidental damages. Buyer is responsible for its products and applications using **onsemi** products, including compliance with all laws, regulations and safety requirements or standards, regardless of any support or applications information provided by **onsemi**. "Typical" parameters which may be provided in **onsemi** data sheets and/or specifications can and do vary in different applications and actual performance may vary over time. All operating parameters, including "Typicals" must be validated for each customer application by customer's technical experts. **onsemi** does not convey any license under any of its intellectual property rights nor the rights of others. **onsemi** products are not designed, intended, or authorized for use as a critical component in life support systems or any FDA Class 3 medical devices or medical devices with a same or similar classification in a foreign jurisdiction or any devices intended for implantation in the human body. Should Buyer purchase or use **onsemi** products for any such unintended or unauthorized application, Buyer shall indemnify and hold **onsemi** and its officers, employees, subsidiaries, affiliates, and distributors harmless against all claims, costs, damages, and expenses, and reasonable attorney fees arising out of, directly or indirectly, any claim of personal injury or death associated with such unintended or unauthorized use, even if such claim alleges that **onsemi** was negligent regarding the design or manufacture of the part. **onsemi** is an Equal Opportunity/Affirmative Action Employer. This literature is subject to all applicable copyright laws and is not for resale in any manner.

---

## ADDITIONAL INFORMATION

### TECHNICAL PUBLICATIONS:

Technical Library: [www.onsemi.com/design/resources/technical-documentation](http://www.onsemi.com/design/resources/technical-documentation)  
onsemi Website: [www.onsemi.com](http://www.onsemi.com)

### ONLINE SUPPORT: [www.onsemi.com/support](http://www.onsemi.com/support)

For additional information, please contact your local Sales Representative at [www.onsemi.com/support/sales](http://www.onsemi.com/support/sales)