

Thank you for your interest in **onsemi** products.
Your technical document begins on the following pages.



Your Feedback is Important to Us!

Please take a moment to participate in our short survey.
At **onsemi**, we are dedicated to delivering technical content that best meets your needs.

[Help Us Improve – Take the Survey](#)

This survey is intended to collect your feedback, capture any issues you may encounter, and to provide improvements you would like to suggest.

We look forward to your feedback.

To learn more about **onsemi**, please visit our website at
www.onsemi.com

onsemi and **onsemi** and other names, marks, and brands are registered and/or common law trademarks of Semiconductor Components Industries, LLC dba "**onsemi**" or its affiliates and/or subsidiaries in the United States and/or other countries. **onsemi** owns the rights to a number of patents, trademarks, copyrights, trade secrets, and other intellectual property. A listing of **onsemi** product/patent coverage may be accessed at www.onsemi.com/site/pdf/Patent-Marking.pdf. **onsemi** reserves the right to make changes at any time to any products or information herein, without notice. The information herein is provided "as-is" and **onsemi** makes no warranty, representation or guarantee regarding the accuracy of the information, product features, availability, functionality, or suitability of its products for any particular purpose, nor does **onsemi** assume any liability arising out of the application or use of any product or circuit, and specifically disclaims any and all liability, including without limitation special, consequential or incidental damages. Buyer is responsible for its products and applications using **onsemi** products, including compliance with all laws, regulations and safety requirements or standards, regardless of any support or applications information provided by **onsemi**. "Typical" parameters which may be provided in **onsemi** data sheets and/or specifications can and do vary in different applications and actual performance may vary over time. All operating parameters, including "Typicals" must be validated for each customer application by customer's technical experts. **onsemi** does not convey any license under any of its intellectual property rights nor the rights of others. **onsemi** products are not designed, intended, or authorized for use as a critical component in life support systems or any FDA Class 3 medical devices or medical devices with a same or similar classification in a foreign jurisdiction or any devices intended for implantation in the human body. Should Buyer purchase or use **onsemi** products for any such unintended or unauthorized application, Buyer shall indemnify and hold **onsemi** and its officers, employees, subsidiaries, affiliates, and distributors harmless against all claims, costs, damages, and expenses, and reasonable attorney fees arising out of, directly or indirectly, any claim of personal injury or death associated with such unintended or unauthorized use, even if such claim alleges that **onsemi** was negligent regarding the design or manufacture of the part. **onsemi** is an Equal Opportunity/Affirmative Action Employer. This literature is subject to all applicable copyright laws and is not for resale in any manner. Other names and brands may be claimed as the property of others.

MOSFET – N-Channel, POWERTRENCH®

100 V, 40 A, 8.5 mΩ

FDPF085N10A

Description

This N-Channel MOSFET is Produced using onsemi's advanced PowerTrench Process that has been tailored to minimize the on-state resistance while maintaining superior switching performance.

Features

- $R_{DS(on)} = 6.5 \text{ m}\Omega$ (Typ.) @ $V_{GS} = 10 \text{ V}$, $I_D = 40 \text{ A}$
- Fast Switching Speed
- Low Gate Charge, $Q_g = 31 \text{ nC}$ (Typ.)
- High Performance Trench Technology for Extremely Low $R_{DS(on)}$
- High Power and Current Handling Capability
- This Device is Pb-Free Halide, Free and RoHS Compliant

Applications

- Consumer Appliances
- LED TV
- Synchronous Rectification for ATX / Sever / Telecom PSU
- Motor Drives and Uninterruptible Power Supplies
- Micro Solar Inverter

ABSOLUTE MAXIMUM RATINGS

($T_C = 25^\circ\text{C}$ unless otherwise noted.)

Symbol	Parameter	Value	Unit
V_{DSS}	Drain to Source Voltage	100	V
V_{GSS}	Gate to Source Voltage	± 20	V
I_D	Drain Current – Continuous ($T_C = 25^\circ\text{C}$) – Continuous ($T_C = 100^\circ\text{C}$)	40 28	A
I_{DM}	Drain Current – Pulsed (Note 1)	160	A
E_{AS}	Single Pulsed Avalanche Energy (Note 2)	269	mJ
dv/dt	Peak Diode Recovery dv/dt (Note 3)	6.0	V/ns
P_D	Power Dissipation – ($T_C = 25^\circ\text{C}$) – Derate Above 25°C	33.3 0.22	W W/ $^\circ\text{C}$
T_J, T_{STG}	Operating and Storage Temperature Range	-55 to +150	$^\circ\text{C}$
T_L	Maximum Lead Temperature for Soldering Purpose, 1/8" from Case for 5 Seconds	300	$^\circ\text{C}$

Stresses exceeding those listed in the Maximum Ratings table may damage the device. If any of these limits are exceeded, device functionality should not be assumed, damage may occur and reliability may be affected.

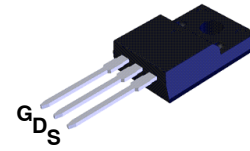

TO-220F
CASE 221AT

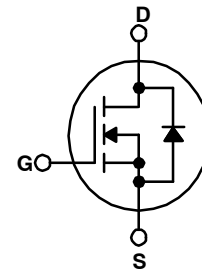

MARKING DIAGRAM

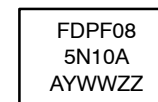

FDPF085N10A = Specific Device Code
A = Assembly Location
YWW = Date Code (Year and Week)
ZZ = Assembly Lot Code

ORDERING INFORMATION

Device	Package	Shipping
FDPF085N10A	TO-220-3 FullPack	1000 Units / Tube

†For information on tape and reel specifications, including part orientation and tape sizes, please refer to our Tape and Reel Packaging Specifications Brochure, [BRD8011/D](#).

FDPF085N10A

THERMAL CHARACTERISTICS

Symbol	Parameter	Value	Unit
$R_{\theta JC}$	Thermal Resistance, Junction to Case, Max.	4.5	°C/W
$R_{\theta JA}$	Thermal Resistance, Junction to Ambient, Max.	62.5	

ELECTRICAL CHARACTERISTICS (T_C = 25°C unless otherwise noted)

Symbol	Parameter	Test Conditions	Min	Typ	Max	Unit
Off Characteristics						
BV_{DSS}	Drain to Source Breakdown Voltage	$I_D = 250 \mu A, V_{GS} = 0 V$	100	–	–	V
$\frac{\Delta BV_{DSS}}{\Delta T_J}$	Breakdown Voltage Temperature Coefficient	$I_D = 250 \mu A$, Referenced to 25°C	–	0.07	–	V/°C
I_{DSS}	Zero Gate Voltage Drain Current	$V_{DS} = 80 V, V_{GS} = 0 V$	–	–	1	μA
		$V_{DS} = 80 V, T_C = 150^\circ C$	–	–	500	
I_{GSS}	Gate to Body Leakage Current	$V_{GS} = \pm 20 V, V_{DS} = 0 V$	–	–	± 100	nA

On Characteristics

$V_{GS(th)}$	Gate Threshold Voltage	$V_{GS} = V_{DS}, I_D = 250 \mu A$	2.0	–	4.0	V
$R_{DS(on)}$	Static Drain to Source On-Resistance	$V_{GS} = 10 V, I_D = 96 A$	–	6.5	8.5	m Ω
g_{FS}	Forward Transconductance	$V_{DS} = 10 V, I_D = 96 A$	–	76	–	S

Dynamic Characteristics

C_{iss}	Input Capacitance	$V_{DS} = 50 V, V_{GS} = 0 V, f = 1 MHz$	–	2025	2695	pF
C_{oss}	Output Capacitance		–	468	620	
C_{rss}	Reverse Transfer Capacitance		–	20	–	
$C_{oss(er)}$	Energy Related Output Capacitance	$V_{DS} = 50 V, V_{GS} = 0 V$	–	752	–	pF
$Q_{g(tot)}$	Total Gate Charge at 10 V	$V_{GS} = 10 V, V_{DS} = 50 V, I_D = 96 A$ (Note 4)	–	31	40	nC
Q_{gs}	Gate to Source Gate Charge		–	9.7	–	
Q_{gs2}	Gate Charge Threshold to Plateau		–	5.0	–	
Q_{gd}	Gate to Drain “Miller” Charge		–	7.5	–	
ESR	Equivalent Series Resistance (G-S)	$f = 1 MHz$	–	0.97	–	Ω

Switching Characteristics

$t_{d(on)}$	Turn-On Delay Time	$V_{DD} = 50 V, I_D = 96 A,$ $V_{GS} = 10 V, R_G = 4.7 \Omega$ (Note 4)	–	18	46	ns
t_r	Turn-On Rise Time		–	22	54	
$t_{d(off)}$	Turn-Off Delay Time		–	29	68	
t_f	Turn-Off Fall Time		–	8	26	

Drain-Source Diode Characteristics and Maximum Ratings

I_S	Maximum Continuous Drain to Source Diode Forward Current	–	–	40	A	
I_{SM}	Maximum Pulsed Drain to Source Diode Forward Current	–	–	160	A	
V_{SD}	Drain to Source Diode Forward Voltage	$V_{GS} = 0 V, I_{SD} = 96 A$	–	–	1.3	V
t_{rr}	Reverse Recovery Time	$V_{DD} = 50 V, V_{GS} = 0 V, I_{SD} = 96 A,$ $di/dt = 100 A/\mu s$	–	59	–	ns
Q_{rr}	Reverse Recovery Charge		–	80	–	nC

Product parametric performance is indicated in the Electrical Characteristics for the listed test conditions, unless otherwise noted. Product performance may not be indicated by the Electrical Characteristics if operated under different conditions.

NOTES:

1. Repetitive Rating: Pulse-width limited by maximum junction temperature.
2. L = 3 mH, $I_{AS} = 13.4 A$, $R_G = 25 \Omega$ starting $T_J = 25^\circ C$.
3. $I_{SD} \leq 40 A$, $di/dt \leq 200 A/\mu s$, $V_{DD} \leq BV_{DSS}$, starting $T_J = 25^\circ C$.
4. Essentially independent of operating temperature.

TYPICAL CHARACTERISTICS

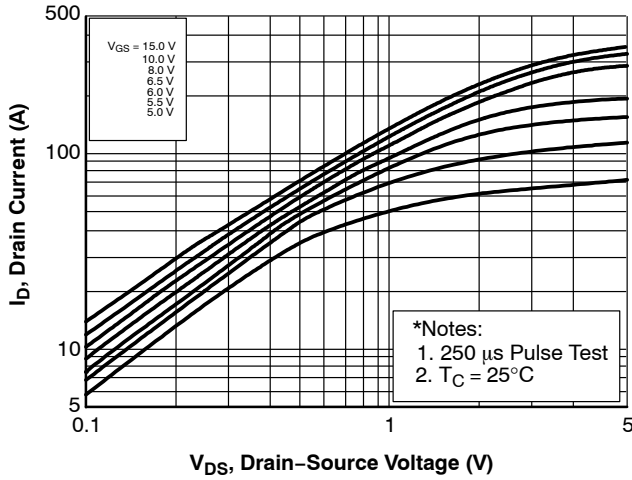

Figure 1. On-Region Characteristics

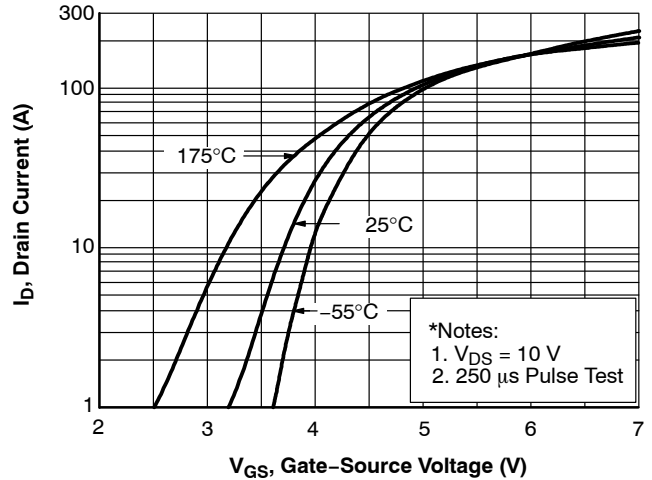

Figure 2. Transfer Characteristics

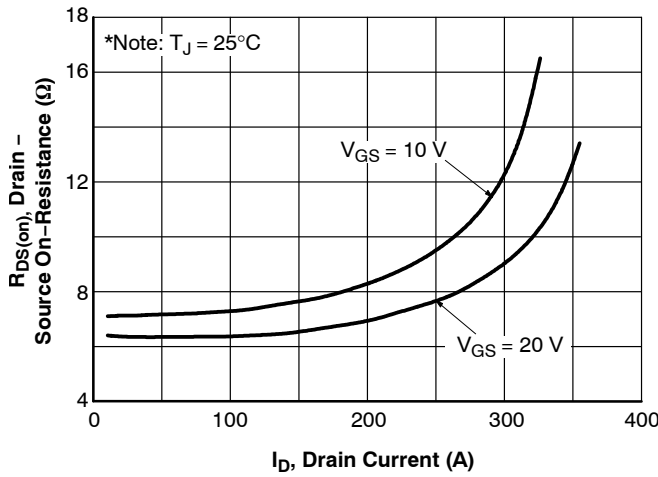

Figure 3. On-Resistance Variation vs Drain Current and Gate Voltage

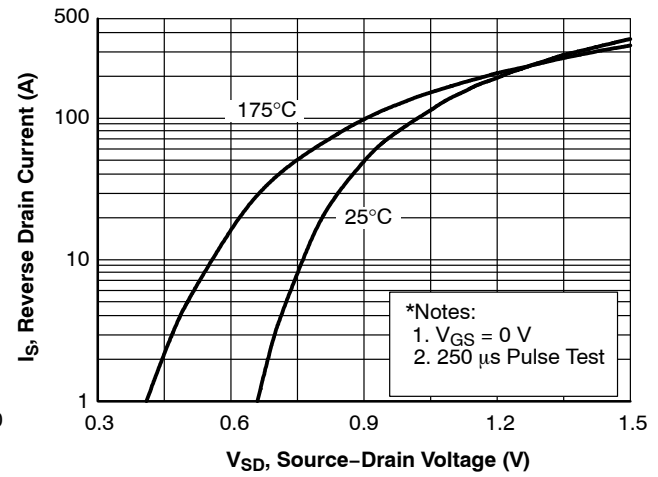

Figure 4. Body Diode Forward Voltage Variation vs Source Current and Temperature

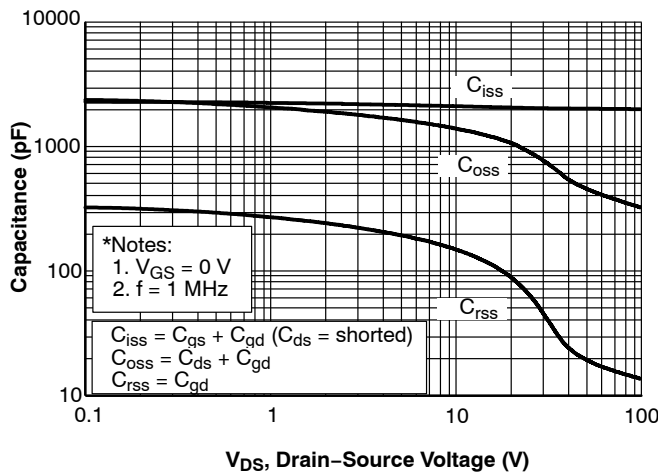

Figure 5. Capacitance Characteristics

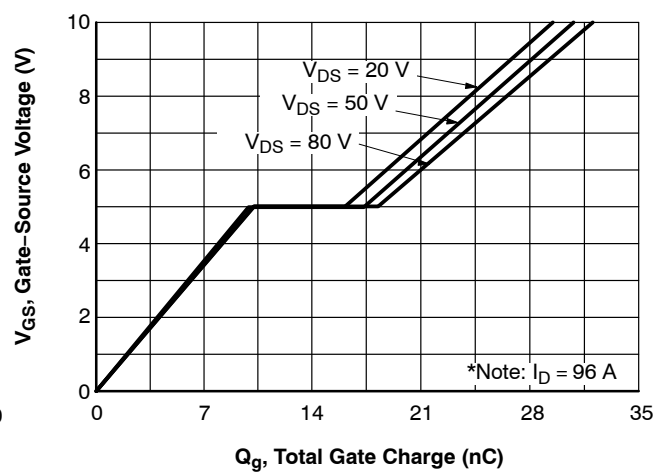

Figure 6. Gate Charge Characteristics

TYPICAL CHARACTERISTICS (CONTINUED)

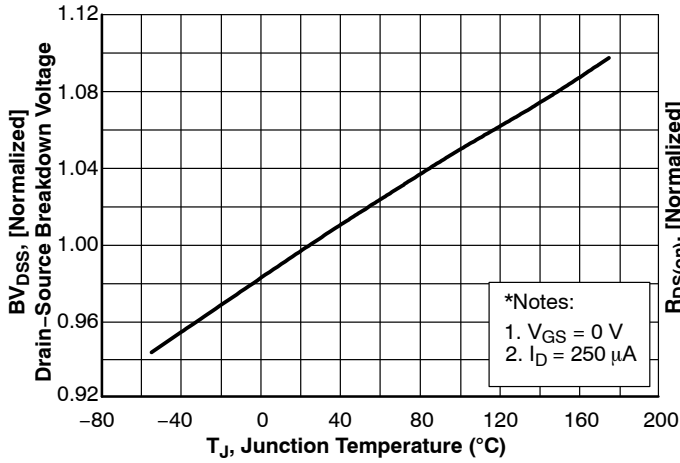

Figure 7. Breakdown Voltage Variation vs Temperature

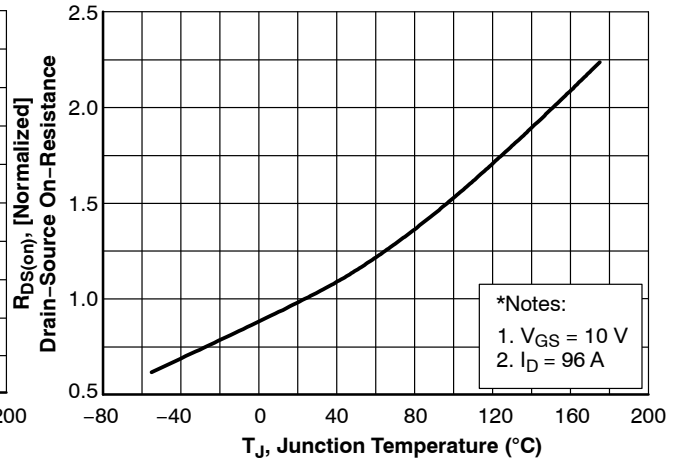

Figure 8. On-Resistance Variation vs Temperature

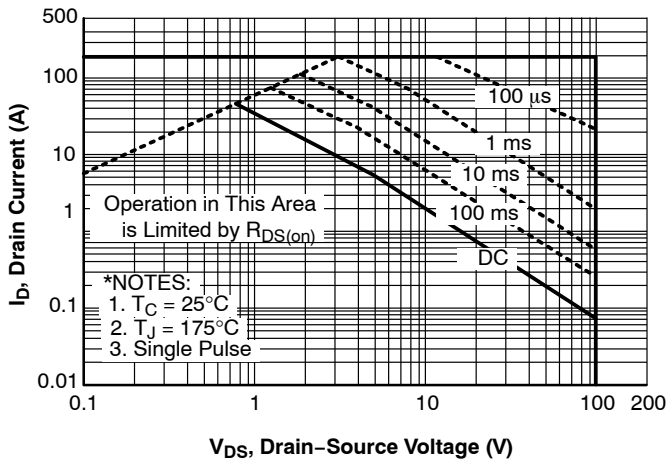

Figure 9. Maximum Safe Operating Area

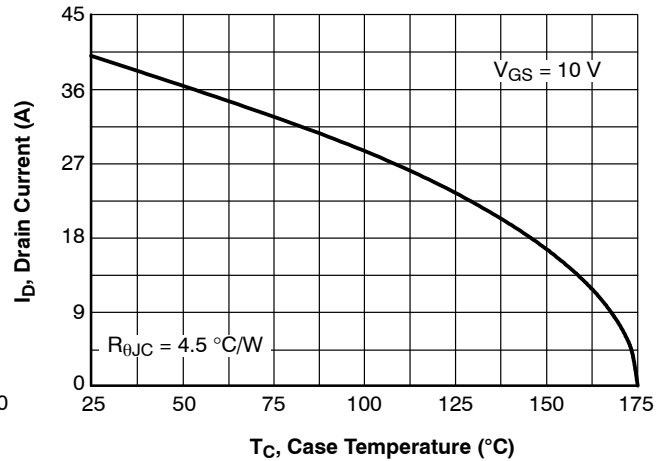

Figure 10. Maximum Drain Current vs. Case Temperature

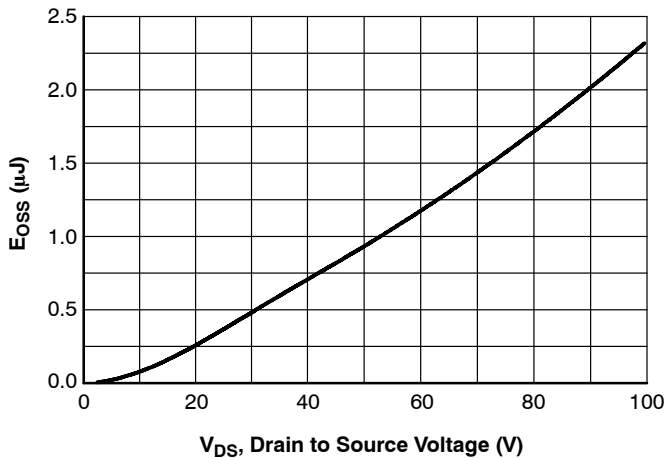

Figure 11. E_{oss} vs. Drain to Source Voltage

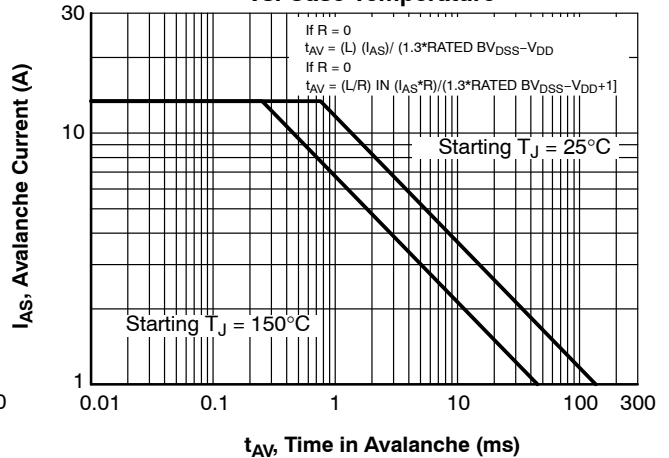
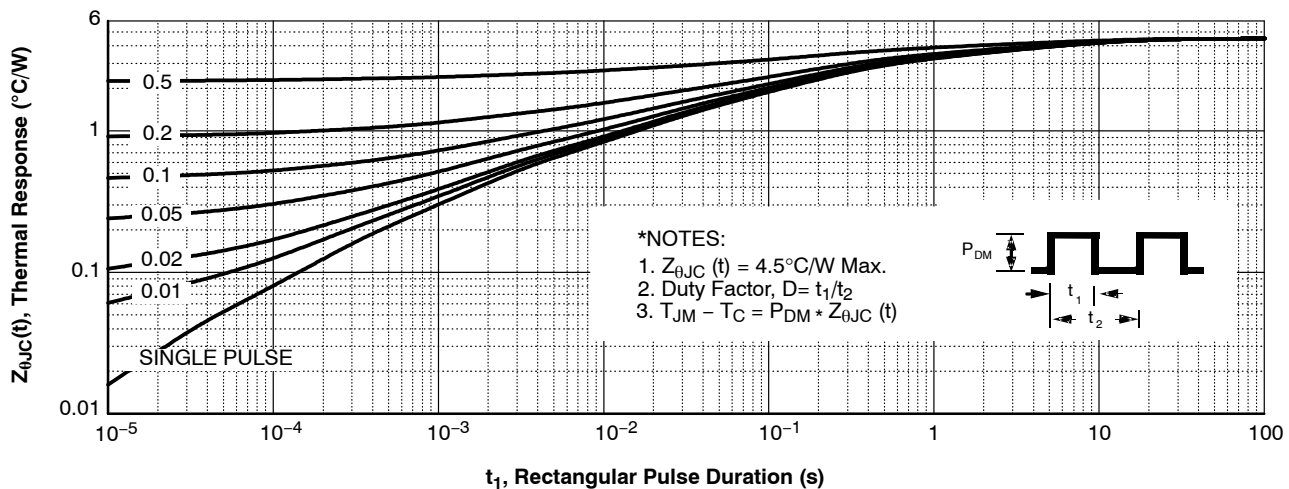

Figure 12. Unclamped Inductive Switching Capability

FDPF085N10A

TYPICAL CHARACTERISTICS (CONTINUED)



FDPF085N10A

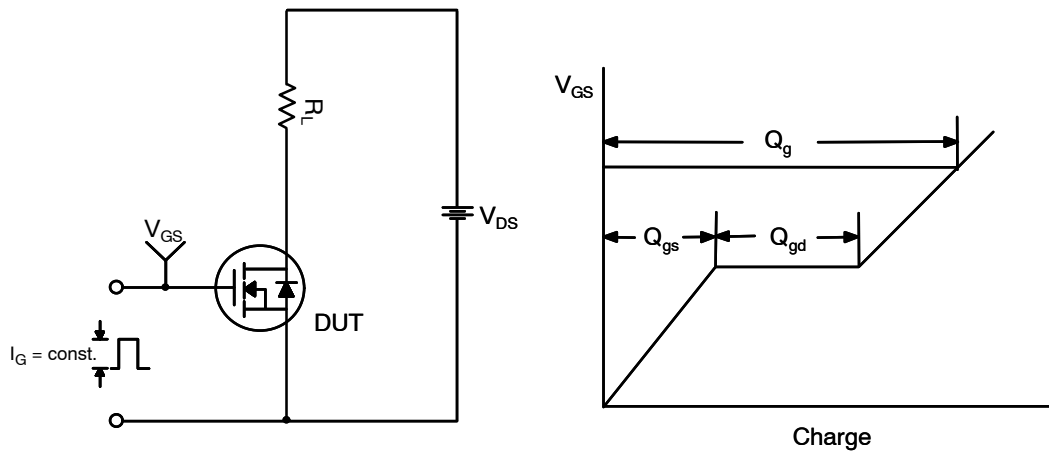

Figure 14. Gate Charge Test Circuit & Waveform

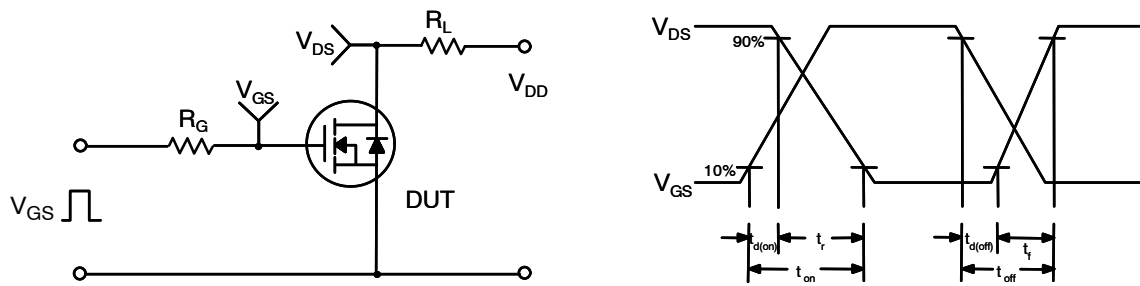

Figure 15. Resistive Switching Test Circuit & Waveforms

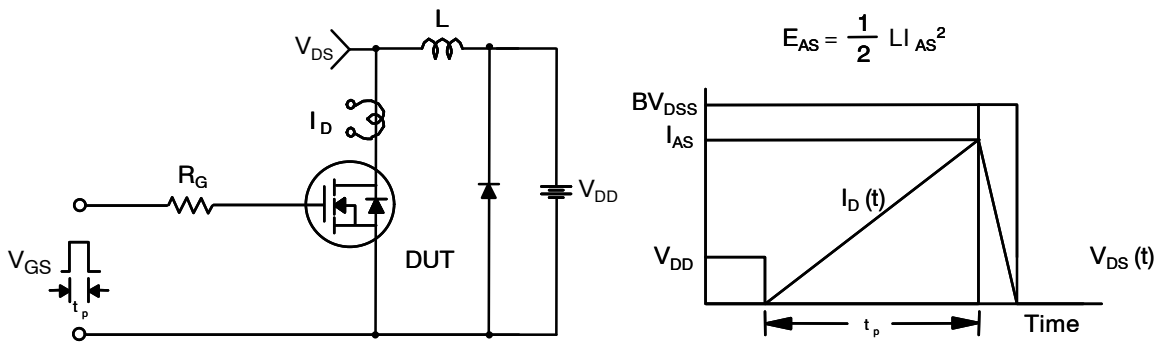

Figure 16. Unclamped Inductive Switching Test Circuit & Waveforms

FDPF085N10A

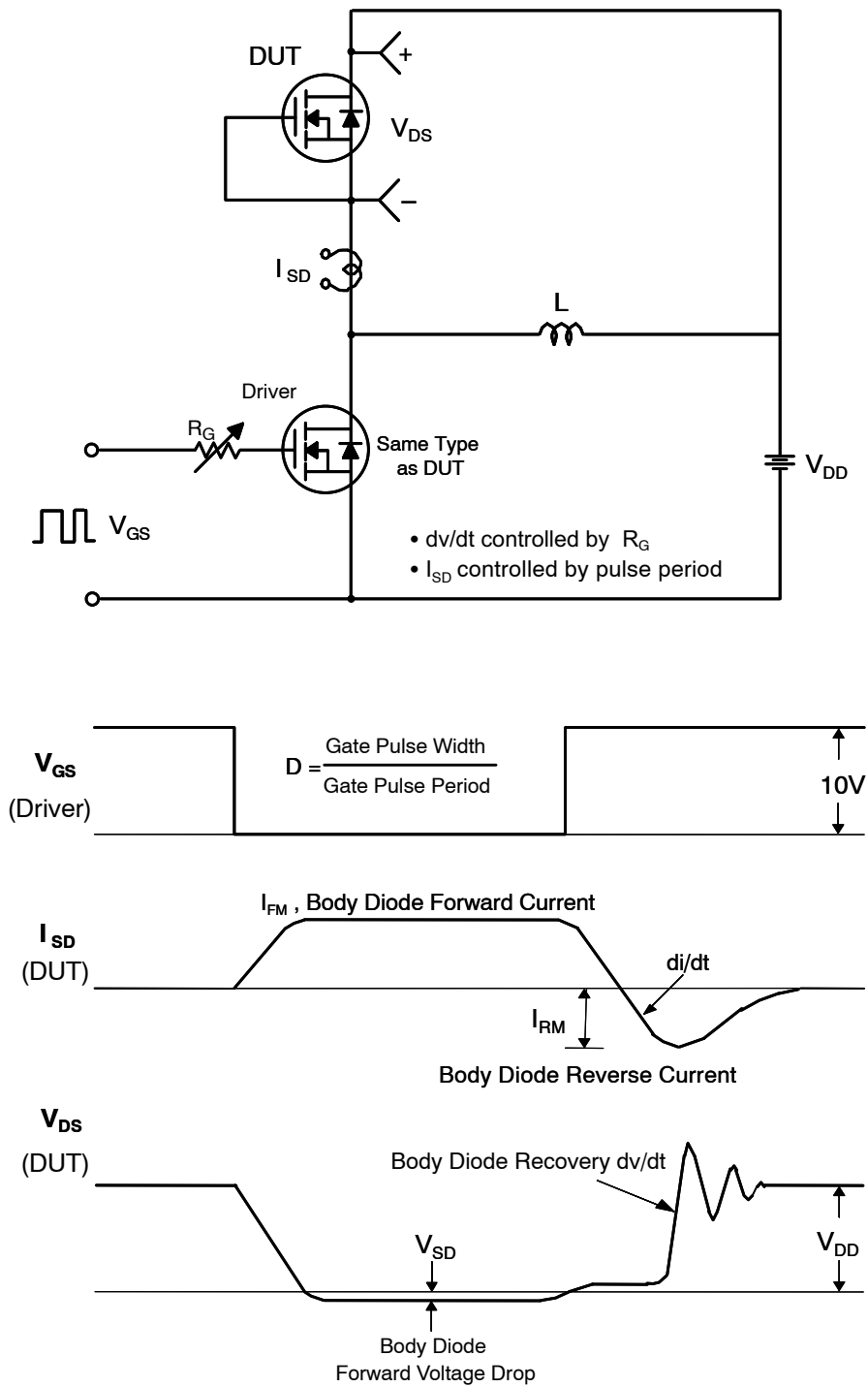

Figure 17. Peak Diode Recovery dv/dt Test Circuit & Waveforms

MECHANICAL CASE OUTLINE

PACKAGE DIMENSIONS

ON Semiconductor®



TO-220 Fullpack, 3-Lead / TO-220F-3SG CASE 221AT ISSUE B

DATE 19 JAN 2021



Scale 1:1

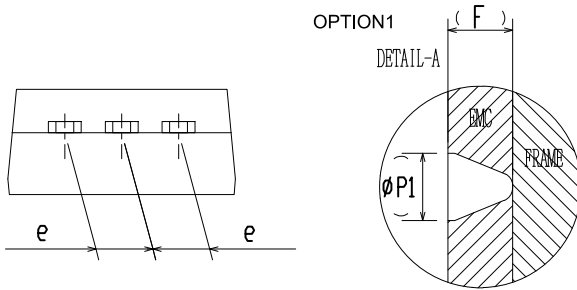
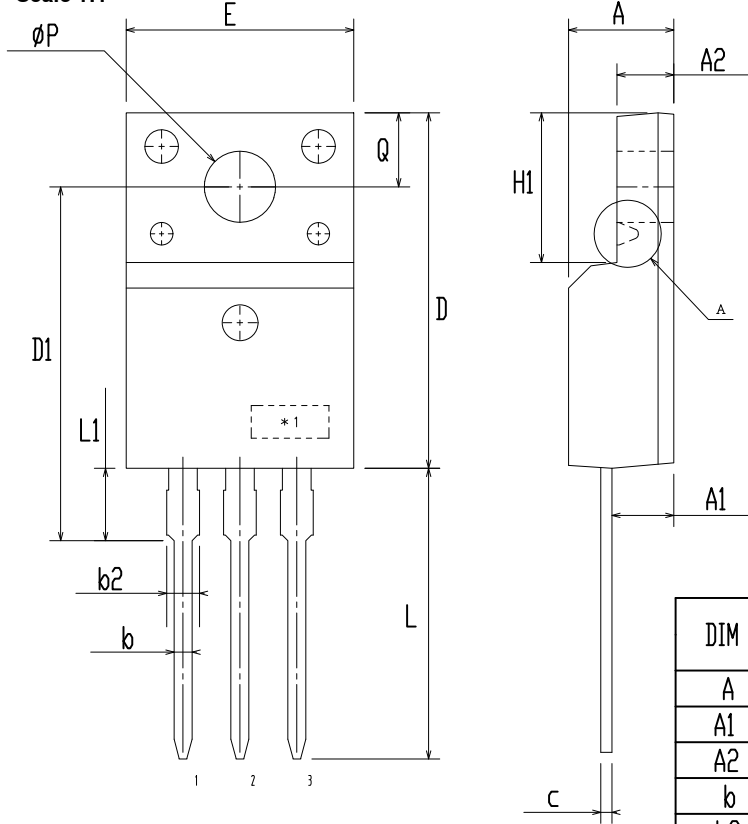

DIM	MILLIMETERS		
	MIN	NOM	MAX
A	4.50	4.70	4.90
A1	2.56	2.76	2.96
A2	2.34	2.54	2.74
b	0.70	0.80	0.90
b2	~	~	1.47
c	0.45	0.50	0.60
D	15.67	15.87	16.07
D1	15.60	15.80	16.00
E	9.96	10.16	10.36
e	2.34	2.54	2.74
F	~	0.84	~
H1	6.48	6.68	6.88
L	12.78	12.98	13.18
L1	3.03	3.23	3.43
phi P	2.98	3.18	3.38
phi P1	~	1.00	~
Q	3.20	3.30	3.40

NOTES:

- A. DIMENSION AND TOLERANCE AS ASME Y14.5-2009
- B. DIMENSIONS ARE EXCLUSIVE OF BURRS, MOLD FLASH AND TIE BAR PROTRUCTIONS.
- C. OPTION 1 - WITH SUPPORT PIN HOLE
OPTION 2 - NO SUPPORT PIN HOLE

DOCUMENT NUMBER:	98AON67439E	Electronic versions are uncontrolled except when accessed directly from the Document Repository. Printed versions are uncontrolled except when stamped "CONTROLLED COPY" in red.
DESCRIPTION:	TO-220 FULLPACK, 3-LEAD / TO-220F-3SG	PAGE 1 OF 1

ON Semiconductor and are trademarks of Semiconductor Components Industries, LLC dba ON Semiconductor or its subsidiaries in the United States and/or other countries. ON Semiconductor reserves the right to make changes without further notice to any products herein. ON Semiconductor makes no warranty, representation or guarantee regarding the suitability of its products for any particular purpose, nor does ON Semiconductor assume any liability arising out of the application or use of any product or circuit, and specifically disclaims any and all liability, including without limitation special, consequential or incidental damages. ON Semiconductor does not convey any license under its patent rights nor the rights of others.

onsemi, **Onsemi**, and other names, marks, and brands are registered and/or common law trademarks of Semiconductor Components Industries, LLC dba "**onsemi**" or its affiliates and/or subsidiaries in the United States and/or other countries. **onsemi** owns the rights to a number of patents, trademarks, copyrights, trade secrets, and other intellectual property. A listing of **onsemi**'s product/patent coverage may be accessed at www.onsemi.com/site/pdf/Patent-Marking.pdf. **onsemi** reserves the right to make changes at any time to any products or information herein, without notice. The information herein is provided "as-is" and **onsemi** makes no warranty, representation or guarantee regarding the accuracy of the information, product features, availability, functionality, or suitability of its products for any particular purpose, nor does **onsemi** assume any liability arising out of the application or use of any product or circuit, and specifically disclaims any and all liability, including without limitation special, consequential or incidental damages. Buyer is responsible for its products and applications using **onsemi** products, including compliance with all laws, regulations and safety requirements or standards, regardless of any support or applications information provided by **onsemi**. "Typical" parameters which may be provided in **onsemi** data sheets and/or specifications can and do vary in different applications and actual performance may vary over time. All operating parameters, including "Typicals" must be validated for each customer application by customer's technical experts. **onsemi** does not convey any license under any of its intellectual property rights nor the rights of others. **onsemi** products are not designed, intended, or authorized for use as a critical component in life support systems or any FDA Class 3 medical devices or medical devices with a same or similar classification in a foreign jurisdiction or any devices intended for implantation in the human body. Should Buyer purchase or use **onsemi** products for any such unintended or unauthorized application, Buyer shall indemnify and hold **onsemi** and its officers, employees, subsidiaries, affiliates, and distributors harmless against all claims, costs, damages, and expenses, and reasonable attorney fees arising out of, directly or indirectly, any claim of personal injury or death associated with such unintended or unauthorized use, even if such claim alleges that **onsemi** was negligent regarding the design or manufacture of the part. **onsemi** is an Equal Opportunity/Affirmative Action Employer. This literature is subject to all applicable copyright laws and is not for resale in any manner.

ADDITIONAL INFORMATION

TECHNICAL PUBLICATIONS:

Technical Library: www.onsemi.com/design/resources/technical-documentation
onsemi Website: www.onsemi.com

ONLINE SUPPORT: www.onsemi.com/support

For additional information, please contact your local Sales Representative at www.onsemi.com/support/sales