

MOSFET – Dual, N-Channel, POWERTRENCH[®], SyncFET[™]

FDS6900AS, FDS6900AS-G

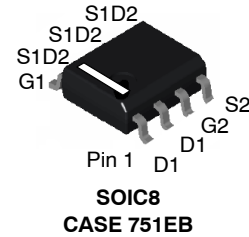

General Description

The FDS6900AS is designed to replace two single SO-8 MOSFETs and Schottky diode in synchronous dc-dc power supplies that provide various peripheral voltages for notebook computers and other battery powered electronic devices. FDS6900AS contains two unique 30 V, N-channel, logic level, POWERTRENCH MOSFETs designed to maximize power conversion efficiency.

The high-side switch (Q1) is designed with specific emphasis on reducing switching losses while the lowside switch (Q2) is optimized to reduce conduction losses. Q2 also includes an integrated Schottky diode using onsemi's monolithic SyncFET technology.

Features

- **Q2:** Optimized to Minimize Conduction Losses Includes SyncFET Schottky Body Diode, 8.2 A, 30 V
 - ♦ $R_{DS(on)} = 22\text{ m}\Omega$ at $V_{GS} = 10\text{ V}$
 - ♦ $R_{DS(on)} = 28\text{ m}\Omega$ at $V_{GS} = 4.5\text{ V}$
- **Q1:** Optimized for Low Switching Losses Low Gate Charge (11 nC typical), 6.9 A, 30 V
 - ♦ $R_{DS(on)} = 27\text{ m}\Omega$ at $V_{GS} = 10\text{ V}$
 - ♦ $R_{DS(on)} = 34\text{ m}\Omega$ at $V_{GS} = 4.5\text{ V}$
- 100% R_G (Gate Resistance) Tested
- These Devices are Pb-Free and are RoHS Compliant

Specifications

ABSOLUTE MAXIMUM RATINGS ($T_A = 25^\circ\text{C}$ unless otherwise noted)

Symbol	Parameter	Q2	Q1	Units
V_{DSS}	Drain-Source Voltage	30	30	V
V_{GSS}	Gate-Source Voltage	± 20	± 20	V
I_D	Drain Current			A
	- Continuous (Note 1a)	8.2	6.9	
	- Pulsed	30	20	
P_D	Power Dissipation for Dual Operation	2		W
	Power Dissipation for Single Operation (Note 1a)	1.6		
	(Note 1b)	1		
	(Note 1c)	0.9		
T_J, T_{STG}	Operating and Storage Junction Temperature Range	-55 to +150		$^\circ\text{C}$

Stresses exceeding those listed in the Maximum Ratings table may damage the device. If any of these limits are exceeded, device functionality should not be assumed, damage may occur and reliability may be affected.

ELECTRICAL CONNECTION

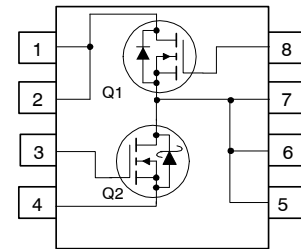

Dual N-Channel SyncFet

MARKING DIAGRAM

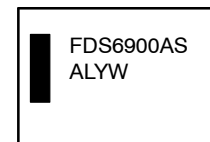

FDS6900AS = Specific Device Code
A = Assembly Site
L = Wafer Lot Number
YW = Assembly Start Week

ORDERING INFORMATION

Device	Package	Shipping [†]
FDS6900AS	SOIC8 (Pb-Free)	2,500 / Tape & Reel
FDS6900AS-G	SOIC8 (Pb-Free)	2,500 / Tape & Reel

[†]For information on tape and reel specifications, including part orientation and tape sizes, please refer to our Tape and Reel Packaging Specification Brochure, [BRD8011/D](#).

FDS6900AS, FDS6900AS-G

THERMAL CHARACTERISTICS

Symbol	Parameter	Ratings	Units
$R_{\theta JA}$	Thermal Resistance, Junction-to-Ambient (Note 1a)	78	$^{\circ}\text{C}/\text{W}$
$R_{\theta JC}$	Thermal Resistance, Junction-to-Case (Note 1)	40	$^{\circ}\text{C}/\text{W}$

Table 1. ELECTRICAL CHARACTERISTICS ($T_A = 25^{\circ}\text{C}$ unless otherwise noted)

Symbol	Parameter	Conditions	Type	Min	Typ	Max	Units
--------	-----------	------------	------	-----	-----	-----	-------

OFF CHARACTERISTICS

BV_{DSS}	Drain to Source Breakdown Voltage	$I_D = 1 \text{ mA}, V_{GS} = 0 \text{ V}$ $I_D = 250 \mu\text{A}, V_{GS} = 0 \text{ V}$	Q2 Q1	30 30			V
$\Delta BV_{DSS} / \Delta T_J$	Breakdown Voltage Temperature Coefficient	$I_D = 10 \text{ mA}$, referenced to 25°C $I_D = 250 \mu\text{A}$, referenced to 25°C	Q2 Q1		27 22		$\text{mV}/^{\circ}\text{C}$
I_{DSS}	Zero Gate Voltage Drain Current	$V_{DS} = 24 \text{ V}, V_{GS} = 0 \text{ V}$	Q2 Q1			500 1	μA
I_{GSS}	Gate-Body Leakage Current	$V_{GS} = \pm 20 \text{ V}, V_{DS} = 0 \text{ V}$	Q2 Q1			± 100	nA

ON CHARACTERISTICS (Note 2)

$V_{GS(th)}$	Gate to Source Threshold Voltage	$V_{GS} = V_{DS}, I_D = 1 \text{ mA}$ $V_{GS} = V_{DS}, I_D = 250 \mu\text{A}$	Q2 Q1	1 1	1.9 1.9	3 3	V
$\Delta V_{GS(th)} / \Delta T_J$	Gate to Source Threshold Voltage Temperature Coefficient	$I_D = 10 \text{ mA}$, referenced to 25°C $I_D = 250 \mu\text{A}$, referenced to 25°C	Q2 Q1		-3.2 -4.2		$\text{mV}/^{\circ}\text{C}$
$R_{DS(on)}$	Static Drain-Source On-Resistance	$V_{GS} = 10 \text{ V}, I_D = 8.2 \text{ A}$ $V_{GS} = 10 \text{ V}, I_D = 8.2 \text{ A}, T_J = 125^{\circ}\text{C}$ $V_{GS} = 4.5 \text{ V}, I_D = 7.6 \text{ A}$	Q2		17 23 21	22 36 28	$\text{m}\Omega$
		$V_{GS} = 10 \text{ V}, I_D = 6.9 \text{ A}$ $V_{GS} = 10 \text{ V}, I_D = 6.9 \text{ A}, T_J = 125^{\circ}\text{C}$ $V_{GS} = 4.5 \text{ V}, I_D = 6.2 \text{ A}$	Q1		22 30 27	27 38 34	
$I_{D(on)}$	On-State Drain Current	$V_{GS} = 10 \text{ V}, V_{DS} = 5 \text{ V}$	Q2 Q1	30 20			A
g_{FS}	Forward Transconductance	$V_{DS} = 5 \text{ V}, I_D = 8.2 \text{ A}$ $V_{DS} = 5 \text{ V}, I_D = 6.9 \text{ A}$	Q2 Q1		25 21		S

DYNAMIC CHARACTERISTICS

C_{iss}	Input Capacitance	$V_{DS} = 15 \text{ V}, V_{GS} = 0 \text{ V}, f = 1 \text{ MHz}$	Q2 Q1		570 600		pF
C_{oss}	Output Capacitance		Q2 Q1		180 150		pF
C_{rss}	Reverse Transfer Capacitance		Q2 Q1		70 70		pF
R_G	Gate Resistance		Q2 Q1		2.8 2.2	4.9 3.8	Ω

SWITCHING CHARACTERISTICS (Note 2)

$t_{d(on)}$	Turn-On Delay Time	$V_{DD} = 15 \text{ V}, I_D = 1 \text{ A}, V_{GS} = 10 \text{ V}, R_{GEN} = 6 \Omega$	Q2 Q1		10 9	19 18	ns
t_r	Turn-On Rise Time		Q2 Q1		5 4	10 8	ns
$t_{d(off)}$	Turn-Off Delay Time		Q2 Q1		26 23	42 32	ns
t_f	Turn-Off Fall Time		Q2 Q1		3 3	6 6	ns

FDS6900AS, FDS6900AS-G

Table 1. ELECTRICAL CHARACTERISTICS ($T_A = 25^\circ\text{C}$ unless otherwise noted) (continued)

Symbol	Parameter	Conditions	Type	Min	Typ	Max	Units
SWITCHING CHARACTERISTICS (Note 2)							
$t_{d(on)}$	Turn-On Delay Time	$V_{DD} = 15\text{ V}$, $I_D = 1\text{ A}$, $V_{GS} = 4.5\text{ V}$, $R_{GEN} = 6\ \Omega$	Q2		11	20	ns
			Q1		10	19	
t_r	Turn-On Rise Time		Q2		15	27	ns
			Q1		9	18	
$t_{d(off)}$	Turn-Off Delay Time		Q2		16	29	ns
			Q1		14	25	
t_f	Turn-Off Fall Time		Q2		6	12	ns
			Q1		4	8	
$Q_{g(TOT)}$	Total Gate Charge at $V_{GS} = 10\text{ V}$	Q2: $V_{DS} = 15\text{ V}$, $I_D = 8.2\text{ A}$ Q1: $V_{DS} = 15\text{ V}$, $I_D = 6.9\text{ A}$	Q2		10	15	nC
			Q1		11	15	
Q_g	Total Gate Charge at $V_{GS} = 5\text{ V}$		Q2		5.8	8.2	nC
			Q1		6.1	8.5	
Q_{gs}	Gate-Source Charge		Q2		1.6		nC
			Q1		1.7		
Q_{gd}	Gate-Drain Charge		Q2		2.1		nC
		Q1		2.2			

DRAIN-SOURCE DIODE CHARACTERISTICS AND MAXIMUM RATINGS

I_S	Maximum Continuous Drain-Source Diode Forward Current		Q2			2.3	A
			Q1			1.3	
T_{rr}	Reverse Recovery Time	$I_F = 8.2\text{ A}$, $d_iF/d_t = 300\text{ A}/\mu\text{s}$ (Note 3)	Q2		15		ns
Q_{rr}	Reverse Recovery Charge				6		nC
T_{rr}	Reverse Recovery Time	$I_F = 6.9\text{ A}$, $d_iF/d_t = 100\text{ A}/\mu\text{s}$ (Note 3)	Q1		19		ns
Q_{rr}	Reverse Recovery Charge				10		nC
V_{SD}	Drain-Source Diode Forward Voltage	$V_{GS} = 0\text{ V}$, $I_S = 2.3\text{ A}$ (Note 2)	Q2		0.6	0.7	V
		$V_{GS} = 0\text{ V}$, $I_S = 5\text{ A}$ (Note 2)	Q2		0.7	1.0	
		$V_{GS} = 0\text{ V}$, $I_S = 1.3\text{ A}$ (Note 2)	Q1		0.7	1.2	

Product parametric performance is indicated in the Electrical Characteristics for the listed test conditions, unless otherwise noted. Product performance may not be indicated by the Electrical Characteristics if operated under different conditions.

NOTES:

- $R_{\theta JA}$ is the sum of the junction-to-case and case-to-ambient thermal resistance where the case thermal reference is defined as the solder mounting surface of the drain pins. $R_{\theta JC}$ is guaranteed by design while $R_{\theta CA}$ is determined by the user's board design.

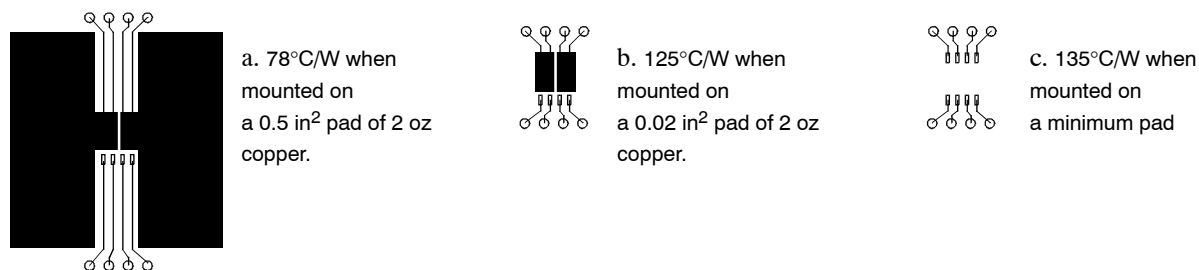

- Pulse Test: Pulse Width $< 300\ \mu\text{s}$, Duty cycle $< 2.0\%$.
- See "SyncFET Schottky body diode characteristics" below.

TYPICAL CHARACTERISTICS: Q2

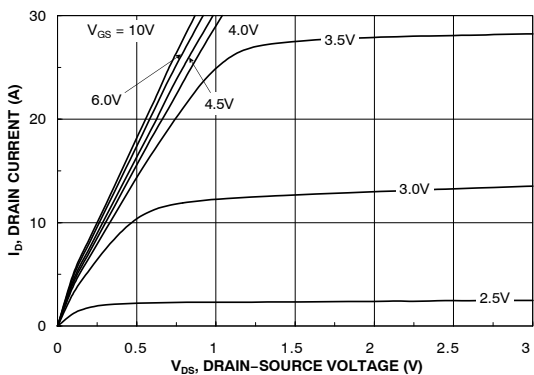

Figure 1. On-Region Characteristics

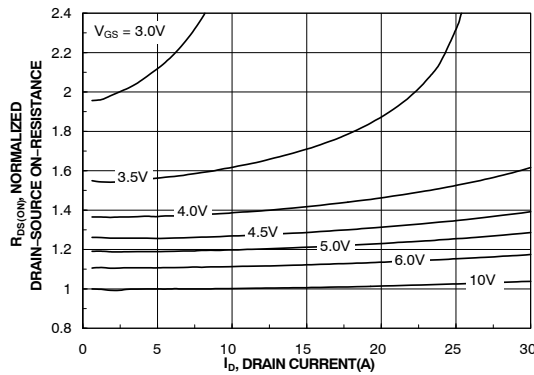

Figure 2. On-Resistance Variation with Drain Current and Gate Voltage

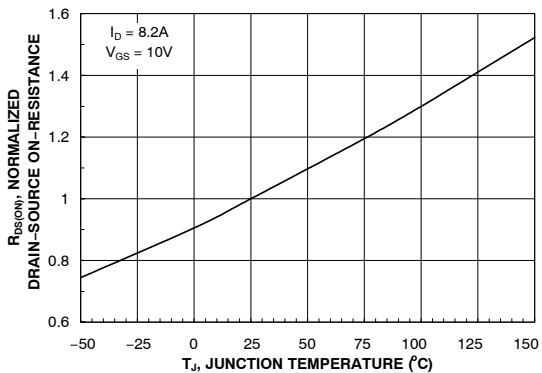

Figure 3. On-Resistance Variation with Temperature

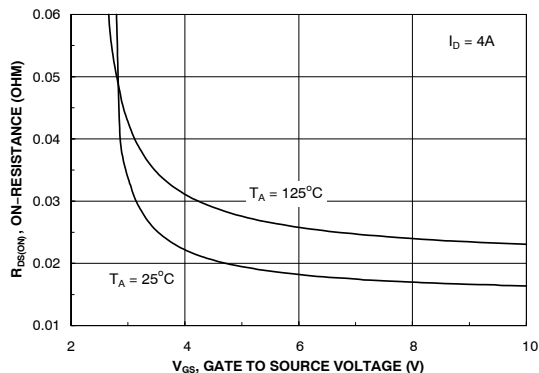

Figure 4. On-Resistance Variation with Gate-to-Source Voltage

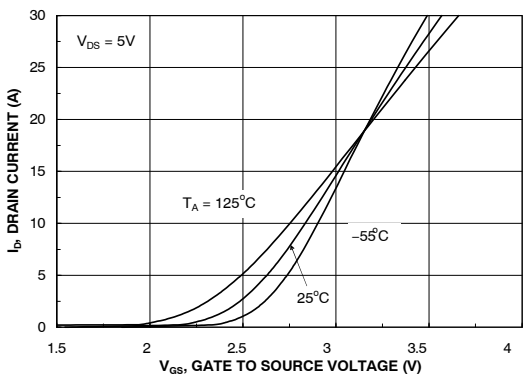

Figure 5. Transfer Characteristics

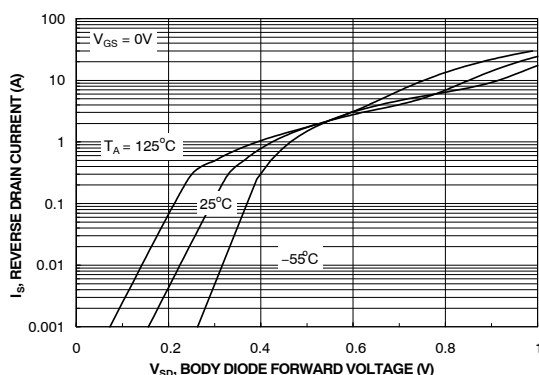

Figure 6. Body Diode Forward Voltage Variation with Source Current and Temperature

FDS6900AS, FDS6900AS-G

TYPICAL CHARACTERISTICS: Q2 (Continued)

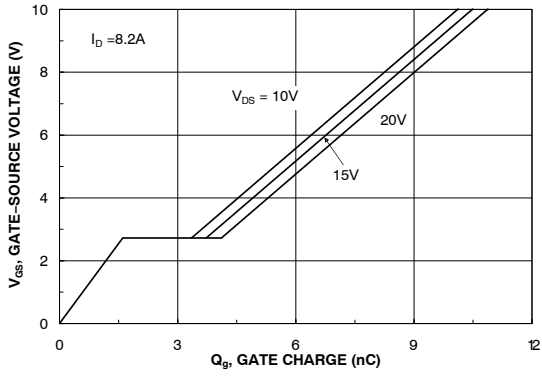

Figure 7. Gate Charge Characteristics

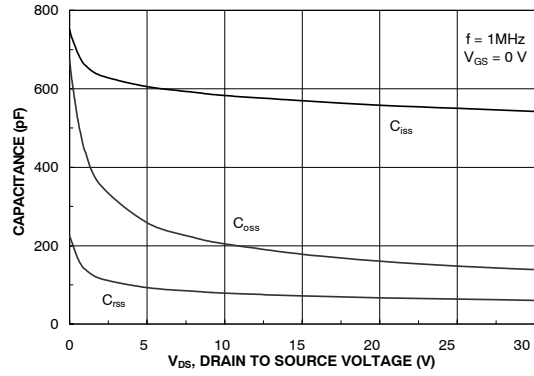

Figure 8. Capacitance Characteristics

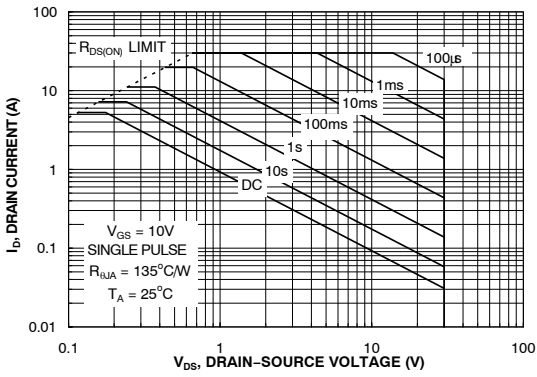

Figure 9. Maximum Safe Operating Area

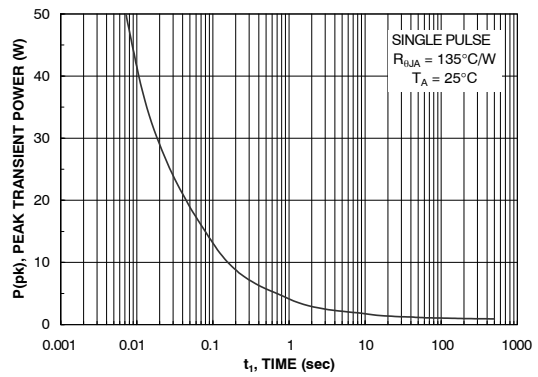

Figure 10. Single Pulse Maximum Power Dissipation

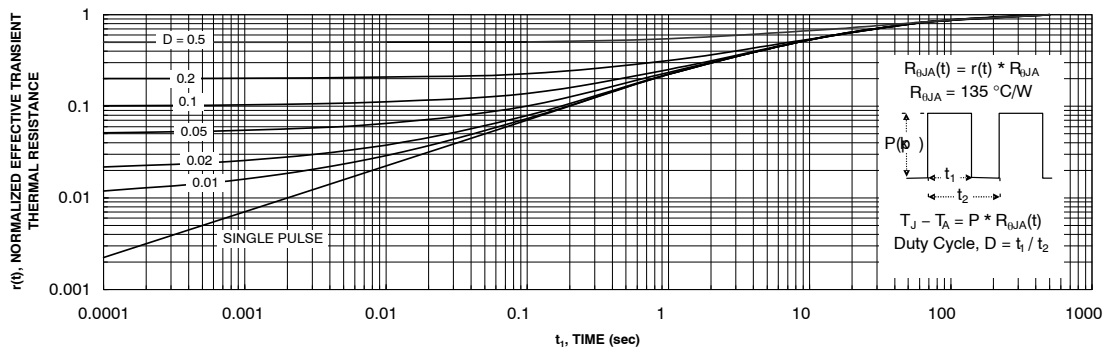

Figure 11. Transient Thermal Response Curve

Thermal characterization performed using the conditions described in Note 1c.
Transient thermal response will change depending on the circuit board design.

TYPICAL CHARACTERISTICS: Q1

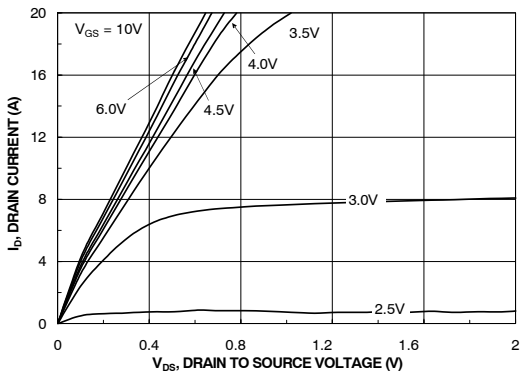

Figure 12. On-Region Characteristics

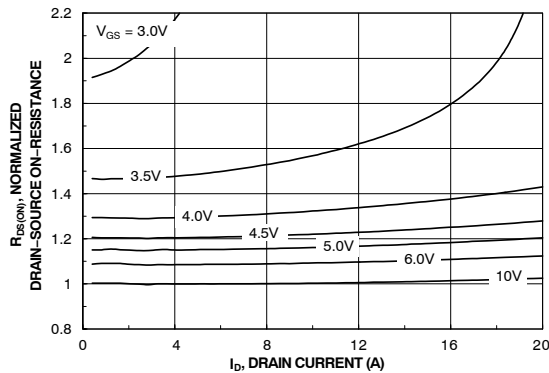

Figure 13. On-Resistance Variation with Drain Current and Gate Voltage

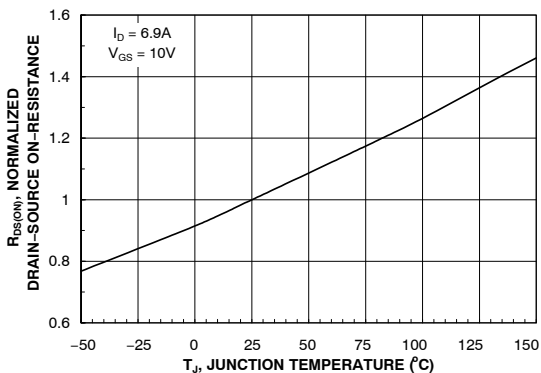

Figure 14. On-Resistance Variation with Temperature

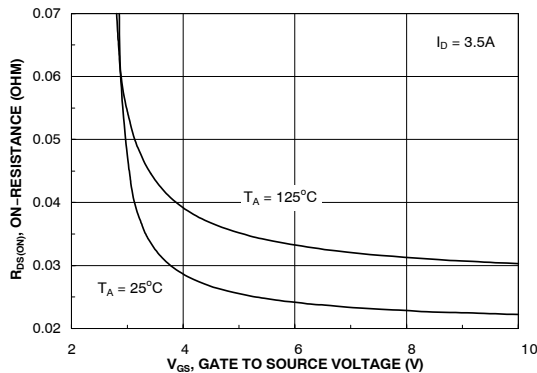

Figure 15. On-Resistance Variation with Gate-to-Source Voltage

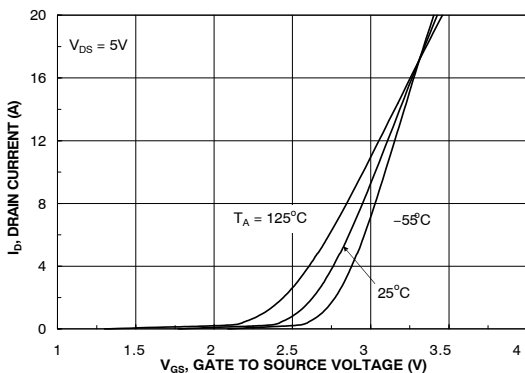

Figure 16. Transfer Characteristics

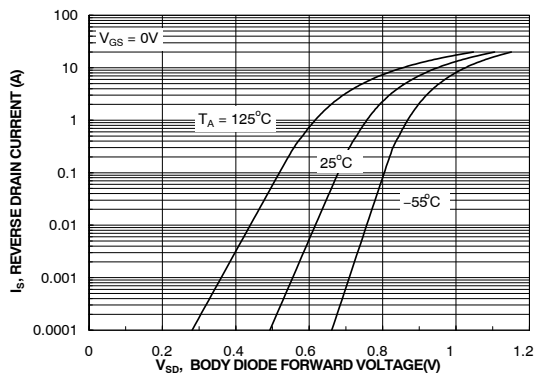

Figure 17. Body Diode Forward Voltage Variation with Source Current and Temperature

FDS6900AS, FDS6900AS-G

TYPICAL CHARACTERISTICS: Q1 (Continued)

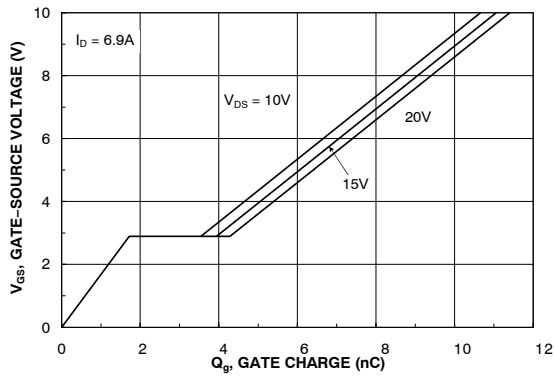

Figure 18. Gate Charge Characteristics

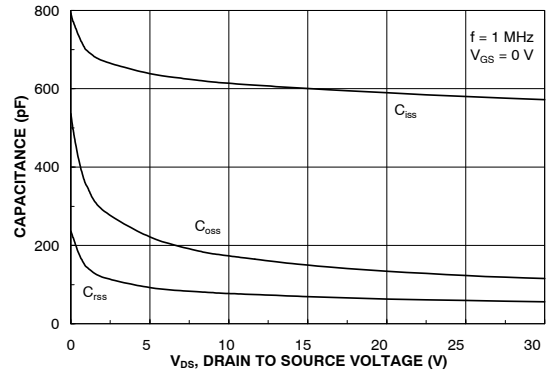

Figure 19. Capacitance Characteristics

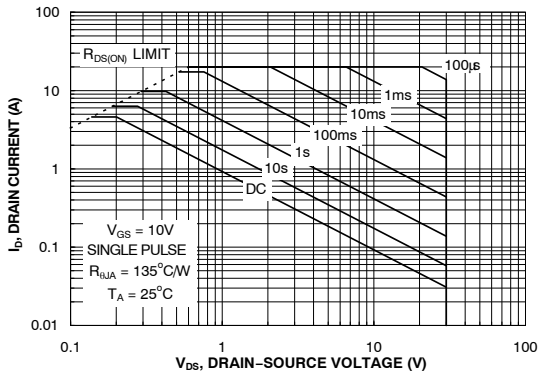

Figure 20. Maximum Safe Operating Area

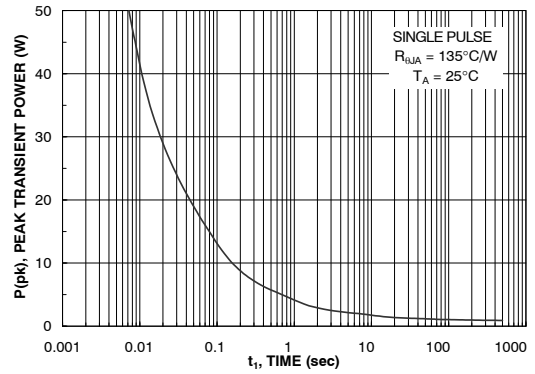

Figure 21. Single Pulse Maximum Power Dissipation

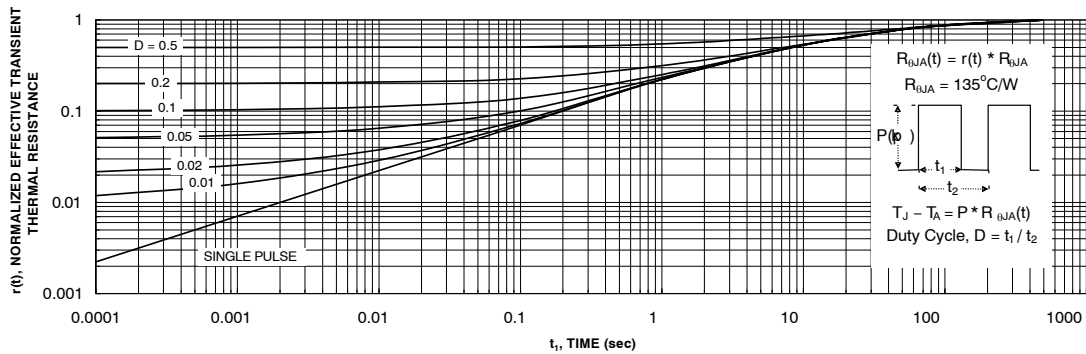

Figure 22. Transient Thermal Response Curve

Thermal characterization performed using the conditions described in Note 1c.
Transient thermal response will change depending on the circuit board design.

TYPICAL CHARACTERISTICS (Continued)

SyncFET Schottky Body Diode Characteristics

onsemi's SyncFET process embeds a Schottky diode in parallel with PowerTrench MOSFET. This diode exhibits similar characteristics to a discrete external Schottky diode in parallel with a MOSFET. Figure 23 shows the reverse recovery characteristic of the FDS6900AS.

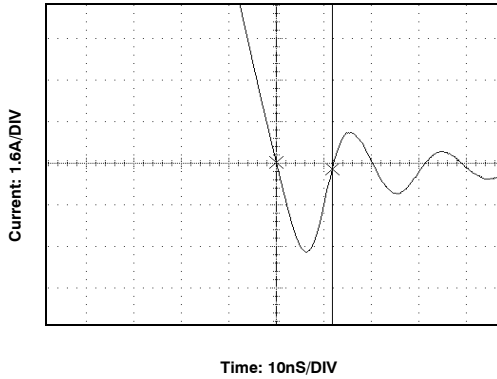

Figure 23. FDS6900AS SyncFET Body Diode Reverse Recovery Characteristics

For comparison purposes, Figure 24 shows the reverse recovery characteristics of the body diode of an equivalent size MOSFET produced without SyncFET (FDS6690).

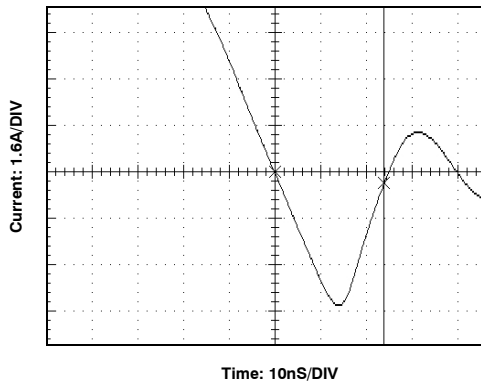

Figure 24. Non-SyncFET (FDS6690) Body Diode Reverse Recovery Characteristics

Schottky barrier diodes exhibit significant leakage at high temperature and high reverse voltage. This will increase the power in the device.

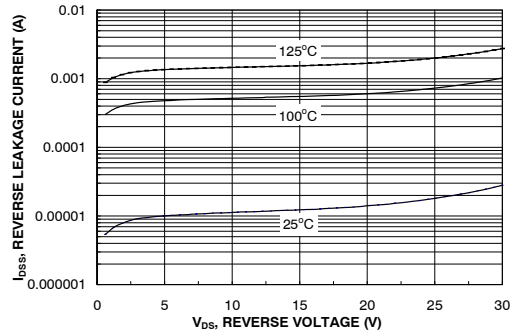

Figure 25. SyncFET Body Diode Reverse Leakage versus Drain-Source Voltage and Temperature

TYPICAL CHARACTERISTICS (Continued)

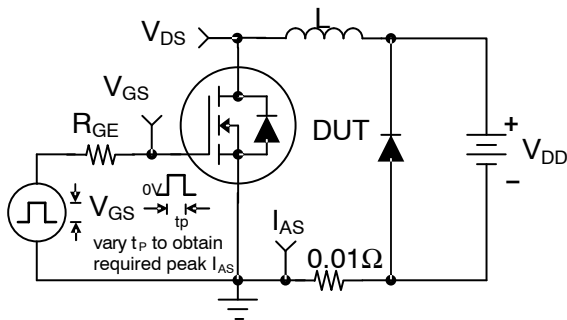

Figure 26. Unclamped Inductive Load Test Circuit

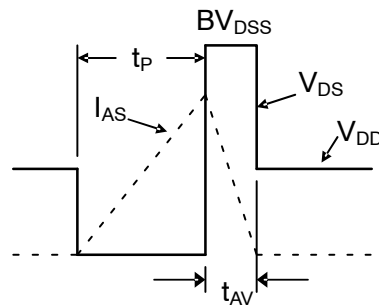

Figure 27. Unclamped Inductive Waveforms

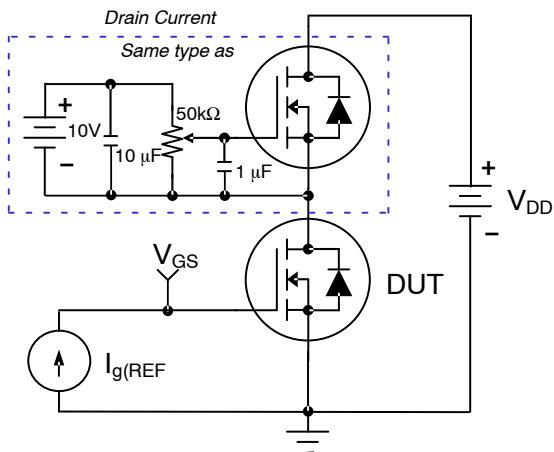

Figure 28. Gate Charge Test Circuit

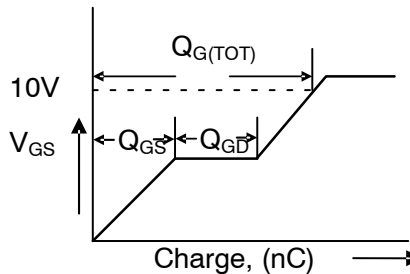

Figure 29. Gate Charge Waveform

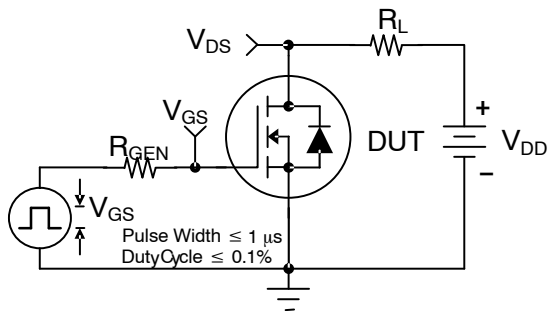

Figure 30. Switching Time Test Circuit

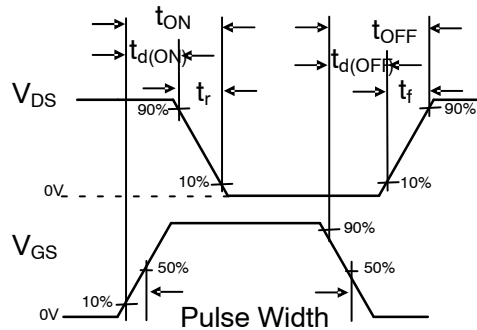

Figure 31. Switching Time Waveform

POWERTRENCH is a registered trademark and SyncFET is a trademark of Semiconductor Components Industries, LLC dba "onsemi" or its affiliates and/or subsidiaries in the United States and/or other countries.

MECHANICAL CASE OUTLINE
PACKAGE DIMENSIONS

ON Semiconductor®



SOIC8
CASE 751EB
ISSUE A

DATE 24 AUG 2017

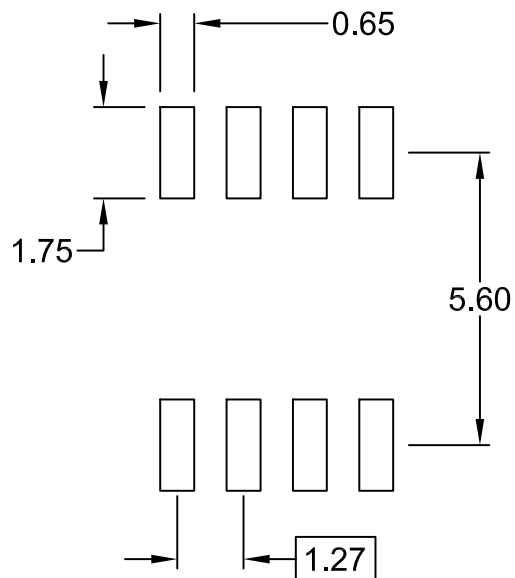
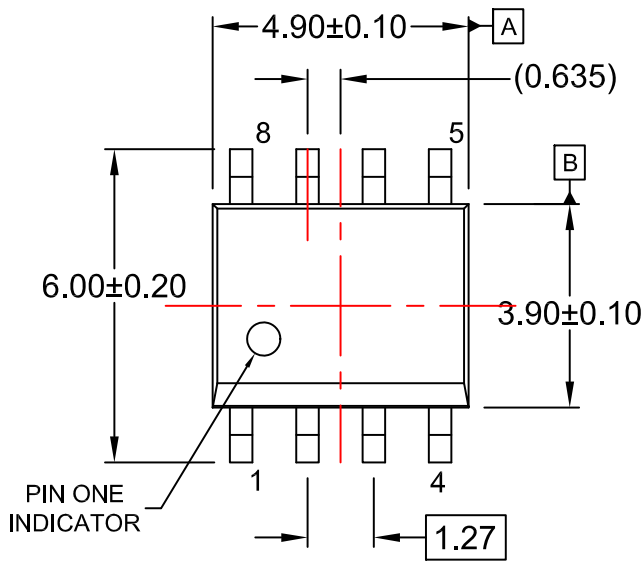

⊕ 0.25 (M) C B A

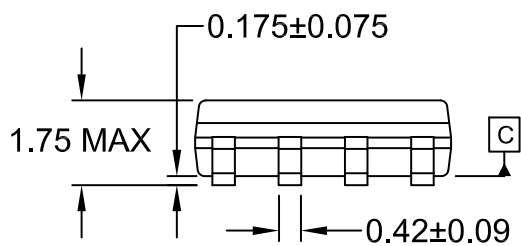

⌒ 0.10

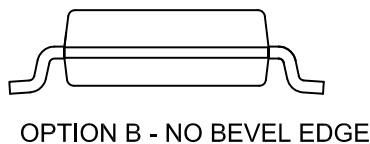
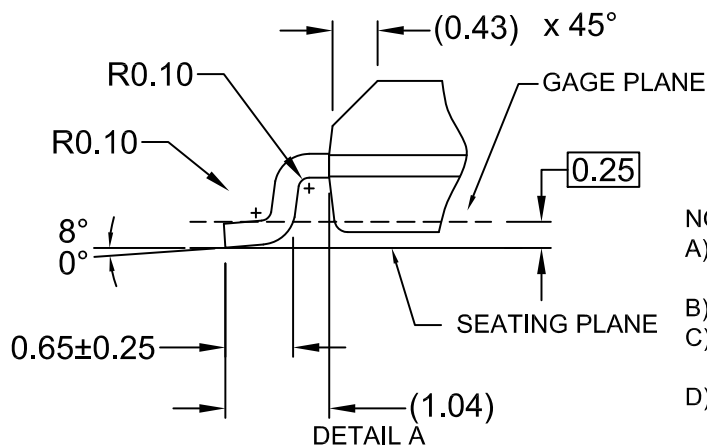
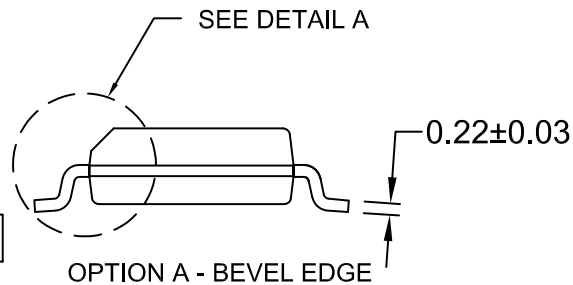

NOTES:

- A) THIS PACKAGE CONFORMS TO JEDEC MS-012, VARIATION AA.
- B) ALL DIMENSIONS ARE IN MILLIMETERS.
- C) DIMENSIONS DO NOT INCLUDE MOLD FLASH OR BURRS.
- D) LANDPATTERN STANDARD: SOIC127P600X175-8M

DOCUMENT NUMBER:	98AON13735G	Electronic versions are uncontrolled except when accessed directly from the Document Repository. Printed versions are uncontrolled except when stamped "CONTROLLED COPY" in red.
DESCRIPTION:	SOIC8	PAGE 1 OF 1

ON Semiconductor and ON are trademarks of Semiconductor Components Industries, LLC dba ON Semiconductor or its subsidiaries in the United States and/or other countries. ON Semiconductor reserves the right to make changes without further notice to any products herein. ON Semiconductor makes no warranty, representation or guarantee regarding the suitability of its products for any particular purpose, nor does ON Semiconductor assume any liability arising out of the application or use of any product or circuit, and specifically disclaims any and all liability, including without limitation special, consequential or incidental damages. ON Semiconductor does not convey any license under its patent rights nor the rights of others.

onsemi, **Onsemi**, and other names, marks, and brands are registered and/or common law trademarks of Semiconductor Components Industries, LLC dba "**onsemi**" or its affiliates and/or subsidiaries in the United States and/or other countries. **onsemi** owns the rights to a number of patents, trademarks, copyrights, trade secrets, and other intellectual property. A listing of **onsemi**'s product/patent coverage may be accessed at www.onsemi.com/site/pdf/Patent-Marking.pdf. **onsemi** reserves the right to make changes at any time to any products or information herein, without notice. The information herein is provided "as-is" and **onsemi** makes no warranty, representation or guarantee regarding the accuracy of the information, product features, availability, functionality, or suitability of its products for any particular purpose, nor does **onsemi** assume any liability arising out of the application or use of any product or circuit, and specifically disclaims any and all liability, including without limitation special, consequential or incidental damages. Buyer is responsible for its products and applications using **onsemi** products, including compliance with all laws, regulations and safety requirements or standards, regardless of any support or applications information provided by **onsemi**. "Typical" parameters which may be provided in **onsemi** data sheets and/or specifications can and do vary in different applications and actual performance may vary over time. All operating parameters, including "Typicals" must be validated for each customer application by customer's technical experts. **onsemi** does not convey any license under any of its intellectual property rights nor the rights of others. **onsemi** products are not designed, intended, or authorized for use as a critical component in life support systems or any FDA Class 3 medical devices or medical devices with a same or similar classification in a foreign jurisdiction or any devices intended for implantation in the human body. Should Buyer purchase or use **onsemi** products for any such unintended or unauthorized application, Buyer shall indemnify and hold **onsemi** and its officers, employees, subsidiaries, affiliates, and distributors harmless against all claims, costs, damages, and expenses, and reasonable attorney fees arising out of, directly or indirectly, any claim of personal injury or death associated with such unintended or unauthorized use, even if such claim alleges that **onsemi** was negligent regarding the design or manufacture of the part. **onsemi** is an Equal Opportunity/Affirmative Action Employer. This literature is subject to all applicable copyright laws and is not for resale in any manner.

ADDITIONAL INFORMATION

TECHNICAL PUBLICATIONS:

Technical Library: www.onsemi.com/design/resources/technical-documentation
onsemi Website: www.onsemi.com

ONLINE SUPPORT: www.onsemi.com/support

For additional information, please contact your local Sales Representative at www.onsemi.com/support/sales

