

MOSFET – N-Channel Shielded Gate POWERTRENCH®

150 V, 2 A, 236 mΩ

FDT86246

Description

This N-Channel MOSFET is produced using Fairchild onsemi advanced PowerTrench® Process that has been optimized for $R_{DS(on)}$, switching performance and ruggedness.

Features

- Max $R_{DS(on)}$ = 236 mΩ at $V_{GS} = 10\text{ V}$, $I_D = 2\text{ A}$
- Max $R_{DS(on)}$ = 329 mΩ at $V_{GS} = 6\text{ V}$, $I_D = 1.7\text{ A}$
- High Performance Trench Technology for Extremely Low $R_{DS(on)}$
- High Power and Current Handling Capability in a Widely Used Surface Mount Package
- Fast Switching Speed
- 100% UIL Tested
- These Devices are Pb-Free and are RoHS Compliant

Typical Applications

- Load Switch
- Primary Switch

MOSFET Maximum Ratings $T_A = 25^\circ\text{C}$ unless otherwise noted

Symbol	Parameter	Ratings	Unit
V_{DS}	Drain to Source Voltage	150	V
V_{GS}	Gate to Source Voltage	± 20	V
I_D	Drain Current –Continuous (Note 1a)	2	A
	–Pulsed	8	
E_{AS}	Single Pulse Avalanche Energy (Note 3)	8	mJ
P_D	Power Dissipation (Note 1a)	2.2	W
	Power Dissipation (Note 1b)	1.0	
T_J, T_{STG}	Operating and Storage Junction Temperature Range	-55 to +150	$^\circ\text{C}$

Stresses exceeding those listed in the Maximum Ratings table may damage the device. If any of these limits are exceeded, device functionality should not be assumed, damage may occur and reliability may be affected.

THERMAL CHARACTERISTICS

Symbol	Parameter	Value	Unit
$R_{\theta JC}$	Thermal Resistance, Junction to Case (Note 1)	12	$^\circ\text{C}/\text{W}$
$R_{\theta JA}$	Thermal Resistance, Junction to Ambient (Note 1a)	55	

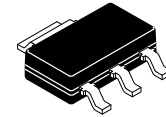

SOT-223
CASE 318H

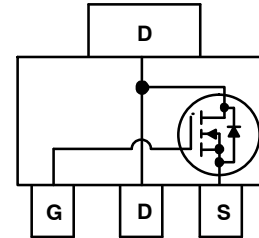

MARKING DIAGRAM

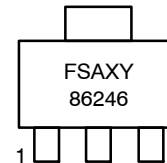

Z = Assembly Plan Code
XY = Date Code (Year & week)
86246 = Specific Device Code

ORDERING INFORMATION

Device	Package	Shipping†
FDT86246	SOT-223 (Pb-Free)	4000 / Tape & Reel

†For information on tape and reel specifications, including part orientation and tape sizes, please refer to our Tape and Reel Packaging Specifications Brochure, [BRD8011/D](#).

FDT86246

ELECTRICAL CHARACTERISTICS $T_A = 25^\circ\text{C}$ unless otherwise noted

Symbol	Parameter	Test Conditions	Min	Typ	Max	Unit
Off Characteristics						
BV_{DSS}	Drain to Source Breakdown Voltage	$I_D = 250 \mu\text{A}$, $V_{GS} = 0 \text{ V}$	150	–	–	V
$\frac{\Delta BV_{DSS(th)}}{\Delta T_J}$	Breakdown Voltage Temperature Coefficient	$I_D = 250 \mu\text{A}$, referenced to 25°C	–	104	–	$\text{mV}/^\circ\text{C}$
I_{DSS}	Zero Gate Voltage Drain Current	$V_{DS} = 120 \text{ V}$, $V_{GS} = 0 \text{ V}$	–	–	1	μA
I_{GSS}	Gate to Source Leakage Current	$V_{GS} = \pm 20 \text{ V}$, $V_{DS} = 0 \text{ V}$	–	–	± 100	nA
On Characteristics						
$V_{GS(th)}$	Gate to Source Threshold Voltage	$V_{GS} = V_{DS}$, $I_D = 250 \mu\text{A}$	2.0	3.1	4.0	V
$\frac{\Delta V_{GS(th)}}{\Delta T_J}$	Gate to Source Threshold Voltage Temperature Coefficient	$I_D = 250 \mu\text{A}$, referenced to 25°C	–	–9	–	$\text{mV}/^\circ\text{C}$
$R_{DS(on)}$	Static Drain to Source On Resistance	$V_{GS} = 10 \text{ V}$, $I_D = 2 \text{ A}$	–	194	236	m Ω
		$V_{GS} = 6 \text{ V}$, $I_D = 1.7 \text{ A}$	–	231	329	
		$V_{GS} = 10 \text{ V}$, $I_D = 2 \text{ A}$, $T_J = 125^\circ\text{C}$	–	349	425	
g_{FS}	Forward Transconductance	$V_{DS} = 10 \text{ V}$, $I_D = 2 \text{ A}$	–	5	–	S
Dynamic Characteristics						
C_{iss}	Input Capacitance	$V_{DS} = 75 \text{ V}$, $V_{GS} = 0 \text{ V}$, $f = 1 \text{ MHz}$	–	161	215	pF
C_{oss}	Output Capacitance		–	21	30	pF
C_{rss}	Reverse Transfer Capacitance		–	1.6	5	pF
R_g	Gate Resistance		–	0.9	–	Ω
Switching Characteristics						
$t_{d(on)}$	Turn-On Delay Time	$V_{DD} = 75 \text{ V}$, $I_D = 2 \text{ A}$, $V_{GS} = 10 \text{ V}$, $R_{GEN} = 6 \Omega$	–	7.8	16	ns
t_r	Rise Time		–	2.3	10	ns
$t_{d(off)}$	Turn-Off Delay Time		–	4.6	10	ns
t_f	Fall Time		–	1.2	10	ns
$Q_{g(TOT)}$	Total Gate Charge	$V_{GS} = 0 \text{ V to } 10 \text{ V}$, $V_{GS} = 0 \text{ V to } 5 \text{ V}$	–	2.9	4	nC
$Q_{g(TOT)}$	Total Gate Charge		–	1.7	3	–
Q_{gs}	Total Gate Charge	$V_{DD} = 75 \text{ V}$, $I_D = 2 \text{ A}$	–	0.9	–	nC
Q_{gd}	Gate to Drain "Miller" Charge		–	0.8	–	nC

FDT86246

ELECTRICAL CHARACTERISTICS (continued) $T_A = 25^\circ\text{C}$ unless otherwise noted

Symbol	Parameter	Test Conditions	Min	Typ	Max	Unit
Drain-Source Diode Characteristics						
V_{SD}	Source to Drain Diode Forward Voltage	$V_{GS} = 0\text{ V}$, $I_S = 2\text{ A}$ (Note 2)	-	0.84	1.3	V
t_{rr}	Reverse Recovery Time	$I_F = 2\text{ A}$, $di/dt = 100\text{ A}/\mu\text{s}$	-	44	71	ns
Q_{rr}	Reverse Recovery Charge		-	31	49	nC

Product parametric performance is indicated in the Electrical Characteristics for the listed test conditions, unless otherwise noted. Product performance may not be indicated by the Electrical Characteristics if operated under different conditions.

NOTES:

- $R_{\theta JA}$ is determined with the device mounted on a 1 in² pad 2 oz copper pad on a 1.5 x 1.5 in. board of FR-4 material. $R_{\theta JC}$ is guaranteed by design while $R_{\theta CA}$ is determined by the user's board design.

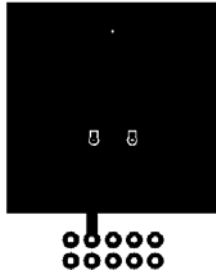

a) 55 °C/W when mounted on a 1 in² pad of 2 oz copper



b) 118 °C/W when mounted on a minimum pad of 2 oz copper

- Pulse Test : Pulse Width < 300 μs , Duty Cycle < 2.0%
- Starting $T_J = 25^\circ\text{C}$; N-ch: $L = 1.0\text{ mH}$, $I_{AS} = 4.0\text{ A}$, $V_{DD} = 135\text{ V}$, $V_{GS} = 10\text{ V}$.

TYPICAL CHARACTERISTICS $T_J = 25^\circ\text{C}$ UNLESS OTHERWISE NOTED

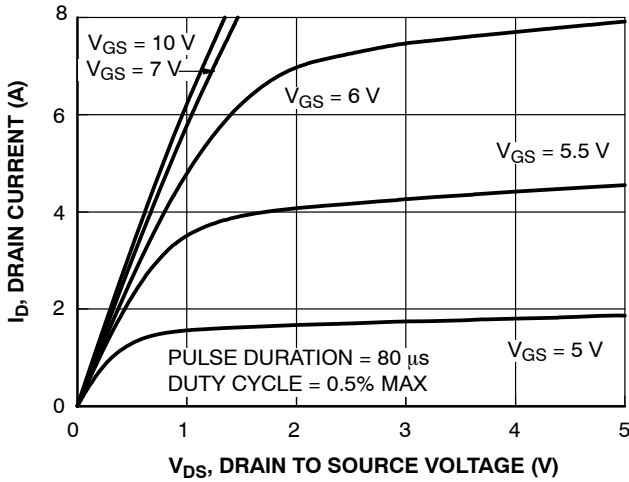

Figure 1. On-Region Characteristics

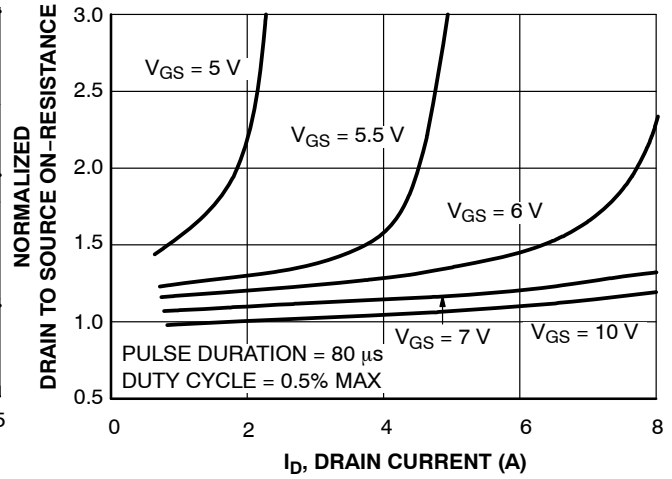

Figure 2. Normalized On-Resistance vs. Drain Current and Gate Voltage

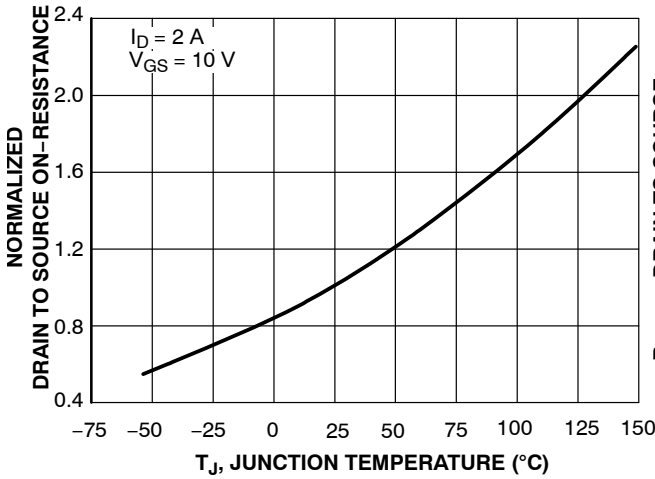

Figure 3. Normalized On Resistance vs. Junction Temperature

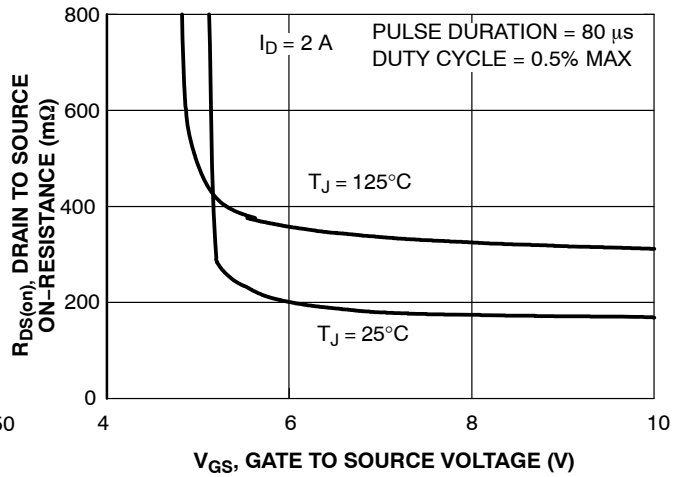

Figure 4. On-Resistance vs. Gate to Source Voltage

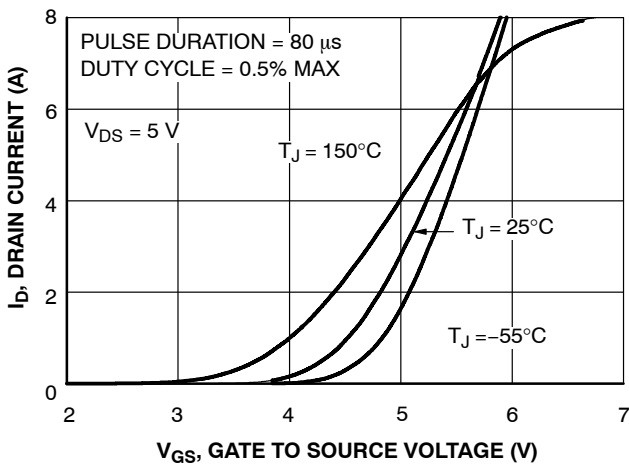

Figure 5. Transfer Characteristics

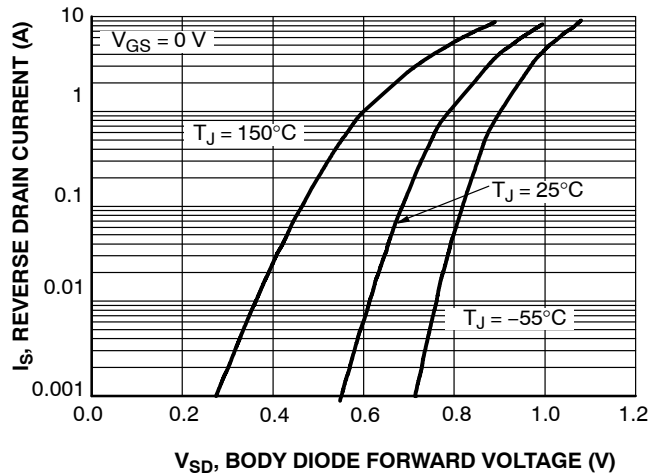

Figure 6. Source to Drain Diode Forward Voltage vs. Source Current

TYPICAL CHARACTERISTICS (CONTINUED) $T_J = 25^\circ\text{C}$ UNLESS OTHERWISE NOTED

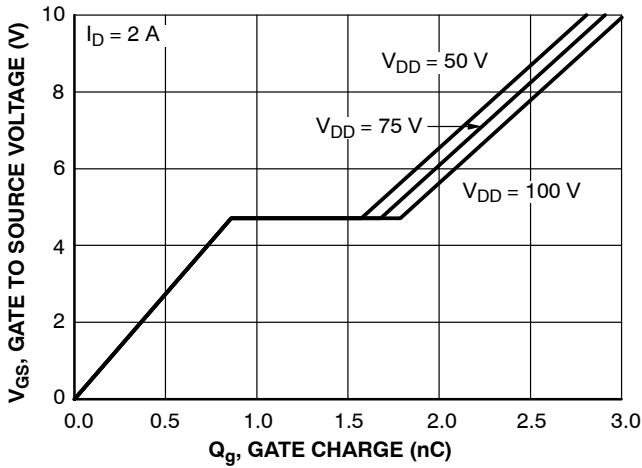

Figure 7. Gate Charge Characteristics

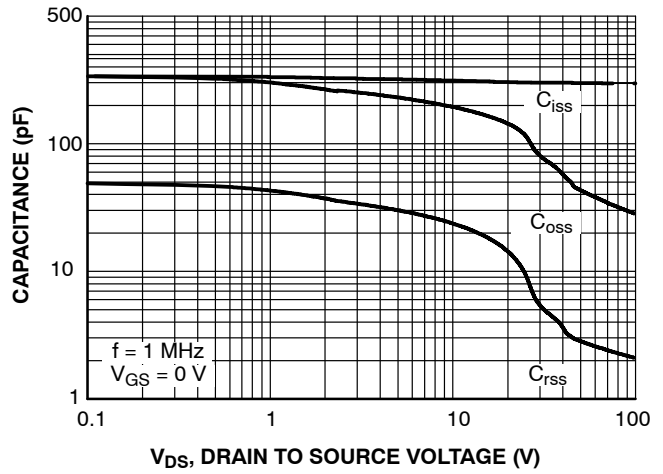

Figure 8. Capacitance vs Drain to Source Voltage

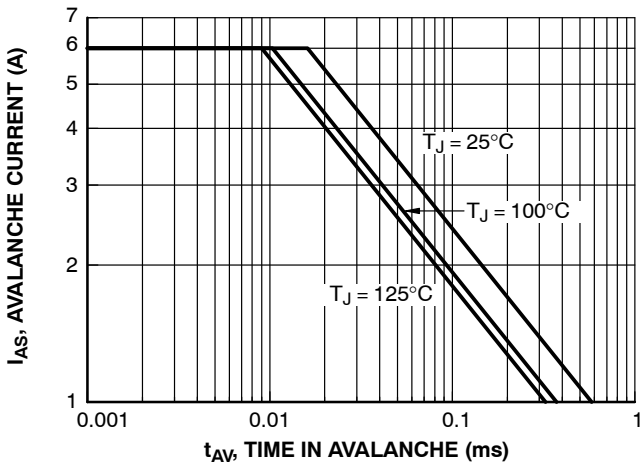

Figure 9. Unclamped Inductive Switching Capability

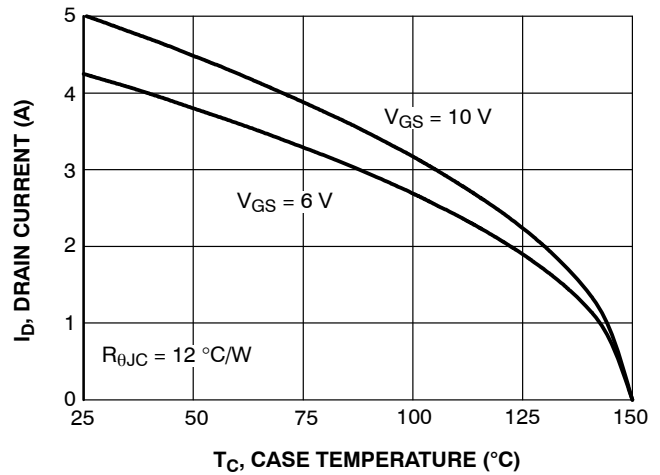

Figure 10. Maximum Continuous Drain Current vs Case Temperature

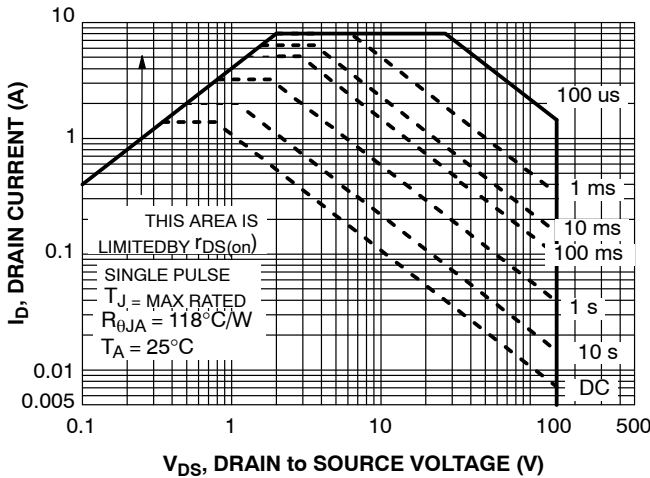

Figure 11. Forward Bias Safe Operating Area

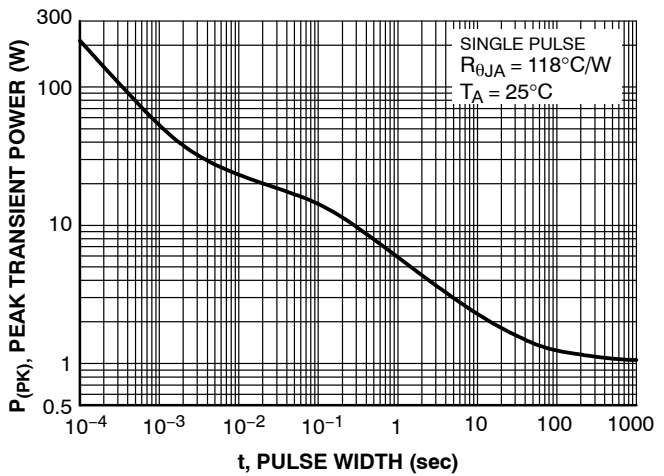

Figure 12. Single Pulse Maximum Power Dissipation

TYPICAL CHARACTERISTICS (CONTINUED) $T_J = 25^\circ\text{C}$ UNLESS OTHERWISE NOTED

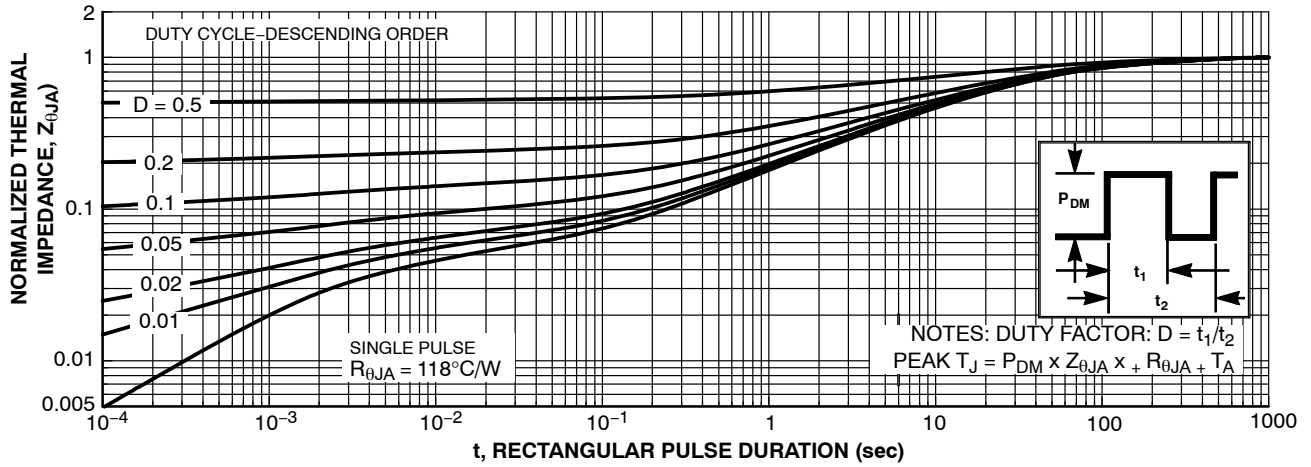
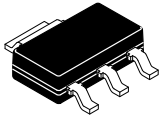

Figure 13. Junction-to-Ambient Transient Thermal Response Curve



SCALE 2:1

SOT-223
CASE 318H
ISSUE B

DATE 13 MAY 2020

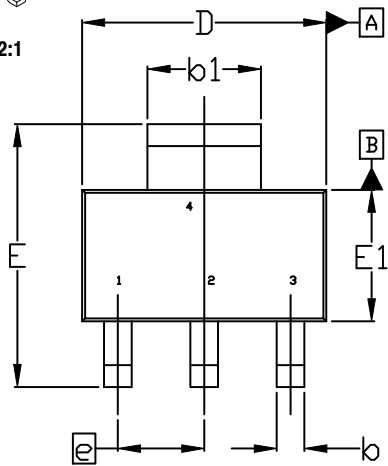

TOP VIEW

$\oplus 0.10 \text{ M C A B}$

NOTE 7

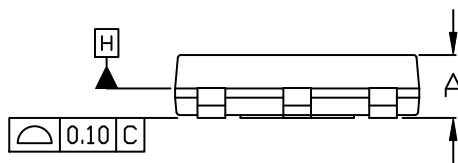

SIDE VIEW

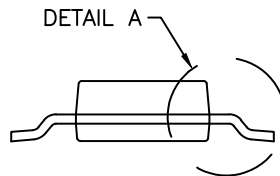

END VIEW

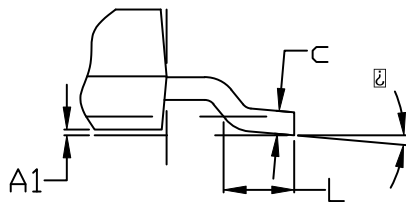

DETAIL A

NOTES:

1. DIMENSIONING AND TOLERANCING PER ASME Y14.5M, 2009.
2. CONTROLLING DIMENSION: MILLIMETERS
3. DIMENSIONS D & E1 ARE DETERMINED AT DATUM H. DIMENSIONS DO NOT INCLUDE MOLD FLASH, PROTRUSIONS OR GATE BURRS. SHALL NOT EXCEED 0.23mm PER SIDE.
4. LEAD DIMENSIONS b AND b1 DO NOT INCLUDE DAMBAR PROTRUSION. ALLOWABLE DAMBAR PROTRUSION IS 0.08mm PER SIDE.
5. DATUMS A AND B ARE DETERMINED AT DATUM H.
6. A1 IS DEFINED AS THE VERTICAL DISTANCE FROM THE SEATING PLANE TO THE LOWEST POINT OF THE PACKAGE BODY.
7. POSITIONAL TOLERANCE APPLIES TO DIMENSIONS b AND b1.

DIM	MILLIMETERS		
	MIN.	NOM.	MAX.
A	---	---	1.80
A1	0.02	0.06	0.11
b	0.60	0.74	0.88
b1	2.90	3.00	3.10
c	0.24	---	0.35
D	6.30	6.50	6.70
E	6.70	7.00	7.30
E1	3.30	3.50	3.70
e	2.30 BSC		
L	0.25	---	---
\square	0°	---	10°

GENERIC MARKING DIAGRAM*

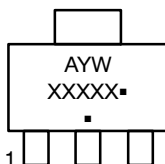

- A = Assembly Location
- Y = Year
- W = Work Week
- XXXXX = Specific Device Code
- = Pb-Free Package

(Note: Microdot may be in either location)

*This information is generic. Please refer to device data sheet for actual part marking. Pb-Free indicator, "G" or microdot "▪", may or may not be present. Some products may not follow the Generic Marking.

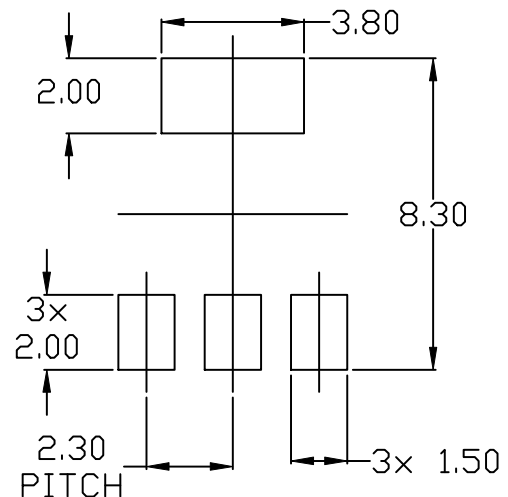

RECOMMENDED MOUNTING FOOTPRINT

* For additional information on our Pb-Free strategy and soldering details, please download the ON Semiconductor Soldering and Mounting Techniques Reference Manual, SOLDERM/D.

DOCUMENT NUMBER:	98ASH70634A	Electronic versions are uncontrolled except when accessed directly from the Document Repository. Printed versions are uncontrolled except when stamped "CONTROLLED COPY" in red.
DESCRIPTION:	SOT-223	PAGE 1 OF 1

onsemi and ONSEMI are trademarks of Semiconductor Components Industries, LLC dba onsemi or its subsidiaries in the United States and/or other countries. onsemi reserves the right to make changes without further notice to any products herein. onsemi makes no warranty, representation or guarantee regarding the suitability of its products for any particular purpose, nor does onsemi assume any liability arising out of the application or use of any product or circuit, and specifically disclaims any and all liability, including without limitation special, consequential or incidental damages. onsemi does not convey any license under its patent rights nor the rights of others.

onsemi, **Onsemi**, and other names, marks, and brands are registered and/or common law trademarks of Semiconductor Components Industries, LLC dba "**onsemi**" or its affiliates and/or subsidiaries in the United States and/or other countries. **onsemi** owns the rights to a number of patents, trademarks, copyrights, trade secrets, and other intellectual property. A listing of **onsemi**'s product/patent coverage may be accessed at www.onsemi.com/site/pdf/Patent-Marking.pdf. **onsemi** reserves the right to make changes at any time to any products or information herein, without notice. The information herein is provided "as-is" and **onsemi** makes no warranty, representation or guarantee regarding the accuracy of the information, product features, availability, functionality, or suitability of its products for any particular purpose, nor does **onsemi** assume any liability arising out of the application or use of any product or circuit, and specifically disclaims any and all liability, including without limitation special, consequential or incidental damages. Buyer is responsible for its products and applications using **onsemi** products, including compliance with all laws, regulations and safety requirements or standards, regardless of any support or applications information provided by **onsemi**. "Typical" parameters which may be provided in **onsemi** data sheets and/or specifications can and do vary in different applications and actual performance may vary over time. All operating parameters, including "Typicals" must be validated for each customer application by customer's technical experts. **onsemi** does not convey any license under any of its intellectual property rights nor the rights of others. **onsemi** products are not designed, intended, or authorized for use as a critical component in life support systems or any FDA Class 3 medical devices or medical devices with a same or similar classification in a foreign jurisdiction or any devices intended for implantation in the human body. Should Buyer purchase or use **onsemi** products for any such unintended or unauthorized application, Buyer shall indemnify and hold **onsemi** and its officers, employees, subsidiaries, affiliates, and distributors harmless against all claims, costs, damages, and expenses, and reasonable attorney fees arising out of, directly or indirectly, any claim of personal injury or death associated with such unintended or unauthorized use, even if such claim alleges that **onsemi** was negligent regarding the design or manufacture of the part. **onsemi** is an Equal Opportunity/Affirmative Action Employer. This literature is subject to all applicable copyright laws and is not for resale in any manner.

ADDITIONAL INFORMATION

TECHNICAL PUBLICATIONS:

Technical Library: www.onsemi.com/design/resources/technical-documentation
onsemi Website: www.onsemi.com

ONLINE SUPPORT: www.onsemi.com/support

For additional information, please contact your local Sales Representative at www.onsemi.com/support/sales