



The Future of Analog IC Technology®

HF920

900V, Fixed-Frequency, Offline Regulator w/ Ultra-Low Standby Power Consumption

DESCRIPTION

The HF920 is a flyback regulator with a monolithic, 900V MOSFET. The HF920 provides excellent power regulation in AC/DC applications that require high reliability, such as smart meters, large appliances, industrial controls, and products powered by poor AC grids. The HF920 requires a minimal number of external components.

The HF920 uses peak-current-mode control to provide excellent transient response and easy loop compensation. When the output power falls below a given level, the regulator enters burst mode. The IC consumption is also specially optimized. As a result, the HF920 achieves very low power consumption during standby conditions.

MPS's proprietary, 900V, monolithic process enables an over-temperature protection (OTP) that is on the same silicon as the 900V power MOSFET, offering the most precise thermal protection. The HF920 also offers a full suite of protection features such as VCC under-voltage lockout (UVLO), overload protection (OLP), over-voltage protection (OVP), and short-circuit protection (SCP).

The HF920 is designed to minimize electromagnetic interference for power line communications (PLC) in home and building automation applications. The operating frequency is programmed externally with a single resistor, so the power supply's radiated energy can be designed to block interference to the PLC. In addition to the programmable frequency, the HF920 employs frequency jittering that reduces the noise level and EMI filter cost greatly.

Frequency-doubling mode operation can be enabled through a simple external set-up. With this special operation mode, the switching frequency is doubled when the converter runs into an over-power condition. In this way, the converter is able to handle up to a 50% decrease of the transformer inductance caused by external magnetizing interference.

FEATURES

- Monolithic 900V/15Ω MOSFET and High-Voltage Current Source
- Fixed Switching Frequency, Programmable up to 150kHz
- Current-Mode Control Scheme
- Frequency Jittering
- Low Standby Power Consumption via Active Burst Mode
- <30mW No-Load Consumption
- Frequency Doubling Operation Mode
- Internal Leading-Edge Blanking (LEB)
- Built-In Soft-Start (SS) Function
- Internal Slope Compensation
- External Input PRO Pin Protection with Hysteresis and Auto-Restart Recovery
- Over-Temperature Protection (OTP)
- VCC Under-Voltage Lockout (UVLO) with Hysteresis
- Over-Voltage Protection (OVP) on VCC
- Time-Based Overload Protection (OLP)
- Short-Circuit Protection (SCP)
- Available in SOIC8-7A and SOIC14-11 Packages

APPLICATIONS

- E-Meters
- Industrial Controls
- Large Appliances

All MPS parts are lead-free, halogen-free, and adhere to the RoHS directive. For MPS green status, please visit the MPS website under Quality Assurance. "MPS" and "The Future of Analog IC Technology" are registered trademarks of Monolithic Power Systems, Inc.

Table 1: Maximum Output Power

Package	P _{MAX} (W)	
	85Vac~420Vac	230Vac±15%
SOIC8-7A	6.5	9.5
SOIC14-11	7	10

NOTES:

- The maximum output power is limited by junction temperature.
- Test is done under T_A = 50°C. The test board is placed into a box about 20cm*15cm*10cm.
- To reduce V_{DS}, the turns ratio is set to 5.
- Single output, V_{OUT} = 12.5V.
- GND of the SOIC8-7A package is connected to a 3cm² copper area with exposed copper strips. GND of the SOIC14-11 package is connected to a 2.5cm² copper area.
- Working condition under minimum input voltage is set to BCM.

TYPICAL APPLICATION

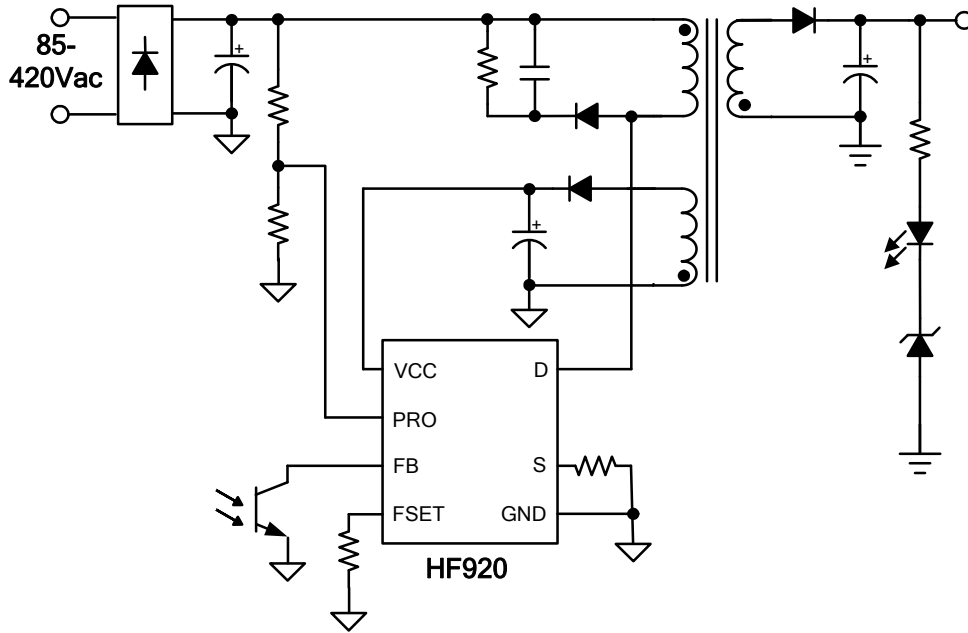

ORDERING INFORMATION

Part Number	Package	Top Marking
HF920GSE*	SOIC8-7A	<i>See Below</i>
HF920GS**	SOIC14-11	<i>See Below</i>

* For Tape & Reel, add suffix -Z (e.g.: HF920GSE-Z)

** For Tape & Reel, add suffix -Z (e.g.: HF920GS-Z)

TOP MARKING (HF920GSE)

HF920
LLLLLLLLL
MPSYWW

HF920: Part number
LLLLLLLLL: Lot number
MPS: MPS prefix
Y: Year code
WW: Week code

TOP MARKING (HF920GS)

MPSYYWW
HF920
LLLLLLLLL

MPS: MPS prefix
YY: Year code
WW: Week code
HF920: Part number
LLLLLLLLL: Lot number

PACKAGE REFERENCE

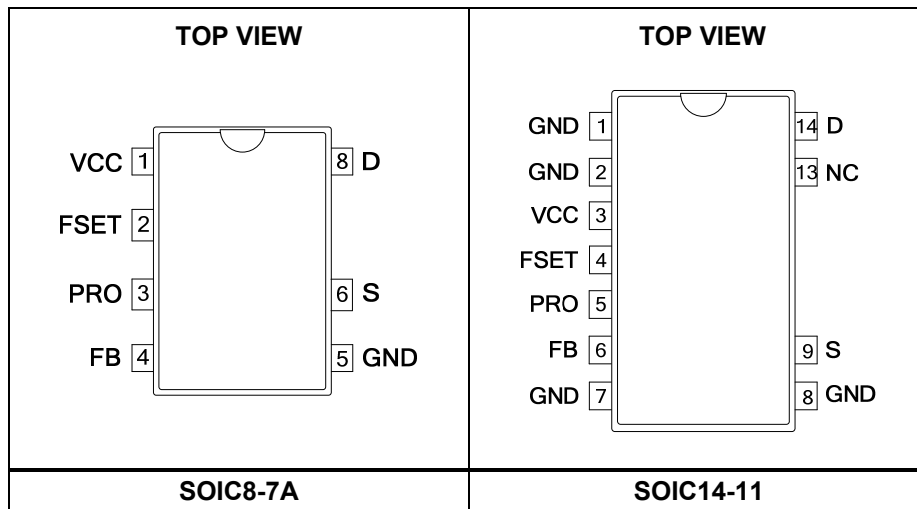

ABSOLUTE MAXIMUM RATINGS ⁽¹⁾

D	-0.3V to 900V
VCC	-0.3V to 30V
All other pins	-0.3V to 6.5V
Continuous power dissipation (T_A = +25°C) ⁽²⁾	
SOIC8-7A	1.3W
SOIC14-11	1.78W
Junction temperature	150°C
Lead temperature	260°C
Storage temperature	-60°C to +150°C
ESD capability human body model	2.0kV
ESD capability charged device model	2.0kV

Recommended Operation Conditions ⁽³⁾

VCC to GND	10V to 24V
Operating junction temp. (T _J)	-40°C to +125°C

Thermal Resistance ⁽⁴⁾	θ_{JA}	θ_{JC}	
SOIC8-7A	96	45	°C/W
SOIC14-11	70	35	°C/W

NOTES:

- 1) Exceeding these ratings may damage the device.
- 2) The maximum allowable power dissipation is a function of the maximum junction temperature T_J (MAX), the junction-to-ambient thermal resistance θ_{JA}, and the ambient temperature T_A. The maximum allowable continuous power dissipation at any ambient temperature is calculated by P_D (MAX) = (T_J (MAX) - T_A) / θ_{JA}. Exceeding the maximum allowable power dissipation produces an excessive die temperature, causing the regulator to go into thermal shutdown. Internal thermal shutdown circuitry protects the device from permanent damage.
- 3) The device is not guaranteed to function outside of its operating conditions.
- 4) Measured on JESD51-7, 4-layer PCB.

ELECTRICAL CHARACTERISTICS

VCC = 12V, T_J = -40°C to 125°C, min and max values are guaranteed by characterization, typical values are tested under 25°C, unless otherwise noted.

Parameter	Symbol	Conditions	Min	Typ	Max	Unit	
Start-Up Current Source and Internal MOSFET (D Pin)							
Supply current from drain	I _{Charge}	VCC = V _{CCH} - 0.1V, V _D = 400V	1	2	3	mA	
Leakage current from drain	I _{Leak}	V _D = 400V, V _{GS} = 0V, T _J = 25°C			1	μA	
		V _D = 400V, V _{GS} = 0V			10		
Breakdown voltage	V _{(BR)DSS}		900			V	
On-state resistance	R _{DS(ON)}	VCC = 10V, I _D = 100mA		T _J = 25°C	15	18	Ω
				T _J = 125°C	25	29	Ω
Supply Voltage Management (VCC Pin)							
VCC upper level at which the IC switch turns on	V _{CCH}		12	13	14	V	
VCC lower level at which the IC switch turns off	V _{CCL}		8.4	9	9.6	V	
VCC hysteresis	V _{CC_HYS}		3	4	5	V	
VCC OVP level	V _{OVP}		24.4	25.5	26.5	V	
VCC OVP delay time	t _{OVP}			70		μs	
VCC recharge level after protections	V _{CCR}		4.8	5.5	6.2	V	
Quiescent current during protections	I _{Pro}	VCC = V _{CCL}			300	μA	
Quiescent current	I _Q	VCC = V _{CCH} - 0.1V		200	300	μA	
Operation current	I _{CC}	VCC = 13V, f _s = 100kHz		510	610	μA	
		VCC = 13V, FB = 0V		300	400	μA	
Feedback Management (FB Pin)							
Internal pull-up resistor	R _{FB}	Normal operating		39		kΩ	
Internal pull-up voltage	V _{UP}		4.1	4.4	4.7	V	
FB to current-set-point division ratio	K _{div}			3.4	3.7		
Internal soft-start time	t _{SS}			6.7		ms	
FB decreasing level at which the regulator enters burst mode	V _{BURL}		0.4	0.5	0.6	V	
FB increasing level at which the regulator leaves burst mode	V _{BURH}		0.6	0.7	0.8	V	
Overload set point	V _{OLP}		3.3	3.65	4	V	
Overload counter				8192			
Threshold for frequency to recover	V _{FR}	C _{FSET} = 1nF	2.85	3	3.15	V	
Frequency doubling entry/recovery counter		C _{FSET} = 1nF		31			
Frequency Setting (FSET Pin)							
FSET reference voltage	V _{FSET}		1.18	1.25	1.32	V	
Frequency spectrum jittering range, in percentage of F _s	R _{Jittering}			±3.5		%	
Typical operating frequency	f _s	R _{FSET} = 200kΩ	43	49	55	kHz	
		R _{FSET} = 200kΩ, C _{FSET} = 1nF, V _{FB} = 3.5V	87	99	111		
Maximum switching duty	D _{max}		79	83	87	%	

ELECTRICAL CHARACTERISTICS (continued)

VCC = 12V, T_J = -40°C to 125°C, min and max values are guaranteed by characterization, typical values are tested under 25°C, unless otherwise noted.

Parameter	Symbol	Conditions	Min	Typ	Max	Unit
Current Sensing Management (S Pin)						
Leading-edge blanking for current sensor	t _{LEB1}			385		ns
Leading-edge blanking for SCP	t _{LEB2}			350		ns
Maximum current set point	V _{CSL}		0.91	0.97	1.02	V
Short-circuit protection set point	V _{SCP}		1.43	1.5	1.57	V
Slope compensation ramp	S _{Ramp}	R _{FSET} = 200kΩ		21		mV/μs
Protection Management (PRO Pin)						
Protection voltage	V _{PRO}		2.92	3.1	3.32	V
Protection hysteresis	V _{PRO-Hys}			0.2		V
Thermal Shutdown						
Thermal shutdown threshold ⁽⁵⁾				150		°C
Thermal shutdown recovery hysteresis ⁽⁵⁾				30		°C

NOTE:

5) This parameter is guaranteed by design.

PIN FUNCTIONS

Pin #		Name	Description
SOIC8-7A	SOIC14-11		
1	3	VCC	IC power supply. Connect an electrolytic capacitor and a small ceramic decoupling capacitor to VCC.
2	4	FSET	Switching frequency setting. Connect a resistor from FSET to GND to set the switching frequency, which can be up to 150kHz. FSET is also used for enabling frequency-doubling operation mode by placing a typical 1nF capacitor in parallel with the frequency-setting resistor.
3	5	PRO	External protection. When pulled up, PRO shuts down the IC with a hysteresis.
4	6	FB	Feedback. The output voltage is regulated according to the feedback signal on FB. OLP detection and burst mode control are also performed on FB.
5	1, 2, 7, 8	GND	IC ground.
6	9	S	Source of the internal MOSFET. S is the input for the primary current-sense signal.
-	13	NC	No connection.
8	14	D	Drain of the internal MOSFET. D is the input for the start-up high voltage current source.

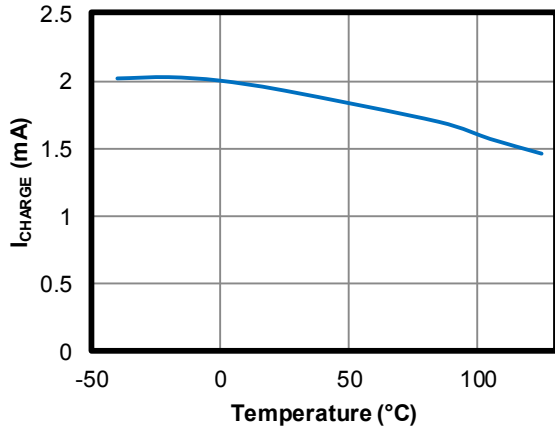
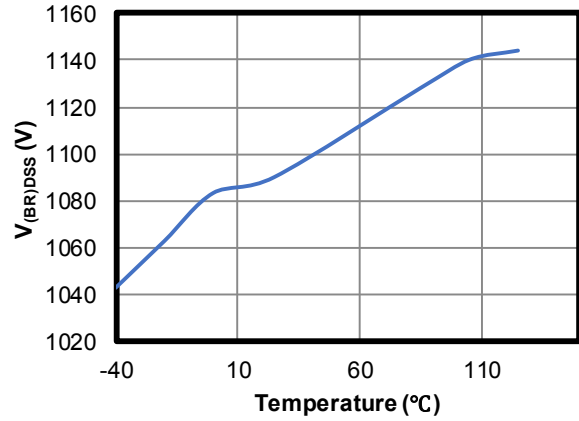
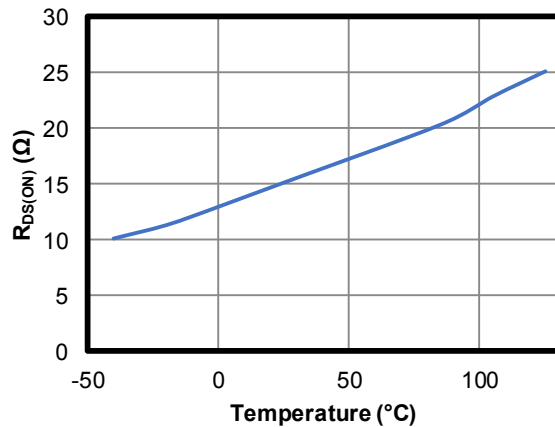
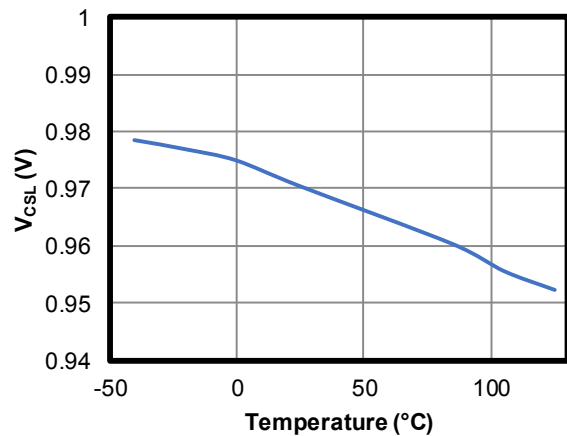
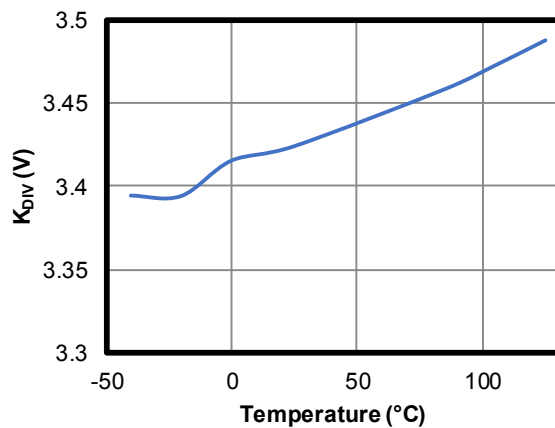
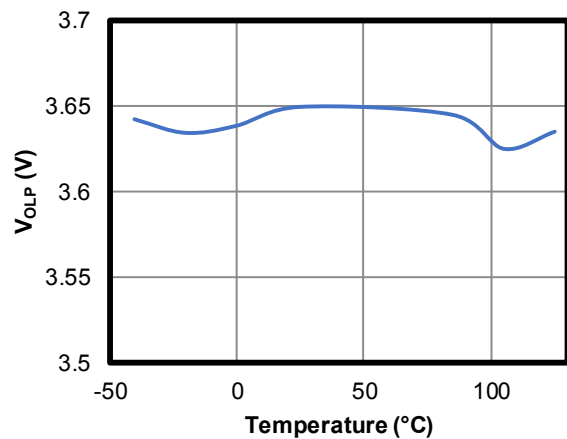
TYPICAL CHARACTERISTICS
 I_{CHARGE} @ $V_D = 400V$ vs. Temperature

 $V_{(BR)DSS}$ @ $I_{Leak} = 100\mu A$ vs. Temperature

 $R_{DS(ON)}$ vs. Temperature

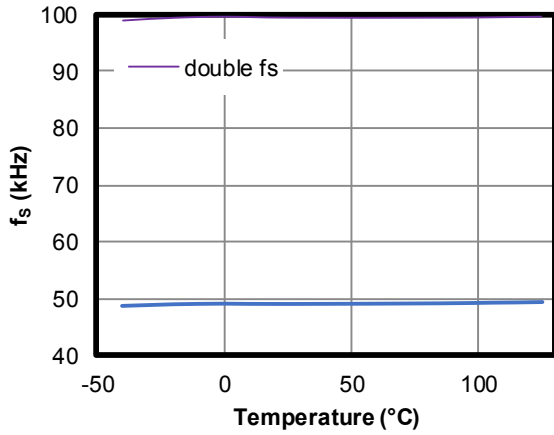
 V_{CSL} vs. Temperature

 K_{DIV} vs. Temperature

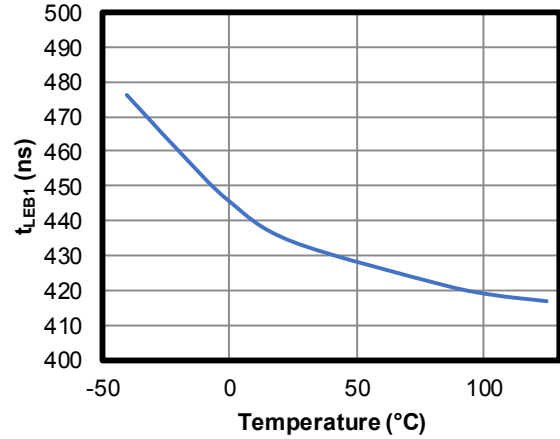
 V_{OLP} vs. Temperature

TYPICAL CHARACTERISTICS (continued)

f_s vs. Temperature



t_{LEB1} vs. Temperature



t_{LEB2} vs. Temperature

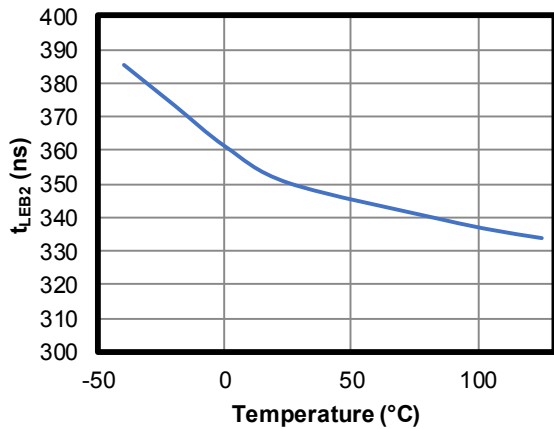

V_{PRO} vs. Temperature

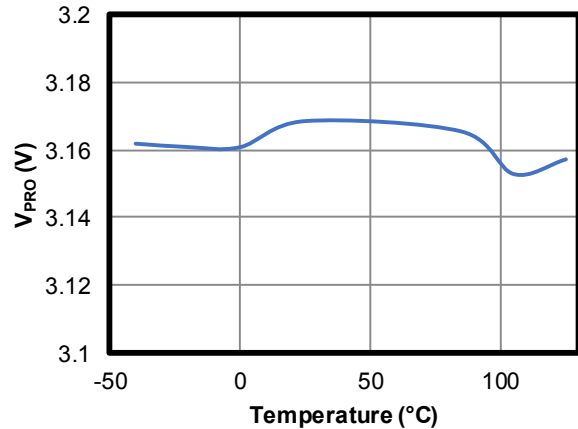

TYPICAL PERFORMANCE CHARACTERISTICS

Performance waveforms are tested with the evaluation board in the Design Example section. $V_{IN} = 230V$, $V_{OUT1} = 13.5V$, $I_{OUT1} = 300mA$, $V_{OUT2} = 8V$, $I_{OUT2} = 50mA$, $V_{OUT3} = 8V$, $I_{OUT3} = 50mA$, $T_A = 25^\circ C$, unless otherwise noted.

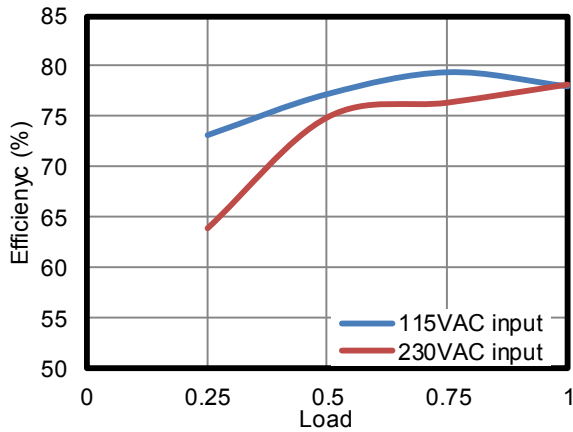
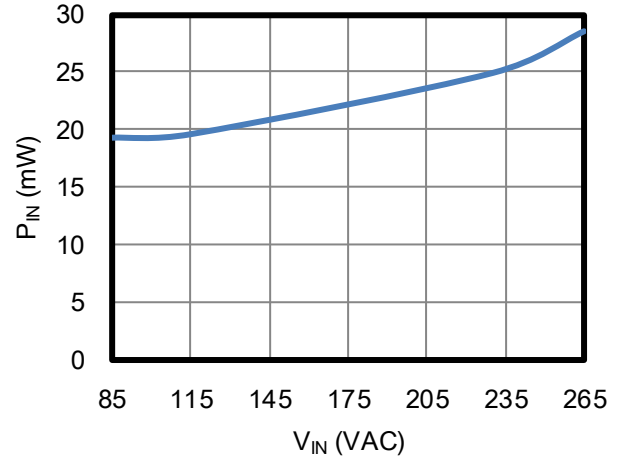
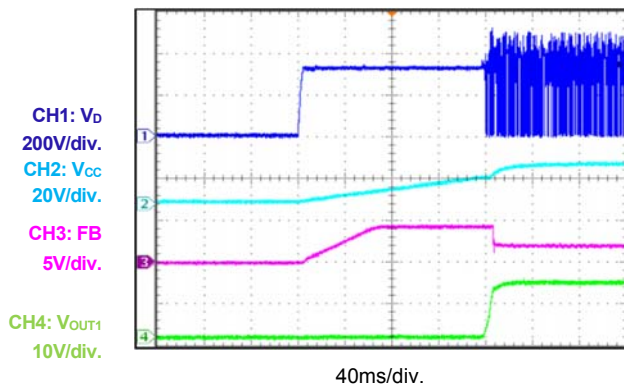
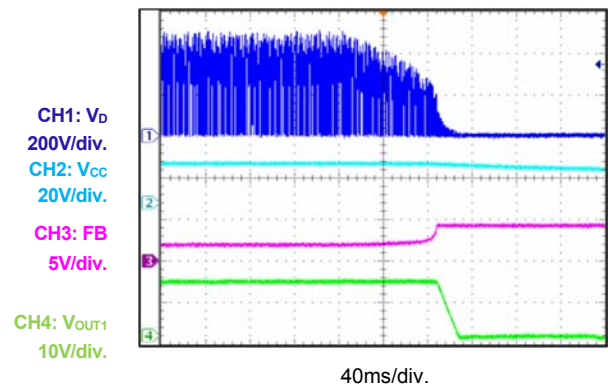
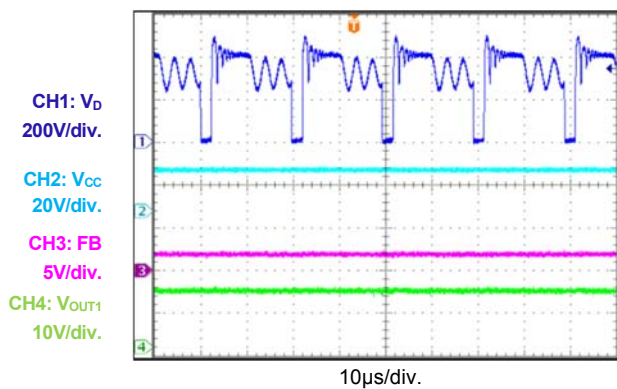
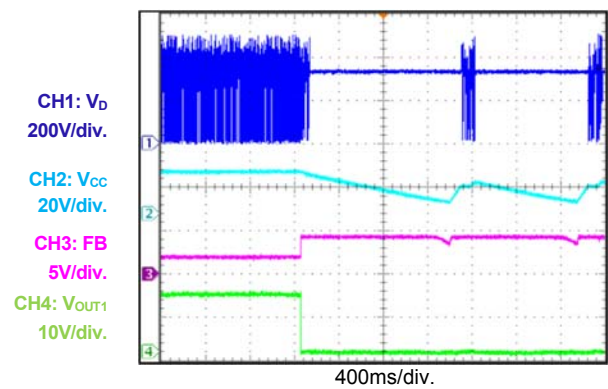
Efficiency

No-Load Consumption ⁽⁶⁾

Power On

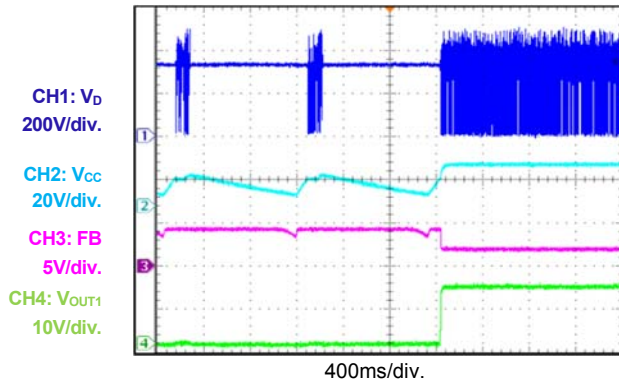
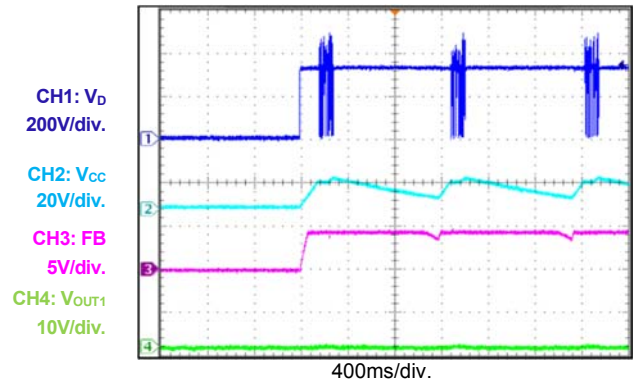
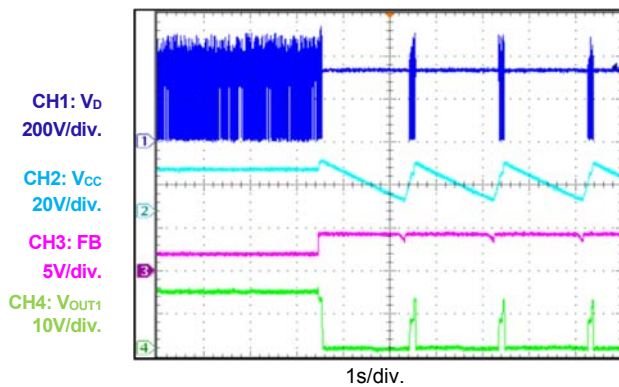
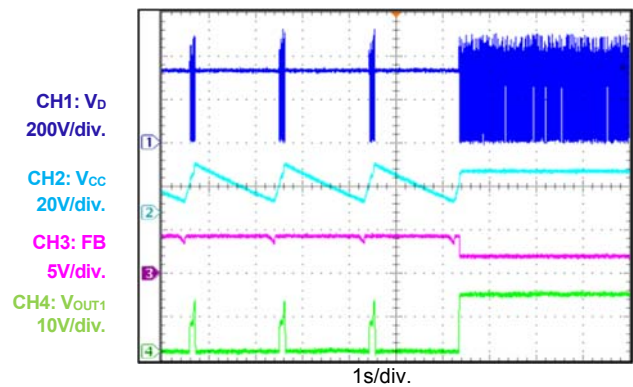
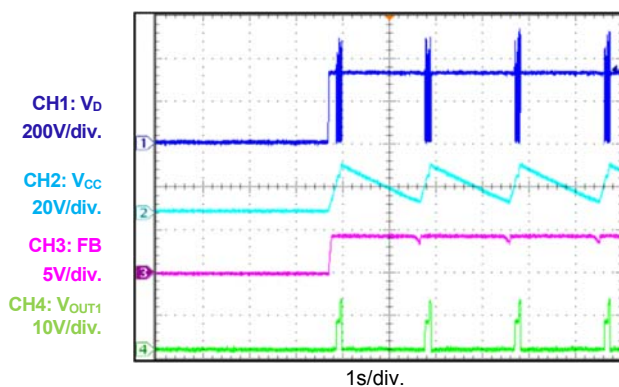
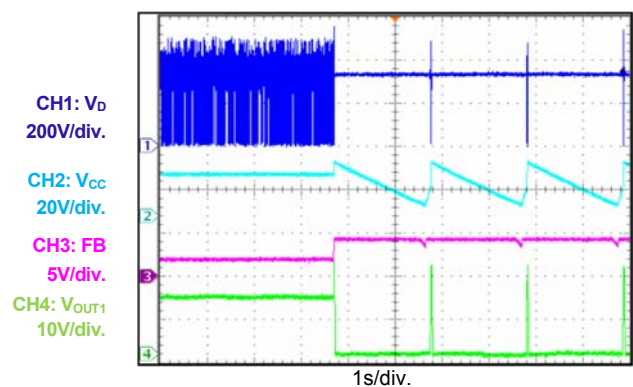
Power Off

Normal Operation

Short-Circuit Entry

TYPICAL PERFORMANCE CHARACTERISTICS (continued)

Performance waveforms are tested with the evaluation board in the Design Example section. $V_{IN} = 230V$, $V_{OUT1} = 13.5V$, $I_{OUT1} = 300mA$, $V_{OUT2} = 8V$, $I_{OUT2} = 50mA$, $V_{OUT3} = 8V$, $I_{OUT3} = 50mA$, $T_A = 25^{\circ}C$, unless otherwise noted.

Short-Circuit Recovery

Short-Circuit Power On

OLP Entry

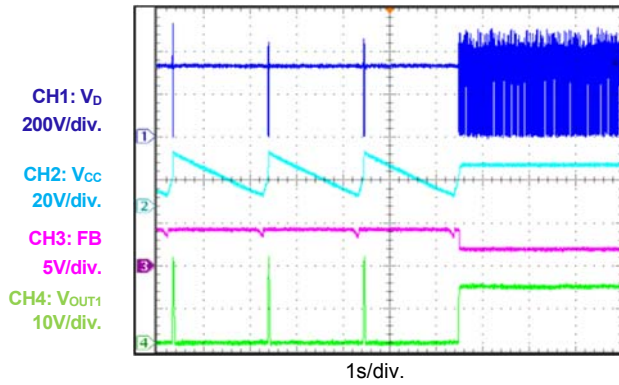
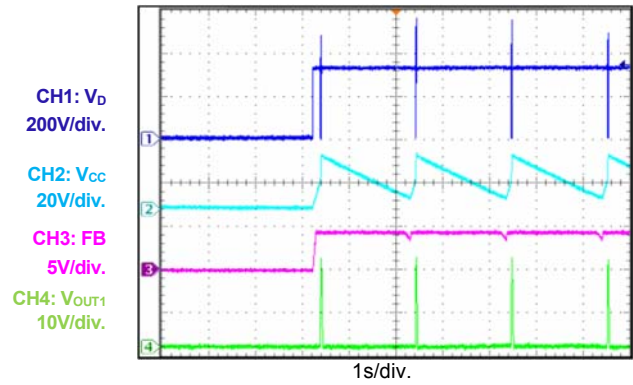
OLP Recovery

OLP Power On

OVP Entry

TYPICAL PERFORMANCE CHARACTERISTICS (continued)

Performance waveforms are tested with the evaluation board in the Design Example section. $V_{IN} = 230V$, $V_{OUT1} = 13.5V$, $I_{OUT1} = 300mA$, $V_{OUT2} = 8V$, $I_{OUT2} = 50mA$, $V_{OUT3} = 8V$, $I_{OUT3} = 50mA$, $T_A = 25^{\circ}C$, unless otherwise noted.

OVP Recovery

OVP Power On

NOTE:

6) The no load consumption is tested with OUT2 and OUT3 open.

BLOCK DIAGRAM

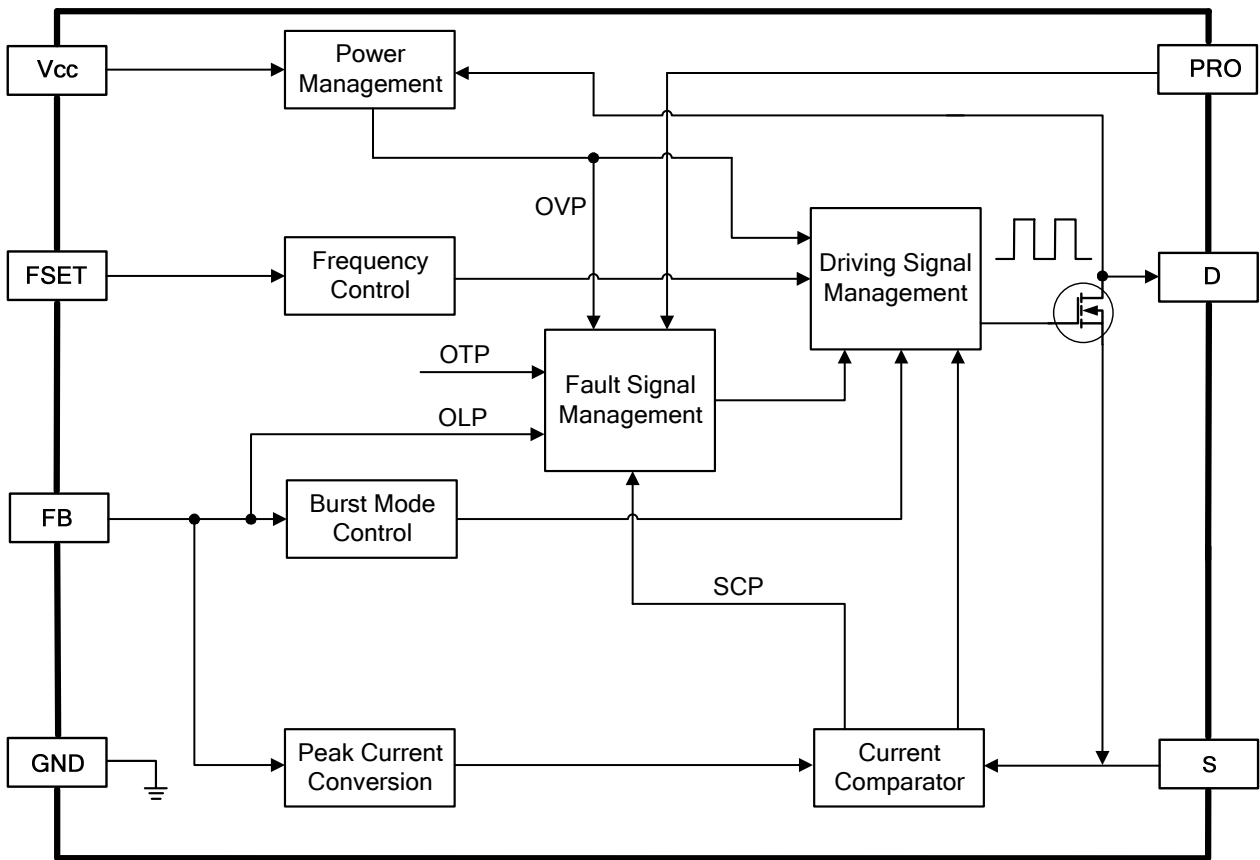

Figure 1: Internal Functional Block Diagram

OPERATION

The HF920 incorporates all of the necessary features required by a reliable switch-mode power supply. The proprietary, 900V, monolithic integration enables a highly integrated power supply solution. The HF920 uses burst-mode operation to minimize the stand-by power consumption at light load. Protection features such as auto-recovery for overload protection (OLP), short-circuit protection (SCP), over-voltage protection (OVP), and thermal shutdown for over-temperature protection (OTP) contribute to a safer converter design with minimal external components.

Pulse-Width Modulation (PWM) Operation

The HF920 employs peak-current-mode control. On the secondary side, the output voltage is regulated by the compensation network, and the compensation output is fed back to the primary side as an input signal to FB through an optical coupler. The FB voltage (V_{FB}) is used to control the peak current on the primary side winding of the flyback transformer based on the current sensing on S. The integrated 900V MOSFET turns on at the beginning of each cycle based on the internal oscillator and turns off based on the peak current control.

Start-Up and VCC UVLO

Initially, the IC is driven by the internal current source drawn from the high-voltage D pin. The IC begins switching, and the internal high-voltage current source turns off once the VCC voltage reaches its upper threshold (V_{CCH}). Then, the IC supply is taken over by the auxiliary winding of the transformer. Whenever VCC falls below its lower threshold (V_{CCL}), the regulator stops switching, and the internal high-voltage current source turns on again (see Figure 2).

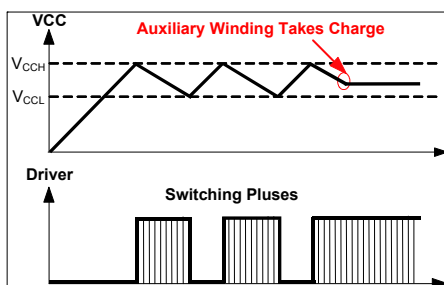

Figure 2: VCC Start-Up

The lower VCC under-voltage lockout (UVLO) threshold decreases from V_{CCL} to V_{CCR} when a fault condition (such as SCP, OLP, OVP, or OTP) occurs.

Soft Start (SS)

The HF920 implements an internal soft-start circuit to reduce stress on the primary-side MOSFET and secondary diode and to smoothly establish the output voltage during start-up. The internal soft-start circuit increases the threshold of the peak-current comparator gradually from the minimal level until the feedback control loop takes over. The maximum soft-start time is t_{SS} . Within the soft-start duration, the switching frequency is also increased progressively from 20 - 100% of the programmed switching frequency.

Switching Frequency

The switching frequency can be set by a resistor between FSET and GND. The oscillator frequency can be calculated with Equation (1):

$$f_s = \frac{1}{523 \times 10^{-9} + 123.4 \times 10^{-12} \times \frac{R_{FSET}}{V_{FST}}} \text{ Hz} \quad (1)$$

Where V_{FSET} is the internal reference voltage on FSET.

Frequency Jittering

The HF920 provides a frequency jittering function, which simplifies the input EMI filter design and decreases system cost. The HF920 has optimized frequency jittering with a $\pm 3.5\%$ frequency deviation range and a $256T_S$ carrier cycle that improves EMI effectively by spreading the energy dissipation over the frequency range.

Frequency Doubling

Connect a 1nF capacitor to FSET to enable the frequency doubling. The switching frequency is doubled when the converter enters an over-power condition (FB voltage rises to V_{OLP}). This way, the converter is able to handle up to a 50% decrease of the transformer inductance caused by external magnetizing interference.

Peak Current Limit

The primary peak current is sensed by a sensing resistor between S and GND. When the sum of the sense resistor voltage and the slope compensation voltage reaches the peak current limit (V_{CS}), the MOSFET turns off.

The peak current limit is set by V_{FB} , as $V_{CS} = V_{FB} / K_{div}$, for all normal operations. The maximum value of peak current limit is limited to V_{CSL} internally. This way, the output power is always limited to prevent excessive stress on the power supply.

Burst Operation

The HF920 implements burst-mode operation at no-load and light-load conditions. Burst-mode operation enables and disables the switching pulse of the MOSFET alternately to reduce switching loss. This helps minimize the stand-by power consumption and achieve high light-load efficiency.

As the load decreases, V_{FB} decreases. The IC stops switching when V_{FB} drops below V_{BURL} . As the converter stops and the output voltage drops, V_{FB} rises again due to the negative feedback control loop. Once V_{FB} goes over V_{BURH} , the switching pulse resumes. If the load condition remains the same, V_{FB} decreases, and the entire process is repeated.

Figure 3 shows the burst mode operation of the HF920.

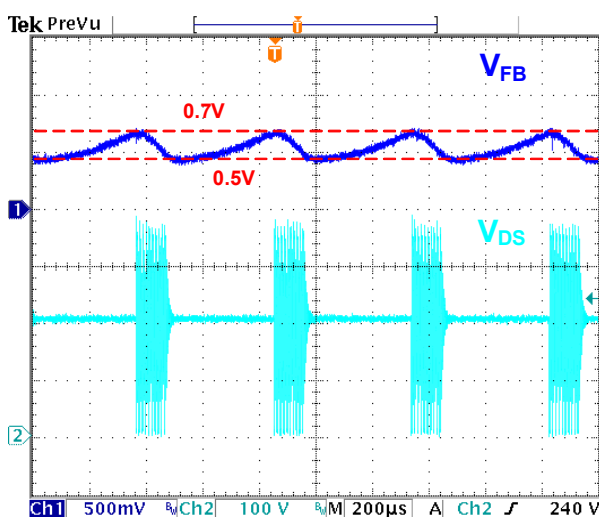

Figure 3: Burst-Mode Operation

Over-Voltage Protection (OVP)

The HF920 shuts down via OVP when VCC rises above V_{OVP} for t_{OVP} . In a flyback application, the auxiliary winding output voltage is proportional to the output voltage, so OVP protects the circuit from overstress during an output over-voltage condition. The HF920 restarts automatically after VCC drops to V_{CCR} . The regulator resumes normal operation once the fault disappears.

Overload Protection (OLP)

The HF920 shuts down when OLP is triggered. The OLP fault occurs when V_{FB} is pulled up to V_{OLP} for 8192 switching cycles. The HF920 restarts automatically when VCC drops to V_{CCR} . When the fault disappears, the power supply resumes operation.

If frequency doubling is enabled, the HF920 doubles the switching frequency when V_{FB} rises to the OLP point.

Short-Circuit Protection (SCP)

The HF920 shuts down when the S voltage is higher than V_{SCP} , which indicates a short circuit. The HF920 enters short-circuit protection (SCP), which prevents any thermal or stress damage. The HF920 restarts automatically when VCC drops to V_{CCR} . Once the fault disappears, the power supply resumes operation.

Thermal Shutdown (OTP)

When the junction temperature of the IC exceeds 150°C , over-temperature protection (OTP) is activated, and the main power MOSFET stops switching to protect the HF920 from thermal damage. During the protection period, the regulator is latched off. VCC is discharged to V_{CCR} and recharged to V_{CCH} by the internal high-voltage current source. Once the junction temperature drop exceeds the thermal shutdown recovery hysteresis, the HF920 resumes operation.

PRO

PRO provides external protection. The HF920 is shut down when the PRO voltage exceeds V_{PRO} and resumes operation once the fault disappears. PRO protection can be used for input OVP or any other protections (input UVP, OTP for key components, etc.).

Leading-Edge Blanking (LEB)

The HF920 implements a leading-edge blanking (LEB) unit to prevent the MOSFET from turning off prematurely due to its high turn-on current spike. During the blanking time, the current sensing signal on S is blocked.

The LEB unit contains two LEB times. The current sensor LEB inhibits the current limitation comparator for T_{LEB1} , and the SCP LEB inhibits the SCP current comparator for T_{LEB2} . Figure 4 shows the primary current sense waveform and the LEB.

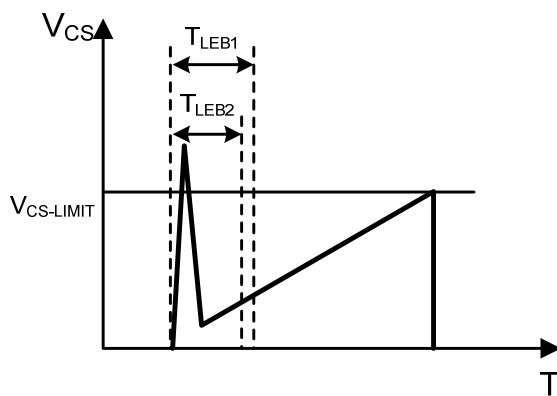

Figure 4: Leading-Edge Blanking

APPLICATION INFORMATION

Selecting the Input Capacitor

The input bulk capacitor filters the rectified AC input voltage and hold the bus voltage for the converter. Figure 5 shows the typical DC bus voltage waveform of a full-bridge rectifier.

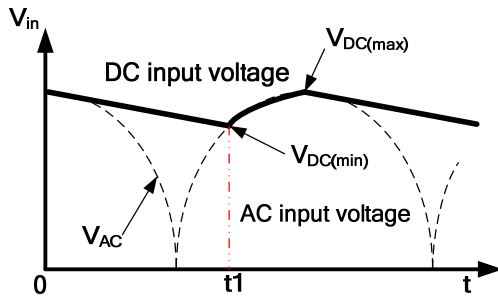

Figure 5: Input Voltage Waveform

When a full-bridge rectifier is used, the input capacitor is set at $2\mu\text{F}/\text{W}$ for the universal input condition ($85 \sim 265\text{V}_{\text{AC}}$), typically. For high-voltage input applications ($>185\text{V}_{\text{AC}}$), cut the capacitor values in half. Very low DC input voltages can cause thermal problems under heavy-load conditions. It is recommended that the minimum DC voltage is higher than 70V. Estimate the minimum DC voltage with the following procedure.

First, estimate the input power (P_{in}) with Equation (2):

$$P_{\text{in}} = \frac{V_o \times I_o}{\eta} \quad (2)$$

Where V_o is the output voltage, I_o is the rated output current, and η is the estimated efficiency. Generally, η is between 0.75 and 0.85 depending on the input range and output application.

Then, the linear part of the DC input voltage (V_{DC}) can be expressed with Equation (3):

$$V_{\text{DC}}(t) = \sqrt{V_{\text{AC(peak)}}^2 - \frac{2 \times P_{\text{in}}}{C_{\text{in}}} \times t} \quad (3)$$

At t_1 , the DC bus voltage reaches its minimum value, and the AC input starts charging the input capacitor. t_1 can be calculated with Equation (4):

$$V_{\text{DC}}(t_1) = V_{\text{AC}}(t_1) \quad (4)$$

$V_{\text{DC(min)}}$ can then be calculated with t_1 and Equation (4). A larger input capacitor should be used if the estimated $V_{\text{DC(min)}}$ is too low.

As a 900V offline regulator, the HF920 is ideal for very high-voltage input applications, which means a very high bus voltage is beyond the rated voltage of normal high voltage electrolytic capacitors. To meet the high bus voltage requirement, stack capacitors as shown in Figure 6.

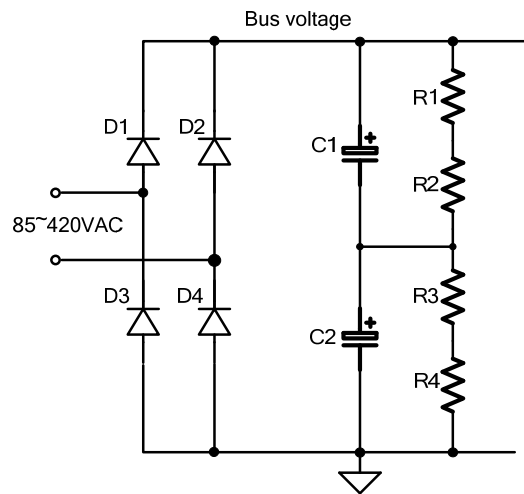

Figure 6: Input Stacked Capacitor Circuit

The same type of capacitors should be chosen for C1 and C2 to balance their voltages. Each capacitor endures half of the bus voltage, but due to the capacitance distribution (typically $\pm 20\%$ for electrolytic capacitors), their voltage varies in mass production. In this case, R1 to R4 should be used as the voltage balancing resistors.

To balance the voltage on C1 and C2, R1 to R4 should have the same value. R1 to R4 should be a 1206 package size to meet the voltage rating requirement. The R1 to R4 values should also be large enough for energy savings. For example, the total value of R1 to R4 is $20\text{M}\Omega$, which consumes about 18mW at a 600V_{DC} bus voltage.

Voltage Stress on the Primary MOSFET

Typically, the maximum voltage stress on the primary MOSFET is design to be less than 90% of its breakdown voltage for reliable operation.

The maximum voltage stress occurs when the primary MOSFET turns off and can be calculated with Equation (5):

$$V_{DS(max)} = V_{BUS(max)} + N(V_O + V_F) + V_{spike} \quad (5)$$

Where V_F is the rectifier diode's forward voltage, V_O is the output voltage, N is the primary-to-secondary turns ratio, and V_{spike} is the voltage spike caused by the transformer's primary leakage inductance.

According to Equation (5), voltage stress can be reduced either by choosing a small N or V_{spike} . However, a small N leads to larger secondary stress, which means there is a trade-off to make. A small V_{spike} requires a strong snubber to suppress the voltage spike.

The input circuit should be designed to guarantee a proper $V_{BUS(max)}$ (i.e.: using suppression components to protect it from surge).

Primary-Side Inductor Design (L_m)

Typically, the converter is designed to operate in continuous conduction mode (CCM) under a low input voltage for universal input applications. With a built-in slope compensation function, the HF920 supports stable CCM control when the duty cycle exceeds 50%. Set the ratio (K_P) of the primary inductor ripple current amplitude vs. the peak current value to $0 < K_P \leq 1$, where a smaller K_P means a deeper CCM, and $K_P = 1$ stands for boundary conduction mode (BCM) and discontinuous conduction mode (DCM). Figure 7 shows the relevant waveforms. A larger primary inductance leads to a smaller K_P , which reduces the RMS current but increases the transformer size. For most HF920 applications, an optimal K_P value is between 0.8 and 1, considering the wide input range.

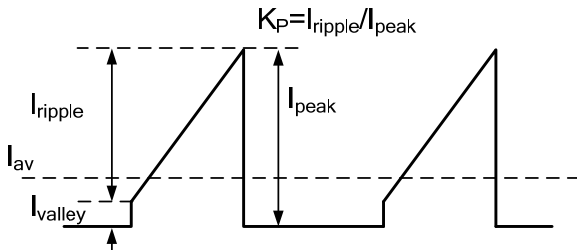

Figure 7: Typical Primary Current Waveform

For CCM at a minimum input, the converter duty cycle can be determined with Equation (6):

$$D = \frac{(V_O + V_F) \times N}{(V_O + V_F) \times N + V_{DC(min)}} \quad (6)$$

Where V_F is the secondary diode's forward voltage, and N is the transformer turns ratio.

The MOSFET turn-on time can be calculated with Equation (7):

$$T_{ON} = \frac{D}{f_s} \quad (7)$$

Where f_s is the operating frequency.

The input average current, ripple current, peak current, and valley current of the primary side are calculated using Equation (8), Equation (9), Equation (10), and Equation (11):

$$I_{AV} = \frac{P_{in}}{V_{DC(min)}} \quad (8)$$

$$I_{ripple} = K_P \times I_{peak} \quad (9)$$

$$I_{peak} = \frac{I_{AV}}{(1 - \frac{K_P}{2}) \times D} \quad (10)$$

$$I_{valley} = (1 - K_P) \times I_{peak} \quad (11)$$

Estimate L_m using Equation (12):

$$L_m = \frac{V_{DC(min)} \times T_{ON}}{I_{ripple}} \quad (12)$$

Current-Sense Resistor

Figure 8 shows the peak current control waveform with slope compensation.

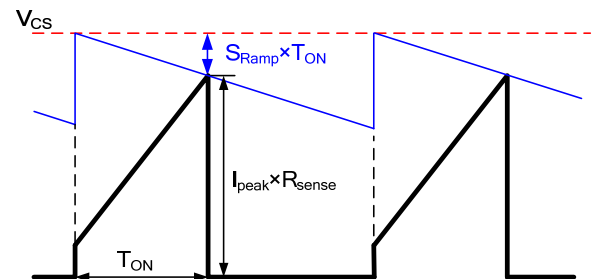

Figure 8: Peak Current Control Waveform with Slope Compensation

When the sum of the sense resistor voltage and the slope compensation voltage reaches the peak current limit (V_{CS}), the HF920 turns off the internal MOSFET. V_{CS} equals the maximum current-set point (V_{CSL}) under full load. Considering the margin, use $0.95 \times V_{CSL}$ for designs. The voltage on the sense resistor can be calculated using Equation (13):

$$V_{\text{sense}} = 0.95 \times V_{\text{CSL}} - S_{\text{Ramp}} \times T_{\text{ON}} \quad (13)$$

Where S_{RAMP} is the slope compensation ramp in proportion to f_s . Typically, $S_{\text{RAMP}} = 21\text{mV}/\mu\text{s}$ when $R_{\text{FSET}} = 200\text{k}\Omega$.

The value of the sense resistor is calculated using Equation (14):

$$R_{\text{sense}} = \frac{V_{\text{sense}}}{I_{\text{peak}}} \quad (14)$$

The current-sense resistor should be chosen with an appropriate power rating. Its power loss can be calculated with Equation (15):

$$P_{\text{sense}} = \left[\left(\frac{I_{\text{peak}} + I_{\text{valley}}}{2} \right)^2 + \frac{1}{12} \times (I_{\text{peak}} - I_{\text{valley}})^2 \right] \times D \times R_{\text{sense}} \quad (15)$$

Input Over-Voltage Protection on PRO

A typical input OVP circuitry of the HF920 is shown in Figure 9. The input OVP point can be calculated with Equation (16):

$$V_{\text{INOVVP}} = V_{\text{PRO}} \times \frac{R5 + R6 + R7 + R8}{R8} \quad (16)$$

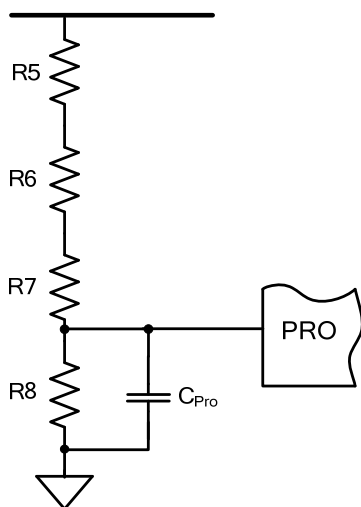

Figure 9: Input Over-Voltage Protection Set-Up

For resistors R5 to R7, 1206 packages should be used to meet the voltage rating requirement. The total value should be larger than $10\text{M}\Omega$ for energy-saving purposes.

Switching noise may couple to these large resistors and disturb the PRO protection. It is recommended to connect a bypass ceramic capacitor to PRO. Place this capacitor as close to the IC as possible.

Thermal Performance Optimization

The HF920 is dedicated to high input voltage applications. However, the high input voltage can cause a greater switching loss on the MOSFET, which can lead to poor thermal performance. Measures should be taken to reduce the switching loss when designing these applications.

First, try to use a lower switching frequency if possible. Then use a small transformer turns ratio to minimize the reflected voltage on the primary winding. Thus, V_{DS} is reduced. Finally, reduce the turn-on loss, since the turn-on loss composes a large part of the switching loss.

Turn-on loss is the product of the turn-on current spike and V_{DS} . Reducing the turn-on loss can be achieved by reducing V_{DS} or the turn-on current spike.

Reducing V_{DS} by using a small turns ratio is discussed above. Another way of reducing V_{DS} when the MOSFET turns on is to set the HF920 to work under deep DCM. In deep DCM, the V_{DS} oscillation is fully damped, so there is no chance of turning on at the high peak value.

The turn-on current spike is caused by a parasitic capacitor and output diode reverse recovery.

DCM operation helps prevent the output diode's reverse recovery. The transformer structure should be designed to achieve minimum parasitic capacitance of each winding and between the primary and secondary windings.

PCB Layout Guidelines

Efficient PCB layout is critical for achieving reliable operation, good EMI performance, and good thermal performance. For best results, refer to Figure 10 and follow the guidelines below.

1. Minimize the power stage switching stage loop area. This includes the input loop (C8–C6–T1–U2–R21/R22–C8), the auxiliary winding loop (T1–D6–R16–C11–T1), the output loop (T1–D6–C9–T1, T1–D1–C1–T1, and T1–D2–C3–T1), and the RCD loop (T1–D5–R5/R7/C4–T1).
2. Ensure that the power loop ground does not pass through the control circuit ground. If a heat sink is used, connect it to the primary GND plane to improve EMI and thermal dissipation.
3. Place the control circuit capacitors (for FB, PRO, and VCC) close to the IC to decouple the switching noise.
4. Enlarge the GND pad near the IC for good thermal dissipation.
5. Keep the EMI filter far away from the switching point.
6. Ensure enough clearance distance to meet the insulation requirement.

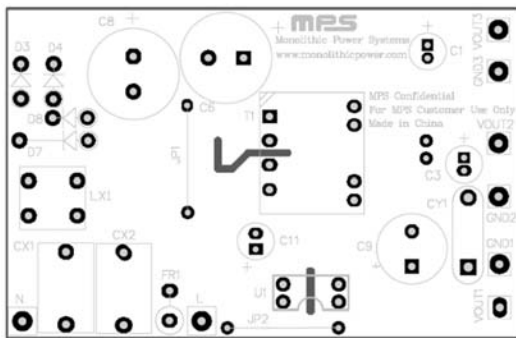

Top

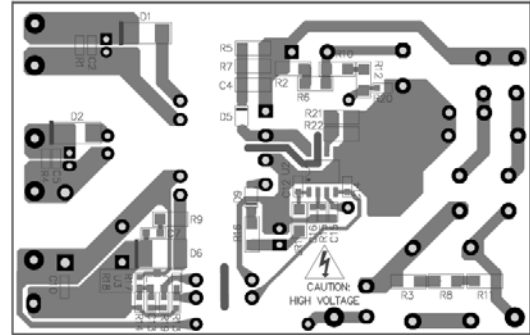

Bottom

Figure 10: Recommended Layout

Design Example

Table 2 is a design example using the application guidelines for the given specifications.

Table 2: Design Example

V_{IN}	85 to 420VAC
V_{OUT1}	13.5V
I_{OUT1}	0.3A
V_{OUT2}	8V
I_{OUT2}	0.05A
V_{OUT3}	8V
I_{OUT3}	0.05A
f_s	50kHz

The detailed application schematic is shown in Figure 11. The typical performance and circuit waveforms are shown in the Typical Performance Characteristics section. For more device applications, please refer to the related evaluation board datasheets.

TYPICAL APPLICATION CIRCUIT

Figure 11: Typical Application Schematic

Figure 12: Transformer Structure

Table 3: Winding Order

Tape (T)	Winding	Terminal Start → End	Wire Size (Φ)	Turns (T)
1	N1	1 → NC	0.15mm*2	22
1	N2	2 → 1	0.15mm*1	170
1	N3	4 → 3	0.1mm*1	26
1	N6	5 → 6	0.3mm TIW *1	26
1	N4	10 → 9	0.16mm TIW *1	16
1	N5	A → B	0.16mm TIW *1	16

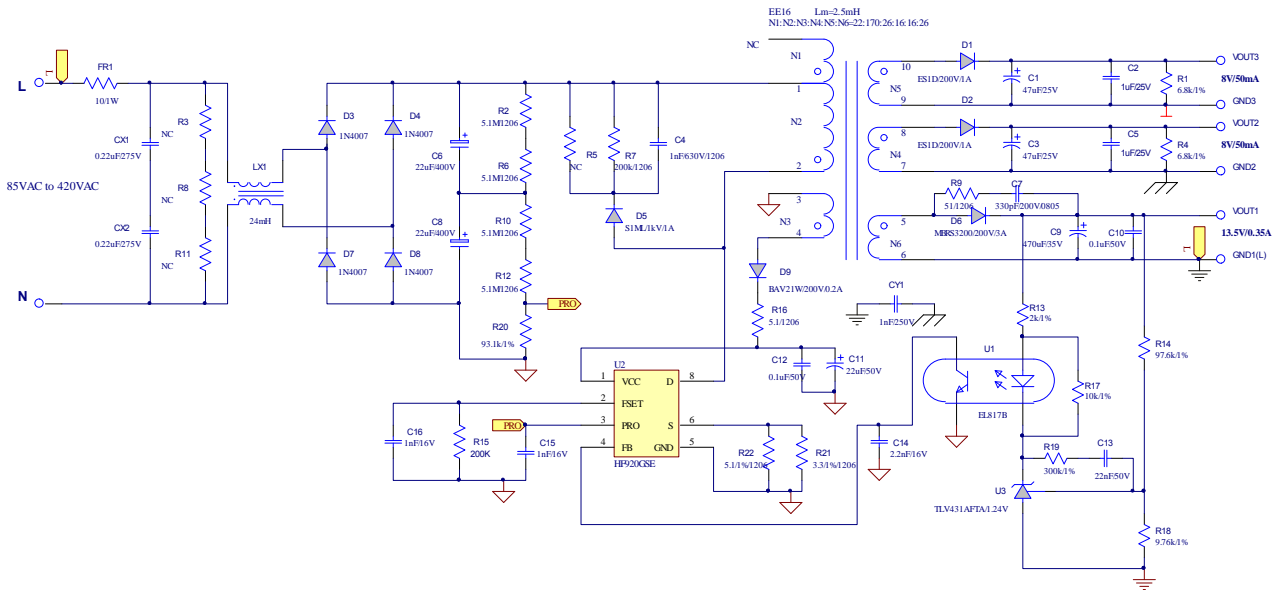
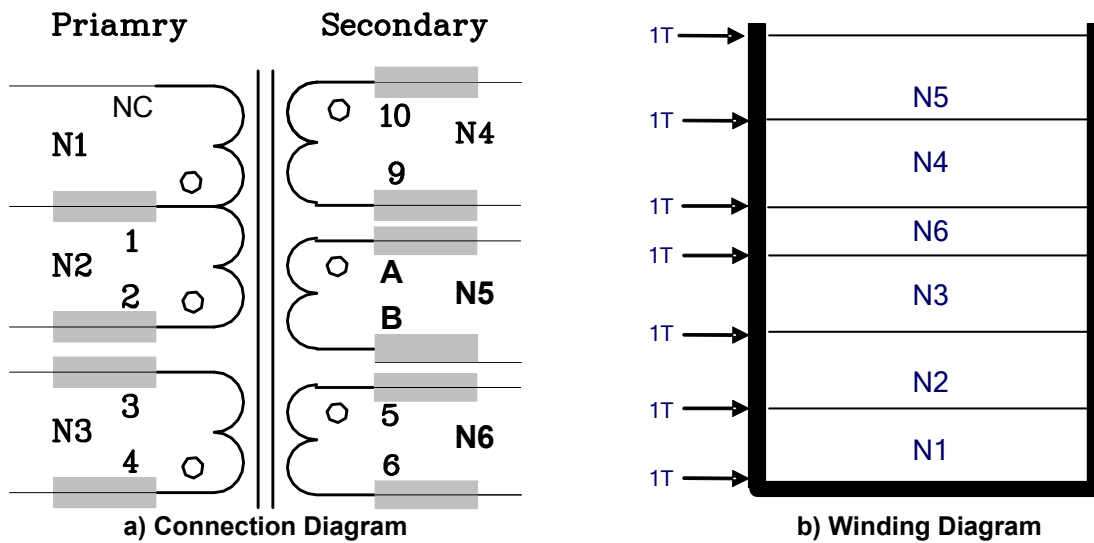
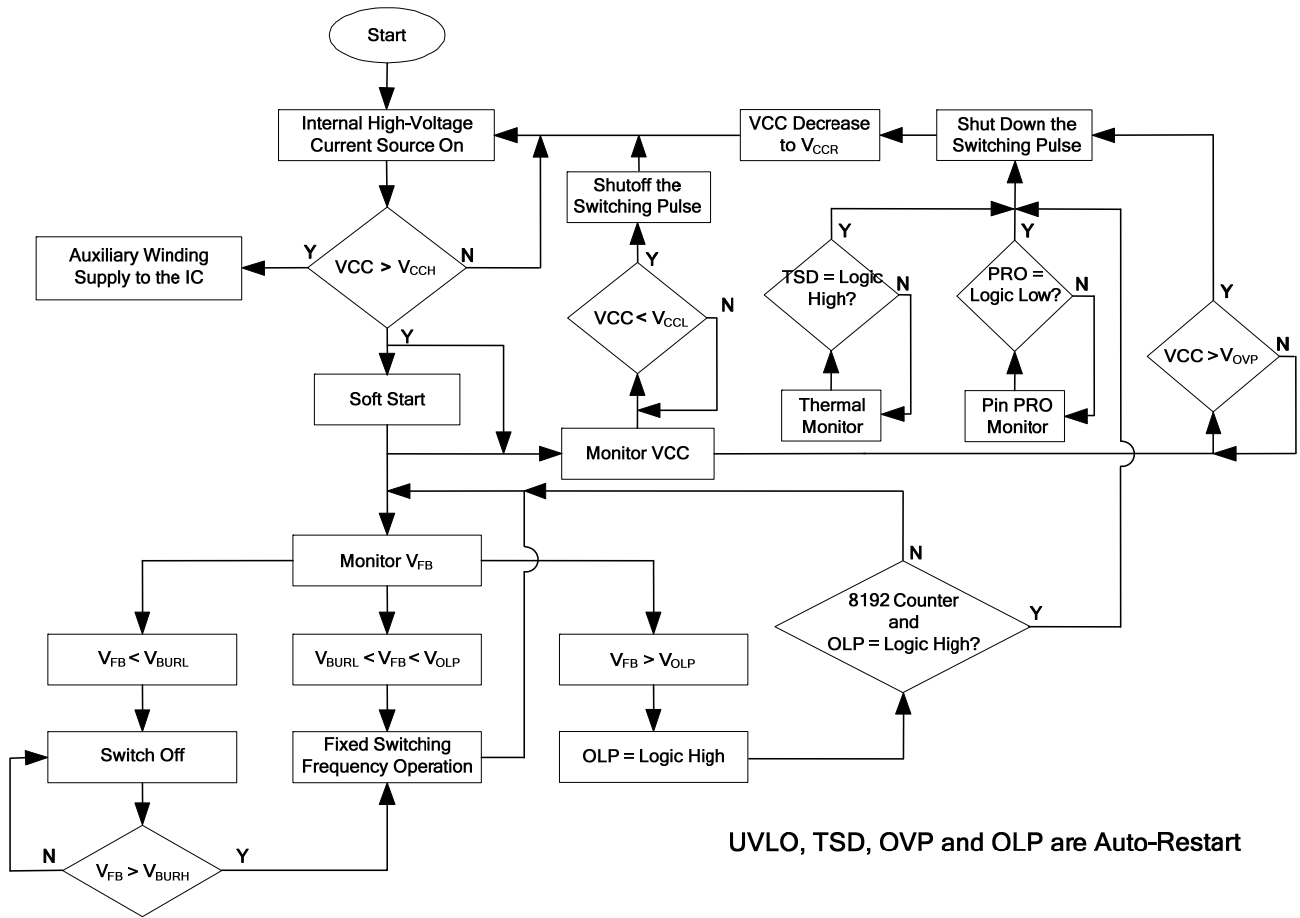
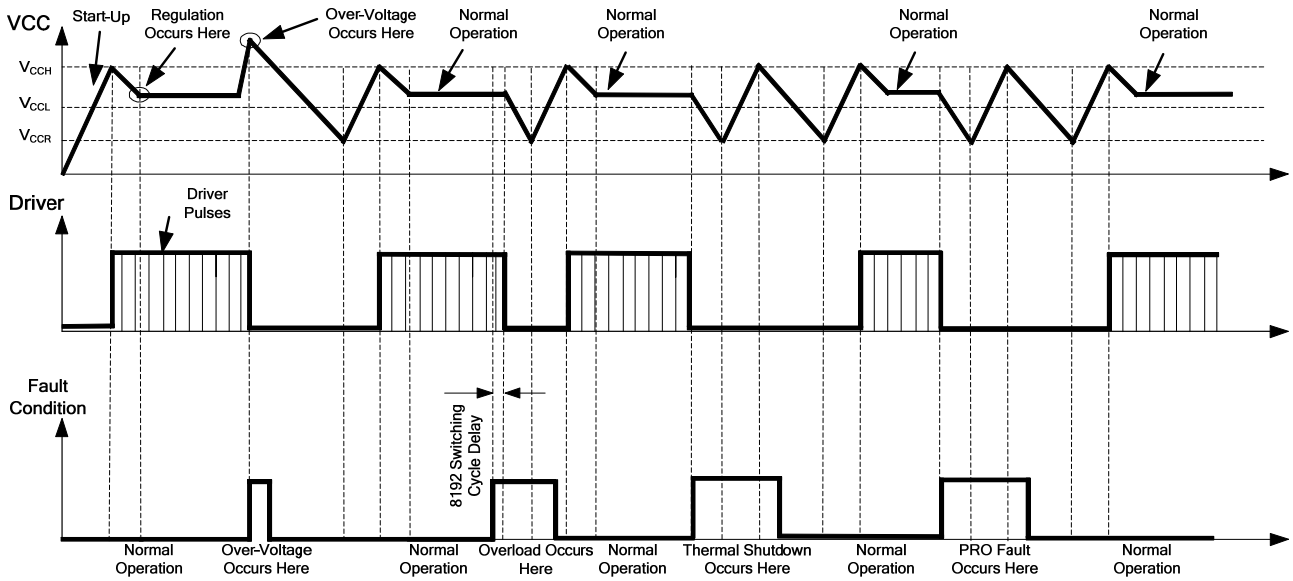
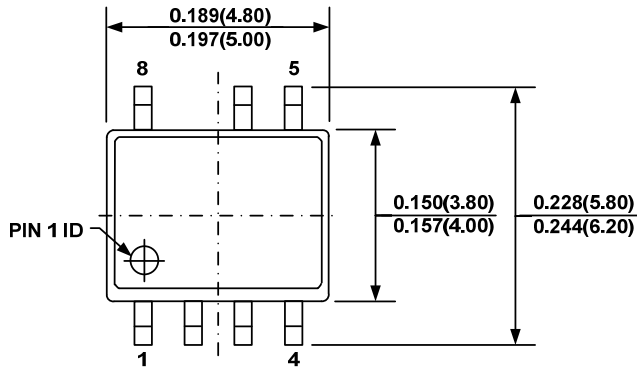
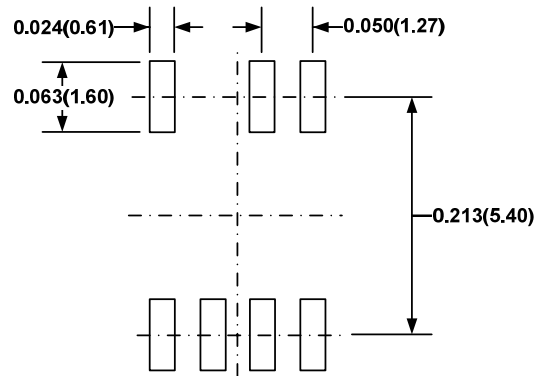
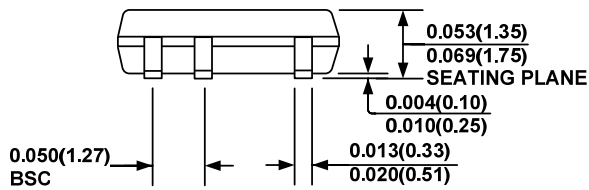
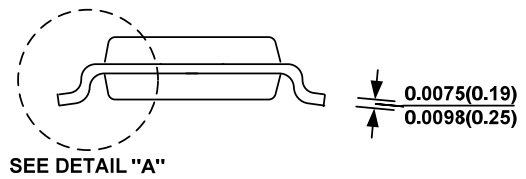
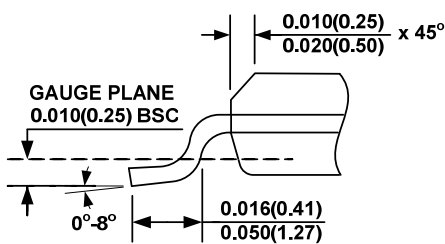
FLOW CHART

EVOLUTION OF THE SIGNALS IN PRESENCE OF FAULTS

PACKAGE INFORMATION
SOIC8-7A

TOP VIEW

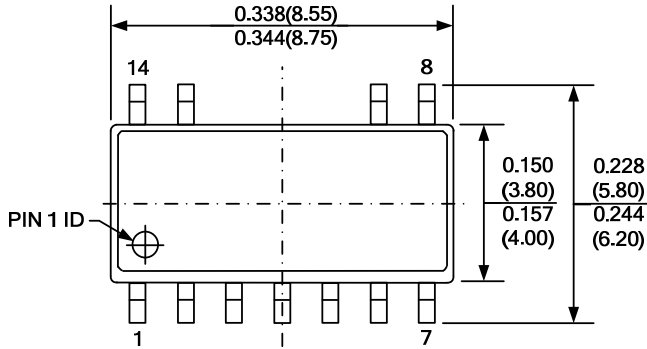
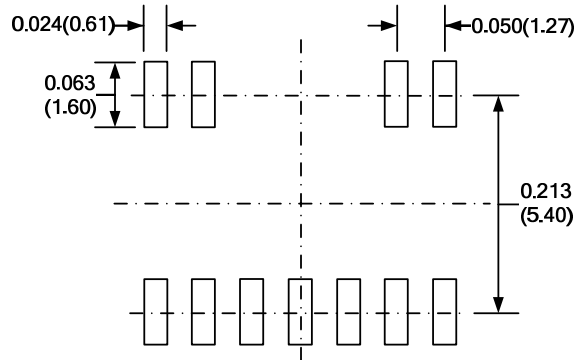
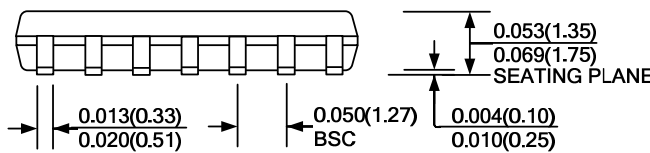
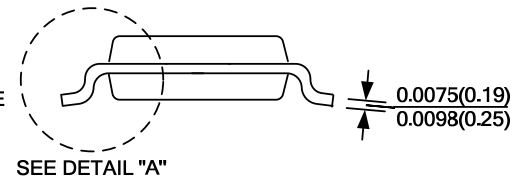
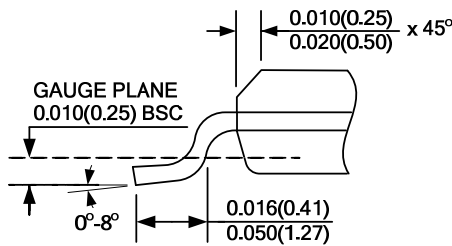
RECOMMENDED LAND PATTERN

FRONT VIEW

SIDE VIEW

DETAIL "A"
NOTE:

- 1) CONTROL DIMENSION IS IN INCHES. DIMENSION IN BRACKET IS IN MILLIMETERS.
- 2) PACKAGE LENGTH DOES NOT INCLUDE MOLD FLASH, PROTRUSIONS OR GATE BURRS.
- 3) PACKAGE WIDTH DOES NOT INCLUDE INTERLEAD FLASH OR PROTRUSIONS.
- 4) LEAD COPLANARITY (BOTTOM OF LEADS AFTER FORMING) SHALL BE 0.004" INCHES MAX.
- 5) JEDEC REFERENCE IS MS-012.
- 6) DRAWING IS NOT TO SCALE.

PACKAGE INFORMATION (continued)
SOIC14-11

TOP VIEW

RECOMMENDED LAND PATTERN

FRONT VIEW

SIDE VIEW

DETAIL "A"
NOTE:

- 1) CONTROL DIMENSION IS IN INCHES. DIMENSION IN BRACKET IS IN MILLIMETERS.
- 2) PACKAGE LENGTH DOES NOT INCLUDE MOLD FLASH, PROTRUSIONS OR GATE BURRS.
- 3) PACKAGE WIDTH DOES NOT INCLUDE INTERLEAD FLASH OR PROTRUSIONS.
- 4) LEAD COPLANARITY (BOTTOM OF LEADS AFTER FORMING) SHALL BE 0.004" INCHES MAX.
- 5) DRAWING CONFORMS TO JEDEC MS-012, VARIATION AB.
- 6) DRAWING IS NOT TO SCALE.

NOTICE: The information in this document is subject to change without notice. Users should warrant and guarantee that third party Intellectual Property rights are not infringed upon when integrating MPS products into any application. MPS will not assume any legal responsibility for any said applications.