

# Operational Amplifier, Rail-to-Rail Input-Output, Low Power, 4 MHz GBW

## LM7301

The LM7301 operational amplifier provides high performance in a wide range of applications. It features common mode input range beyond the rails, full rail-to-rail output swing, large capacitive load driving capability, and low signal distortion.

The LM7301 operates on supplies of 1.8 V to 32 V and is excellent for a wide range of applications in low power systems. With a gain-bandwidth of 4 MHz while consuming only 0.6 mA supply current, it supports portable applications where higher power devices would reduce battery life.

The wide input common mode voltage range allows the LM7301 to be driven by signals 100 mV beyond both rails, eliminating concerns associated with exceeding the common-mode voltage range. The capability for rail-to-rail output swing provides the maximum possible dynamic range at the output, which is particularly important when operating on low supply voltages.

The LM7301 is available in a space-saving TSOP-5 package.

### Features

- Wide Supply Range: 1.8 V to 32 V
- Input Common Mode Voltage Range Extends Beyond Rails:  
 $V_{EE} - 0.1 \text{ V}$  to  $V_{CC} + 0.1 \text{ V}$
- Rail-to-Rail Output Swing: 0.07 V to 4.93 V at  $V_S = 5 \text{ V}$
- Wide Gain-Bandwidth: 4 MHz
- Low Supply Current: 0.60 mA at  $V_S = 5 \text{ V}$
- High PSRR: 104 dB at  $V_S = 5 \text{ V}$
- High CMRR: 93 dB at  $V_S = 5 \text{ V}$
- Excellent Gain: 97 dB at  $V_S = 5 \text{ V}$
- Capable of Driving a 1 nF Capacitive Load
- Tiny 5-pin SOT23 Package Saves Space
- These Devices are Pb-Free, Halogen Free/BFR Free and are RoHS Compliant

### Typical Applications

- Portable Instrumentation
- Signal Conditioning Amplifiers/ADC Buffers
- Active Filters
- Modems
- PCMCIA Cards



ON Semiconductor®

[www.onsemi.com](http://www.onsemi.com)



TSOP-5  
(SOT23-5)  
SN SUFFIX  
CASE 483

### MARKING DIAGRAM

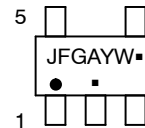

A = Assembly Location  
Y = Year  
W = Work Week  
▪ = Pb-Free Package

(Note: Microdot may be in either location)

### PIN CONNECTIONS

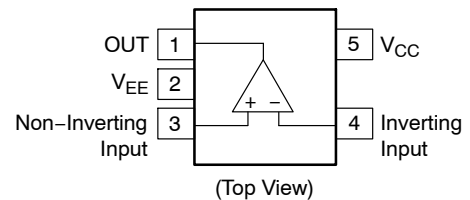

### ORDERING INFORMATION

See detailed ordering and shipping information in the package dimensions section on page 11 of this data sheet.

# LM7301

## PIN FUNCTION DESCRIPTION

Pin No.	Pin Name	Description
1	Output	Amplifier Output
2	$V_{EE}$	Negative Power Supply
3	Non-inverting Input	Non-inverting Amplifier Input
4	Inverting Input	Inverting Amplifier Input
5	$V_{CC}$	Positive Power Supply

## ABSOLUTE MAXIMUM RATINGS

Rating	Symbol	Value	Unit
Input Voltage Common Mode Range	$V_{CM}$	$V_{CC} + 0.3\text{ V}, V_{EE} - 0.3\text{ V}$	V
Differential Input Voltage Range	$V_{diff}$	15	V
Supply Voltage ( $V_{CC} - V_{EE}$ )	$V_S$	35	V
Current at Input Pin	$I_{IN}$	$\pm 10$	mA
Current at Output Pin (Note 1)	$I_{OUT}$	$\pm 20$	mA
Current at Power Supply Pin	$I_{CC}$	25	mA
Maximum Junction Temperature (Note 2)	$T_{J(max)}$	150	$^{\circ}\text{C}$
Storage Temperature Range	$T_{STG}$	-65 to 150	$^{\circ}\text{C}$
ESD Capability, Human Body Model (Note 3)	$ESD_{HBM}$	2.5	kV

Stresses exceeding those listed in the Maximum Ratings table may damage the device. If any of these limits are exceeded, device functionality should not be assumed, damage may occur and reliability may be affected.

- Applies to both single supply and split supply operation. Continuous short circuit operation at elevated ambient temperature can result in exceeding the maximum allowed junction temperature of  $150^{\circ}\text{C}$ .
- The maximum power dissipation is a function of  $T_{J(max)}$ ,  $\theta_{JA}$ , and  $T_A$ . The maximum allowable dissipation at any ambient temperature is  $P_D = (T_{J(max)} - T_A)/\theta_{JA}$ . All numbers apply for packages soldered directly to a printed circuit board.
- Human Body Model, applicable std. MIL-STD-883, method 3015.7.

## THERMAL CHARACTERISTICS

Rating	Symbol	Value	Unit
Thermal Characteristics, SOT-5, 3 x 3.3 mm (Note 4)	$\theta_{JA}$	333	$^{\circ}\text{C}/\text{W}$

- Values based on copper area of  $645\text{ mm}^2$  (or  $1\text{ in}^2$ ) of 1 oz copper thickness and FR4 PCB substrate.

## OPERATING RANGES

Rating	Symbol	Min	Max	Unit
Supply Voltage	$V_S$	1.8	32	V
Operating Temperature Range	$T_A$	-40	85	$^{\circ}\text{C}$

# LM7301

**5.0 V DC ELECTRICAL CHARACTERISTICS** Unless otherwise specified, all limits guaranteed for  $T_A = 25^\circ\text{C}$ ,  $V_{CC} = 5\text{ V}$ ,  $V_{EE} = 0\text{ V}$ ,  $V_{CM} = \text{mid-supply}$ , and  $R_L > 1\text{ M}\Omega$  to mid-supply. **Boldface** limits apply at the temperature extremes.

Symbol	Parameter	Conditions	Min	Typ	Max	Unit
$V_{OS}$	Input Offset Voltage			0.03	6	mV
					<b>8</b>	
$\Delta V_{OS}/\Delta T$	Input Offset Voltage Average Drift			2		$\mu\text{V}/^\circ\text{C}$
$I_{IB}$	Input Bias Current	$V_{CM} = 0\text{ V}$		65	200	nA
					<b>250</b>	
		$V_{CM} = 5\text{ V}$		-55	-75	
					<b>-85</b>	
$I_{OS}$	Input Offset Current	$V_{CM} = 0\text{ V}$		0.7	70	nA
					<b>80</b>	
		$V_{CM} = 5\text{ V}$		0.7	55	
					<b>65</b>	
$R_{IN}$	Input Resistance, Common Mode	$0\text{ V} \leq V_{CM} \leq 5\text{ V}$		39		$\text{M}\Omega$
CMRR	Common Mode Rejection Ratio	$0\text{ V} \leq V_{CM} \leq 5\text{ V}$	70	88		dB
			<b>67</b>			
		$0\text{ V} \leq V_{CM} \leq 3.5\text{ V}$		93		
PSRR	Power Supply Rejection Ratio	$2.2\text{ V} \leq V_S \leq 30\text{ V}$	87	104		dB
			<b>84</b>			
$V_{CM}$	Input Common-Mode Voltage Range	CMRR $\geq 65\text{ dB}$		5.1		V
				-0.1		
$A_V$	Large Signal Voltage Gain	$R_L = 10\text{ k}\Omega$ $V_o = 4.0\text{ V}_{pp}$	82	97		dB
			<b>80</b>			
$V_{OH}$	High Output Voltage Swing	$R_L = 10\text{ k}\Omega$	4.88	4.93		V
			<b>4.85</b>			
		$R_L = 2\text{ k}\Omega$	4.8	4.87		
			<b>4.78</b>			
$V_{OL}$	Low Output Voltage Swing	$R_L = 10\text{ k}\Omega$		0.07	0.12	
					<b>0.15</b>	
		$R_L = 2\text{ k}\Omega$		0.14	0.2	
					<b>0.22</b>	
$I_{SC}$	Output Short Circuit Current	Sourcing	8	10.5		mA
			<b>5.5</b>			
		Sinking	6	9.8		
			<b>5</b>			
$I_S$	Supply Current	$R_L = \text{open}$		0.6	1.1	mA
					<b>1.24</b>	

# LM7301

**AC ELECTRICAL CHARACTERISTICS**  $T_A = 25^\circ\text{C}$ ,  $V_{CC} = 2.2\text{ V to }30\text{ V}$ ,  $V_{EE} = 0\text{ V}$ ,  $V_{CM} = \text{mid-supply}$ , and  $R_L > 1\text{ M}\Omega$  to mid-supply

Symbol	Parameter	Conditions	Min	Typ	Max	Unit
SR	Slew Rate	$\pm 4\text{ V Step @ }V_s = \pm 6\text{ V}$		1.25		V/ $\mu\text{s}$
GBW	Gain-Bandwidth Product	$f = 100\text{ kHz}$ , $R_L = 10\text{ k}\Omega$		4		MHz
$e_N$	Input-Referred Voltage Noise	$f = 1\text{ kHz}$		30		nV/ $\sqrt{\text{Hz}}$
$i_N$	Input-Referred Current Noise	$f = 1\text{ kHz}$		0.24		pA/ $\sqrt{\text{Hz}}$
THD	Total Harmonic Distortion	$f = 10\text{ kHz}$		0.004		%

**2.2 V DC ELECTRICAL CHARACTERISTICS** Unless otherwise specified, all limits guaranteed for  $T_A = 25^\circ\text{C}$ ,  $V_{CC} = 2.2\text{ V}$ ,  $V_{EE} = 0\text{ V}$ ,  $V_{CM} = \text{mid-supply}$ , and  $R_L > 1\text{ M}\Omega$  to mid-supply. **Boldface** limits apply at the temperature extremes.

Symbol	Parameter	Conditions	Min	Typ	Max	Unit
$V_{OS}$	Input Offset Voltage			0.04	6	mV
					<b>8</b>	
$\Delta V_{OS}/\Delta T$	Input Offset Voltage Average Drift			2		$\mu\text{V}/^\circ\text{C}$
$I_{IB}$	Input Bias Current	$V_{CM} = 0\text{ V}$		65	200	nA
					<b>250</b>	
		$V_{CM} = 2.2\text{ V}$		-55	-75	
					<b>-85</b>	
$I_{OS}$	Input Offset Current	$V_{CM} = 0\text{ V}$		0.8	70	nA
					<b>80</b>	
		$V_{CM} = 2.2\text{ V}$		0.4	55	
					<b>65</b>	
$R_{IN}$	Input Resistance, Common Mode	$0\text{ V} \leq V_{CM} \leq 2.2\text{ V}$		18		M $\Omega$
CMRR	Common Mode Rejection Ratio	$0\text{ V} \leq V_{CM} \leq 2.2\text{ V}$	60	82		dB
			<b>56</b>			
PSRR	Power Supply Rejection Ratio	$2.2\text{ V} \leq V_S \leq 30\text{ V}$	87	104		dB
			<b>84</b>			
$V_{CM}$	Input Common-Mode Voltage Range	CMRR $\geq 60\text{ dB}$		2.3		V
				-0.1		
$A_V$	Large Signal Voltage Gain	$R_L = 10\text{ k}\Omega$ $V_o = 1.6\text{ V}_{pp}$	76	93		dB
			<b>74</b>			
$V_{OH}$	High Output Voltage Swing	$R_L = 10\text{ k}\Omega$	2.1	2.15		V
			<b>2</b>			
		$R_L = 2\text{ k}\Omega$	2.07	2.1		
			<b>2</b>			
$V_{OL}$	Low Output Voltage Swing	$R_L = 10\text{ k}\Omega$		0.05	0.08	
					<b>0.1</b>	
		$R_L = 2\text{ k}\Omega$		0.09	0.13	
					<b>0.14</b>	
$I_{SC}$	Output Short Circuit Current	Sourcing	8	8.7		mA
			<b>5.5</b>			
		Sinking	6	8.7		
			<b>5</b>			

# LM7301

**2.2 V DC ELECTRICAL CHARACTERISTICS** Unless otherwise specified, all limits guaranteed for  $T_A = 25^\circ\text{C}$ ,  $V_{CC} = 2.2\text{ V}$ ,  $V_{EE} = 0\text{ V}$ ,  $V_{CM} = \text{mid-supply}$ , and  $R_L > 1\text{ M}\Omega$  to mid-supply. **Boldface** limits apply at the temperature extremes.

Symbol	Parameter	Conditions	Min	Typ	Max	Unit
$I_S$	Supply Current	$R_L = \text{open}$		0.57	0.97	mA
					<b>1.24</b>	

**30V DC ELECTRICAL CHARACTERISTICS** Unless otherwise specified, all limits guaranteed for  $T_A = 25^\circ\text{C}$ ,  $V_{CC} = 30\text{ V}$ ,  $V_{EE} = 0\text{ V}$ ,  $V_{CM} = \text{mid-supply}$ , and  $R_L > 1\text{ M}\Omega$  to mid-supply. **Boldface** limits apply at the temperature extremes.

Symbol	Parameter	Conditions	Min	Typ	Max	Unit
$V_{OS}$	Input Offset Voltage			0.04	6	mV
					<b>8</b>	
$\Delta V_{OS}/\Delta T$	Input Offset Voltage Average Drift			<b>2</b>		$\mu\text{V}/^\circ\text{C}$
$I_{IB}$	Input Bias Current	$V_{CM} = 0\text{ V}$		70	300	nA
					<b>500</b>	
		$V_{CM} = 30\text{ V}$		-60	-100	
					<b>-200</b>	
$I_{OS}$	Input Offset Current	$V_{CM} = 0\text{ V}$		1.2	90	nA
					<b>190</b>	
		$V_{CM} = 30\text{ V}$		0.5	65	
					<b>135</b>	
$R_{IN}$	Input Resistance, Common Mode	$0\text{ V} \leq V_{CM} \leq 30\text{ V}$		200		$\text{M}\Omega$
CMRR	Common Mode Rejection Ratio	$0\text{ V} \leq V_{CM} \leq 30\text{ V}$	80	104		dB
			<b>78</b>			
		$0\text{ V} \leq V_{CM} \leq 27\text{ V}$	90	115		
			<b>88</b>			
PSRR	Power Supply Rejection Ratio	$2.2\text{ V} \leq V_S \leq 30\text{ V}$	87	104		dB
			<b>84</b>			
$V_{CM}$	Input Common-Mode Voltage Range	CMRR $\geq 80\text{ dB}$		30.1		V
					-0.1	
$A_V$	Large Signal Voltage Gain	$R_L = 10\text{ k}\Omega$ $V_o = 28\text{ V}_{pp}$	89	100		dB
			<b>86</b>			
$V_{OH}$	High Output Voltage Swing	$R_L = 10\text{ k}\Omega$	29.75	29.8		V
			<b>28.65</b>			
$V_{OL}$	Low Output Voltage Swing	$R_L = 10\text{ k}\Omega$		0.16	0.275	
					<b>0.375</b>	
$I_{SC}$	Output Short Circuit Current	Sourcing (Note 5)	8.8	17		mA
			<b>6.5</b>			
		Sinking (Note 5)	8.2	14		
			<b>6</b>			
$I_S$	Supply Current	$R_L = \text{open}$		0.7	1.3	mA
					<b>1.35</b>	

5. The maximum power dissipation is a function of  $T_{J(\text{max})}$ ,  $\theta_{JA}$ , and  $T_A$ . The maximum allowable dissipation at any ambient temperature is  $P_D = (T_{J(\text{max})} - T_A)/\theta_{JA}$ . All numbers apply for packages soldered directly to a printed circuit board.

TYPICAL CHARACTERISTICS

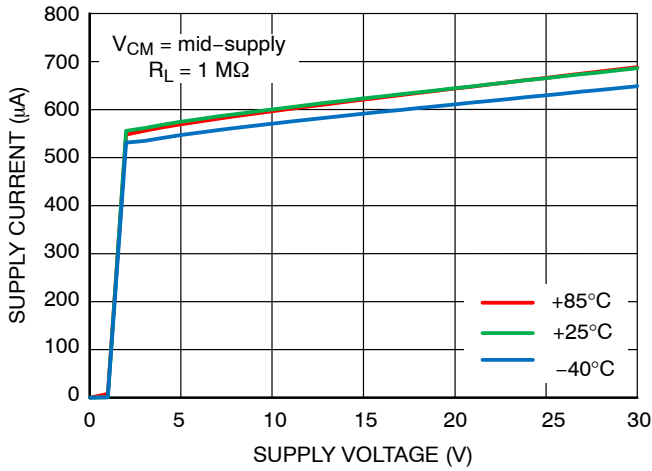

Figure 1. Supply Current vs. Supply Voltage

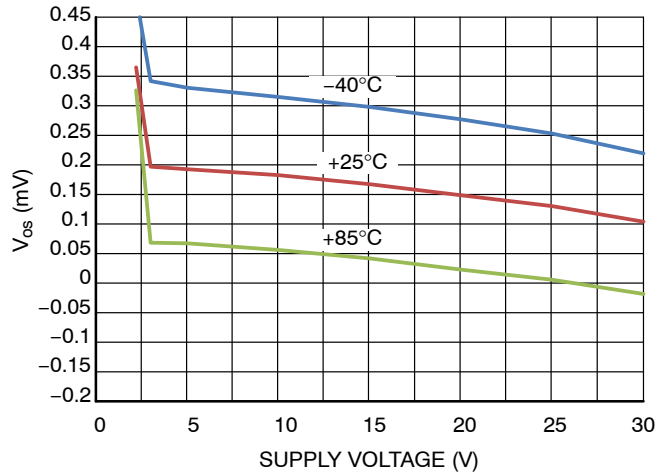

Figure 2.  $V_{OS}$  vs. Supply Voltage

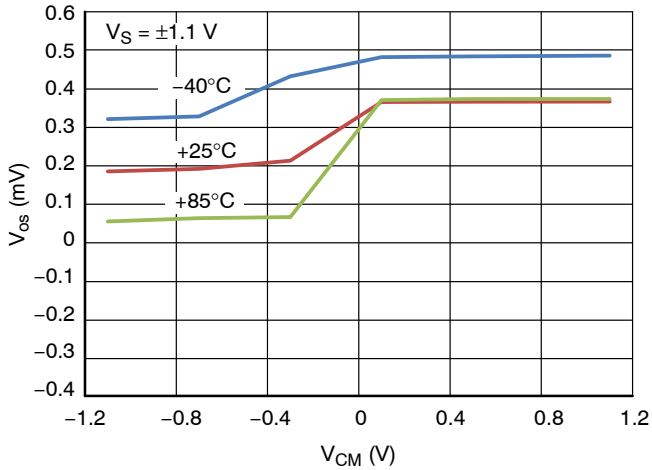

Figure 3.  $V_{OS}$  vs.  $V_{CM}$

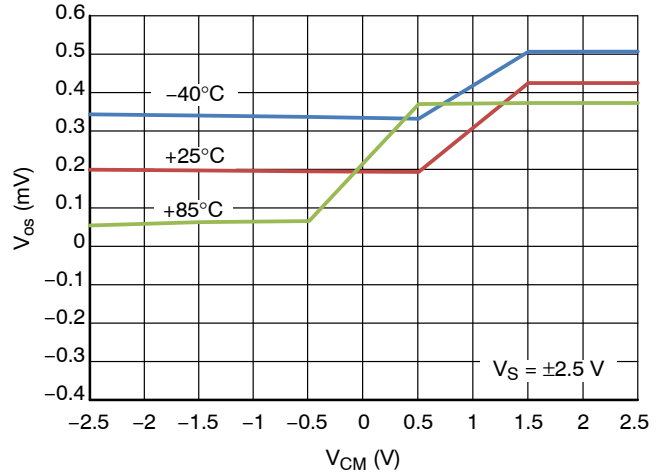

Figure 4.  $V_{OS}$  vs.  $V_{CM}$

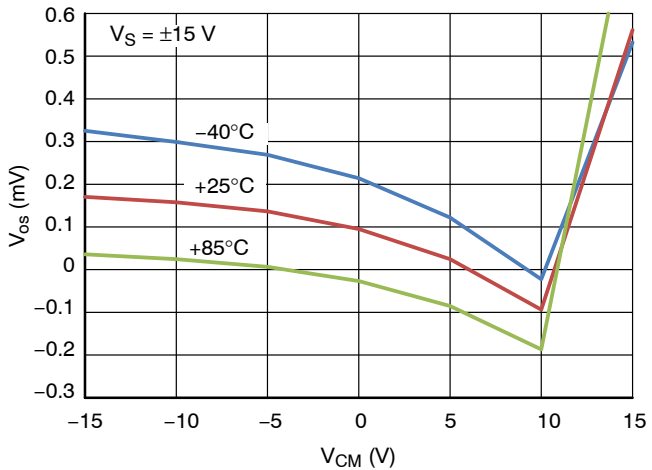

Figure 5.  $V_{OS}$  vs.  $V_{CM}$

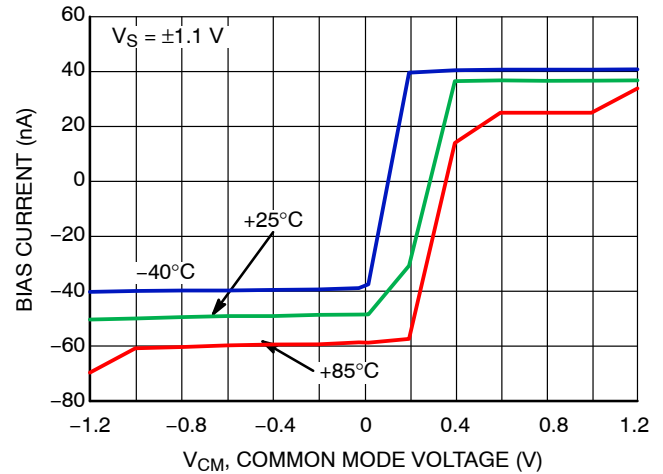

Figure 6. Inverting Input Bias Current vs. Common Mode

TYPICAL CHARACTERISTICS

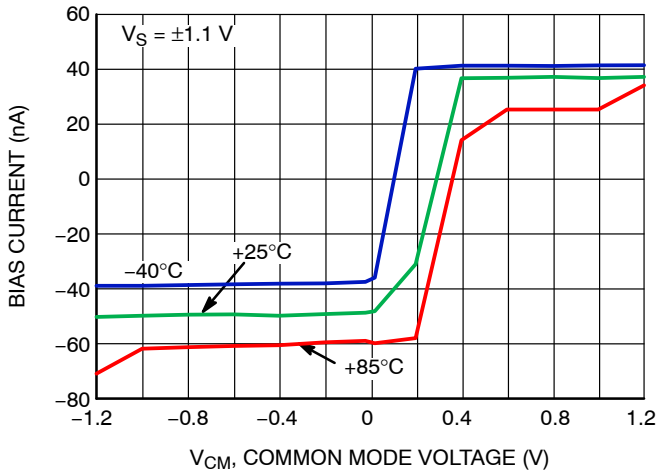

Figure 7. Non-Inverting Input Bias Current vs. Common Mode

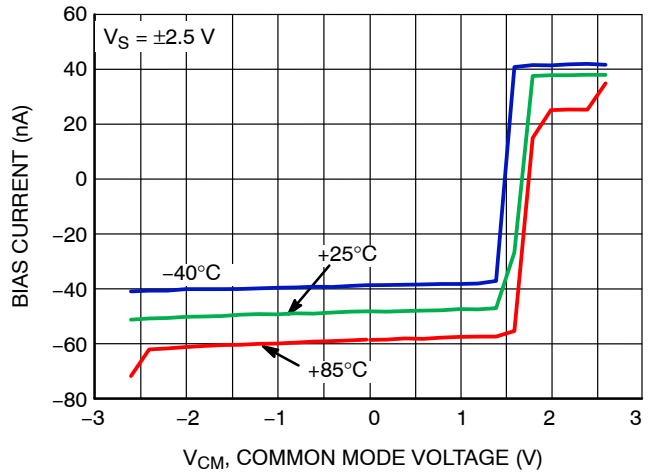

Figure 8. Inverting Input Bias Current vs. Common Mode

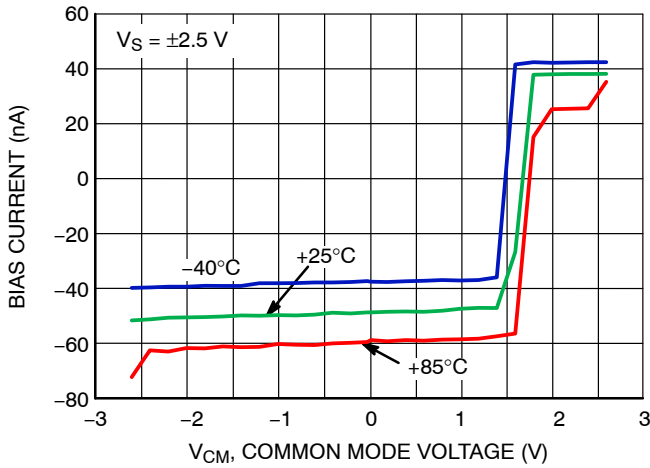

Figure 9. Non-Inverting Input Bias Current vs. Common Mode

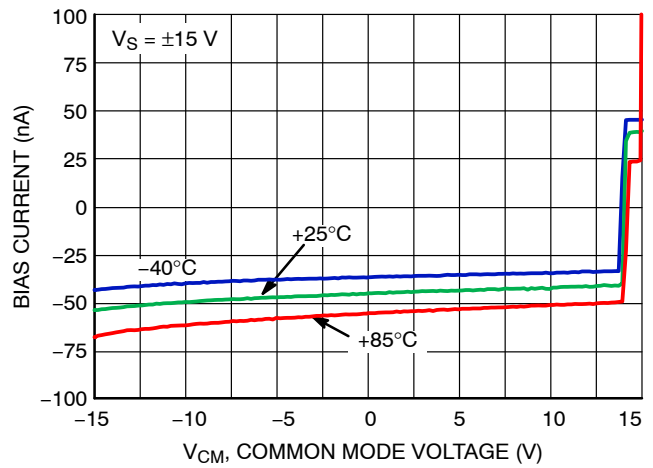

Figure 10. Inverting Input Bias Current vs. Common Mode

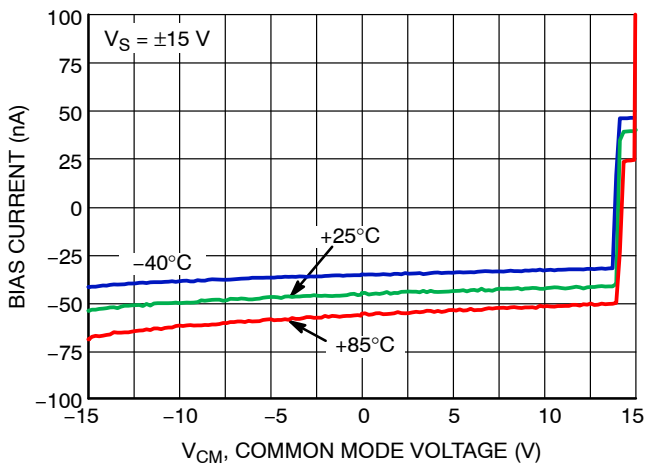

Figure 11. Non-Inverting Input Bias Current vs. Common Mode

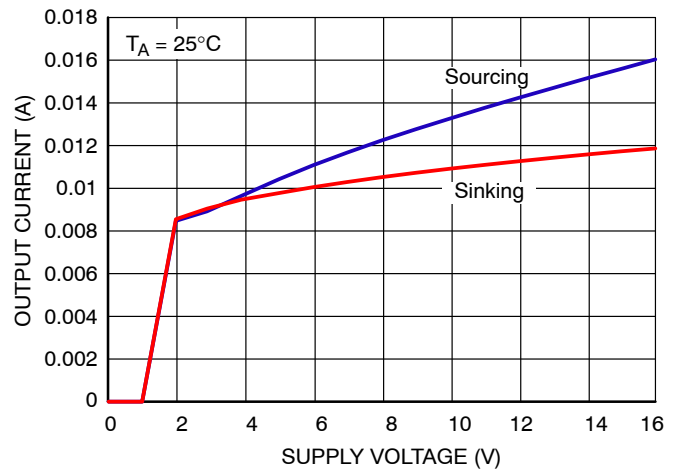

Figure 12. Short-Circuit Current vs. Supply Voltage

TYPICAL CHARACTERISTICS

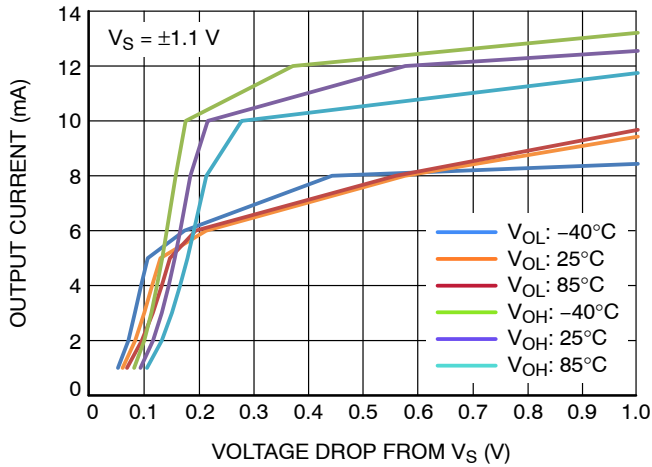

Figure 13.  $I_O$  vs.  $V_O$

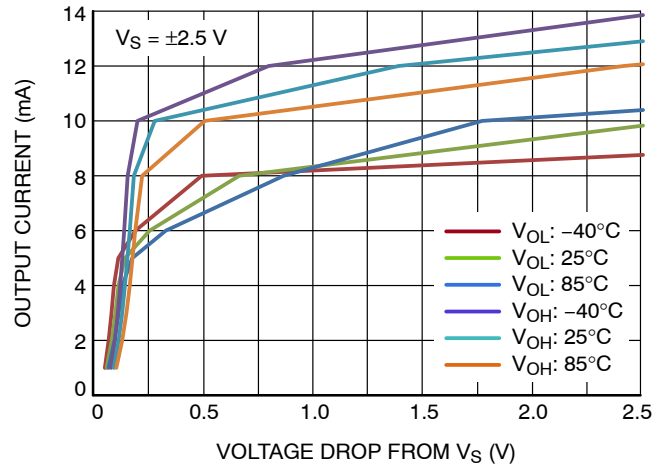

Figure 14.  $I_O$  vs.  $V_O$

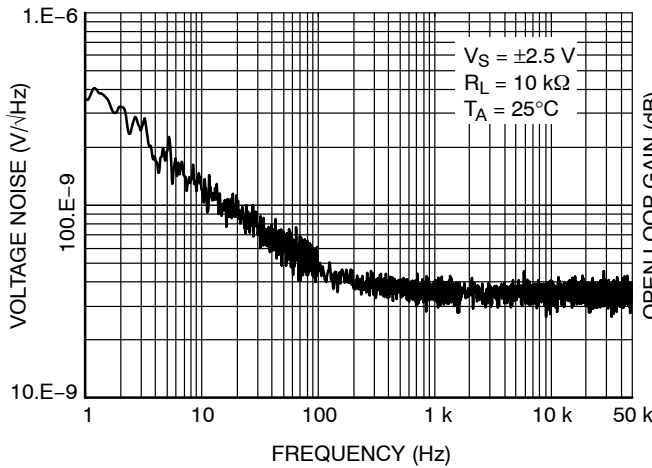

Figure 15. Voltage Noise vs. Frequency

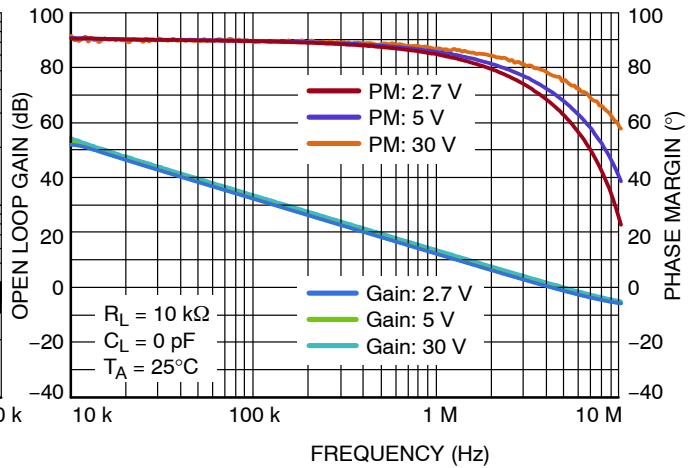

Figure 16. Gain and Phase Margin

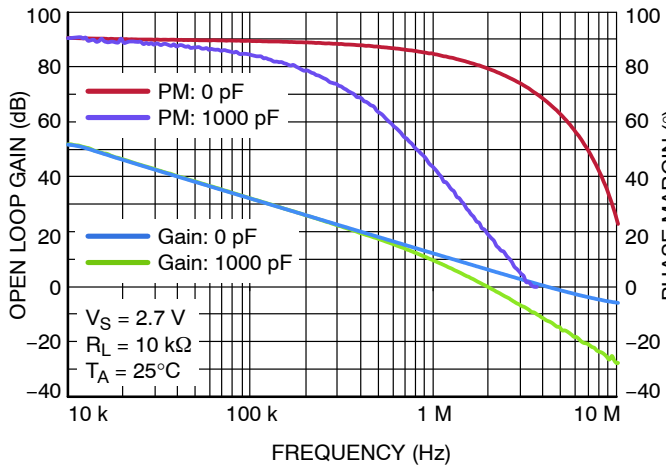

Figure 17. Gain/Phase vs. Capacitive Load

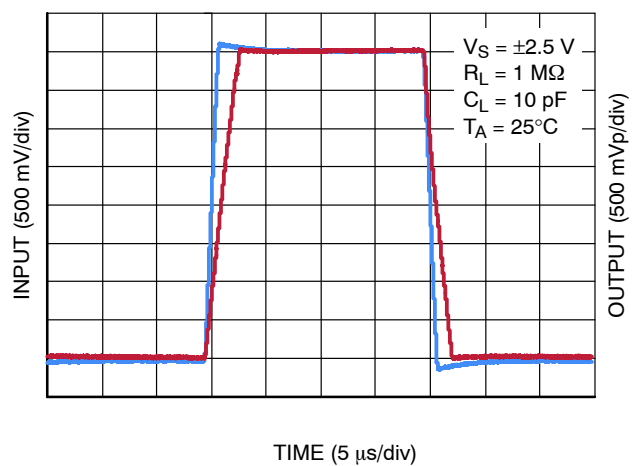

Figure 18. Large Signal Step Response



TYPICAL CHARACTERISTICS

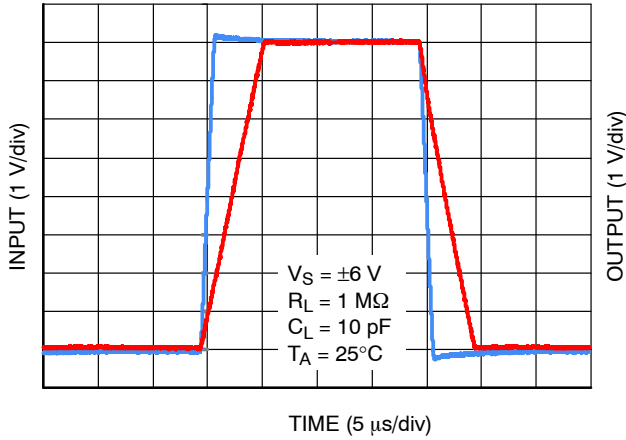

Figure 19. Large Signal Step Response

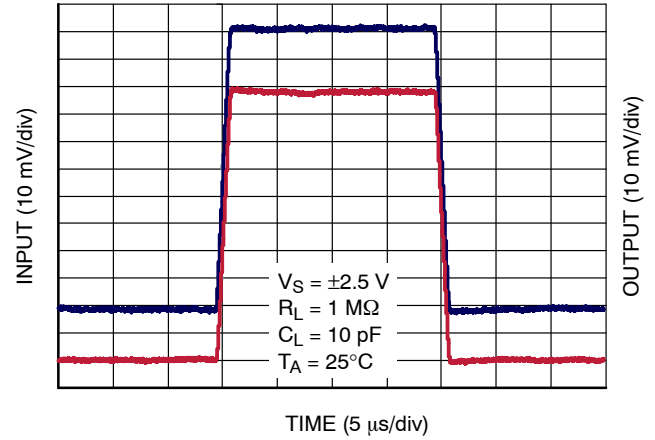

Figure 20. Small Signal Step Response

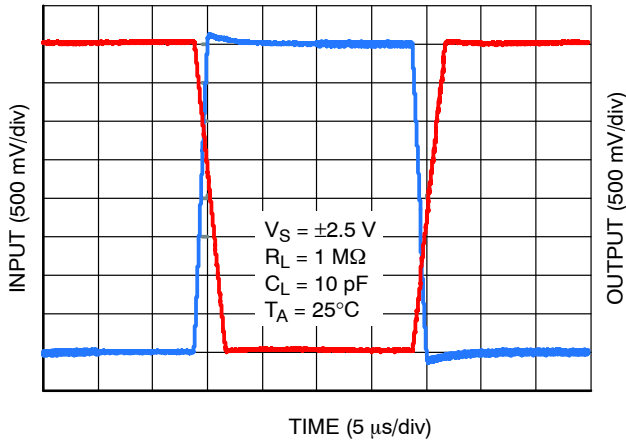

Figure 21. Inverting Large Signal Step Response

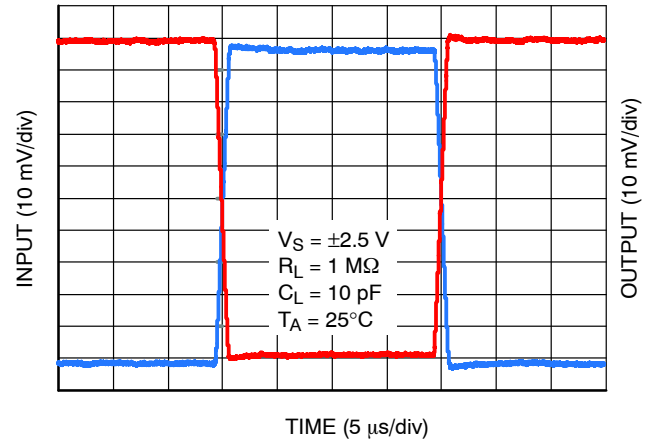

Figure 22. Inverting Small Signal Step Response

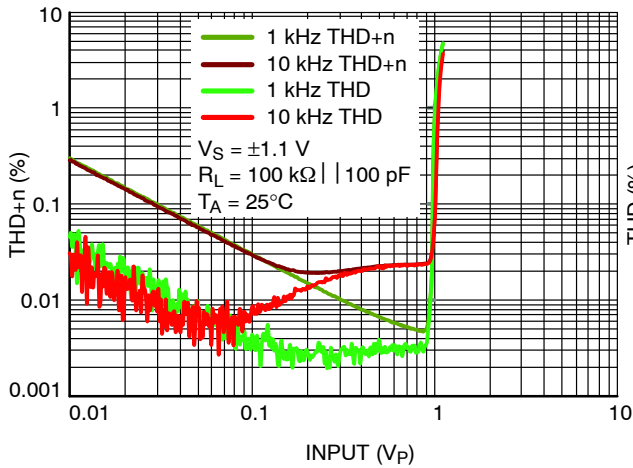

Figure 23. Harmonic Distortion

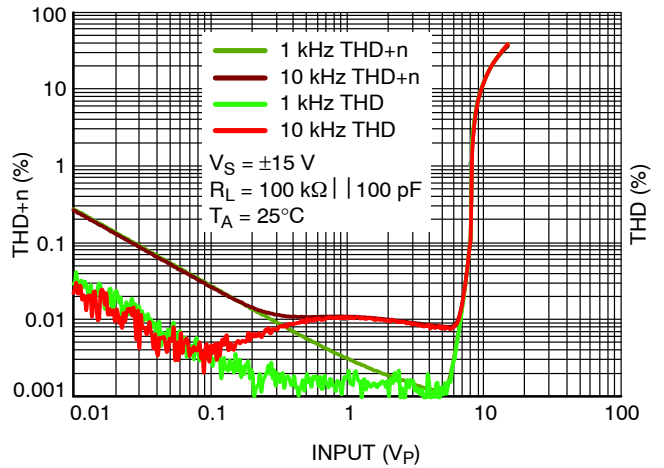

Figure 24. Harmonic Distortion

TYPICAL CHARACTERISTICS

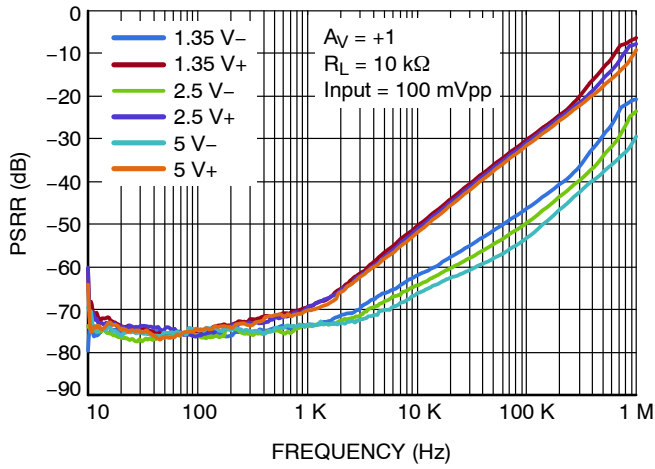

Figure 25. PSRR vs. Frequency

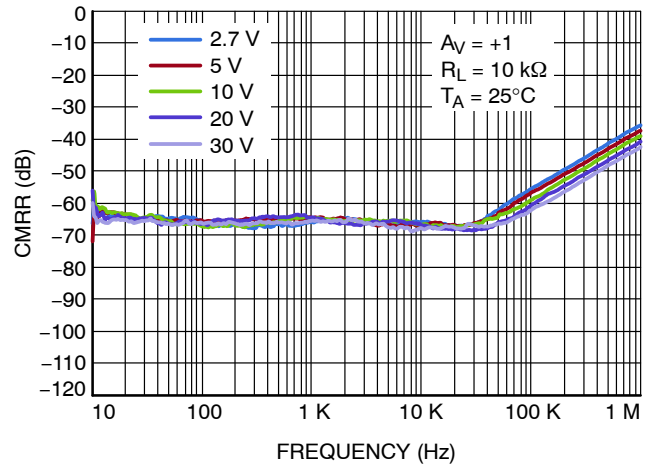

Figure 26. CMRR vs. Frequency

## APPLICATIONS INFORMATION

### GENERAL INFORMATION

The LM7301 is ideal in a variety of situations due to low supply current, wide bandwidth, wide input common mode range extending 100 mV beyond the rails, full rail-to-rail output, high capacitive load driving ability, wide supply voltage (1.8 V to 32 V), and low distortion. The high common mode rejection ratio and full rail-to-rail input range provides precision performance, particularly in non-inverting applications where the common mode error is added directly to the other system errors.

### CAPACITIVE LOAD DRIVING

The LM7301 is capable of driving large capacitive loads. A 1000 pF load only reduces the phase margin to about 25°.

### WIDE SUPPLY RANGE

High PSRR and CMRR provide precision performance when the LM7301 is operating on a battery or other unregulated supplies. This advantage is further enhanced by the very wide supply range of 1.8 V to 32 V. In situations where highly variable or unregulated supplies are present, the excellent PSRR and wide supply range will maintain this precision performance, even in such adverse supply conditions.

### SPECIFIC ADVANTAGES OF 5-Pin TSOP

The most apparent advantage of the 5-pin TSOP is that it can save board space, a critical aspect of any portable or miniaturized system design. The need to decrease the overall system size is inherent in any portable or lightweight system

application. Furthermore, the low profile can help in height limited designs, such as consumer hand-held remote controls, sub-notebook computers, and PCMCIA cards.

An additional advantage of the tiny TSOP-5 package is that it allows better system performance due to ease of package placement. Because the package is so small, it can fit on the board right where the op amp needs to be placed for optimal performance, unconstrained by the usual space limitations. This optimal placement allows for many system enhancements, which cannot be easily achieved with the constraints of a larger package. For example, problems such as system noise due picking up undesired digital signal can be easily reduced or mitigated. This pick-up problem is often caused by long wires in the board layout going to or from an op amp. By placing the tiny package closer to the signal source and allowing the LM7301 output to drive the long wire, the signal becomes less sensitive to such noise. An overall reduction of system noise results.

Often, trying to save space by using dual or quad op amps causes complicated board layouts due to the requirement of routing several signals to and from the same place on the board. Using the tiny op amp eliminates this problem.

### LOW DISTORTION, HIGH OUTPUT DRIVE CAPABILITY

The LM7301 offers excellent low distortion performance, with a THD+N of 0.02% at  $f = 10$  kHz. Low distortion levels are offered even at in scenarios with high output current and low load resistance.

## TYPICAL APPLICATIONS

### HANDHELD REMOTE CONTROLS

The LM7301 offers outstanding specifications for applications requiring balance between speed and power. In applications such as remote control operation, where high bandwidth and low power consumption are needed, the LM7301 performance can easily meet these requirements.

### OPTICAL LINE ISOLATION FOR MODEMS

The combination of low distortion and high load driving capabilities of the LM7301 make it an excellent choice in modems for driving opto-isolator circuits to achieve line isolation. This technique prevents telephone line noise from coupling onto the modem signal. Superior isolation is achieved by coupling the signal optically from the computer modem to the telephone lines; however, this also requires a

low distortion at relatively high currents. Due to its low distortion at high output drive currents, the LM7301 fulfills this need, in this as well as other telecom applications.

### REMOTE MICROPHONE IN PERSONAL COMPUTERS

Remote microphones in computers often utilize a microphone at the top of the monitor, which requires driving a long cable in a high noise environment. One method often used to reduce the noise is to lower the signal impedance to reduce the noise pickup. In this configuration, the amplifier usually requires 30 db to 40 db of gain, at bandwidths higher than most low-power CMOS parts can achieve. The LM7301 offers the tiny package, higher bandwidth, and large output drive capability necessary for this application.

### ORDERING INFORMATION

Device	Marking	Package	Shipping†
LM7301SN1T1G	JFG	SOT23-5 (Pb-Free)	3000 / Tape & Reel

†For information on tape and reel specifications, including part orientation and tape sizes, please refer to our Tape and Reel Packaging Specifications Brochure, BRD8011/D.

# MECHANICAL CASE OUTLINE PACKAGE DIMENSIONS

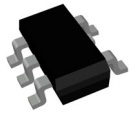

## TSOP-5 3.00x1.50x0.95, 0.95P CASE 483 ISSUE P

DATE 01 APR 2024

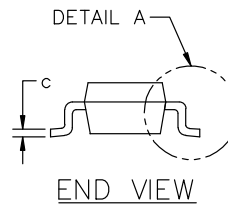
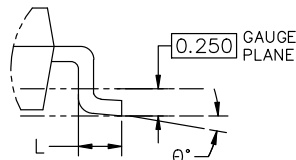
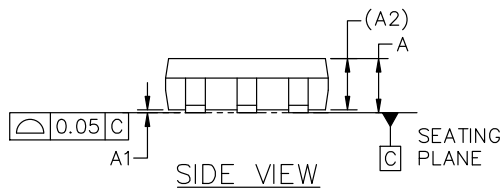
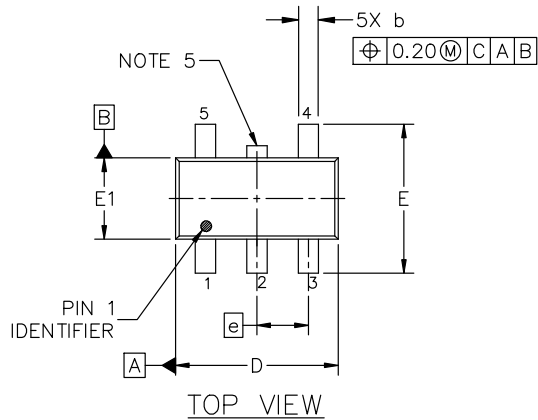

NOTES:

1. DIMENSIONING AND TOLERANCING CONFORM TO ASME Y14.5-2018.
2. ALL DIMENSION ARE IN MILLIMETERS (ANGLES IN DEGREES).
3. MAXIMUM LEAD THICKNESS INCLUDES LEAD FINISH THICKNESS. MINIMUM LEAD THICKNESS IS THE MINIMUM THICKNESS OF BASE MATERIAL.
4. DIMENSIONS D AND E1 DO NOT INCLUDE MOLD FLASH, PROTRUSIONS OF GATE BURRS. MOLD FLASH, PROTRUSIONS, OR GATE BURRS SHALL NOT EXCEED 0.15 PER SIDE. DIMENSION D.
5. OPTIONAL CONSTRUCTION: AN ADDITIONAL TRIMMED LEAD IS ALLOWED IN THIS LOCATION. TRIMMED LEAD NOT TO EXTEND MORE THAN 0.2 FROM BODY.

DIM	MILLIMETERS		
	MIN.	NOM.	MAX.
A	0.900	1.000	1.100
A1	0.010	0.055	0.100
A2	0.950 REF.		
b	0.250	0.375	0.500
c	0.100	0.180	0.260
D	2.850	3.000	3.150
E	2.500	2.750	3.000
E1	1.350	1.500	1.650
e	0.950 BSC		
L	0.200	0.400	0.600
θ	0°	5°	10°

### GENERIC MARKING DIAGRAM\*

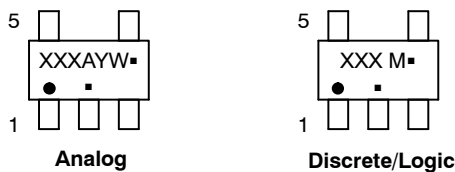

- XXX = Specific Device Code    XXX = Specific Device Code  
 A = Assembly Location        M = Date Code  
 Y = Year                            ▪ = Pb-Free Package  
 W = Work Week

▪ = Pb-Free Package  
(Note: Microdot may be in either location)

\*This information is generic. Please refer to device data sheet for actual part marking. Pb-Free indicator, "G" or microdot "▪", may or may not be present. Some products may not follow the Generic Marking.

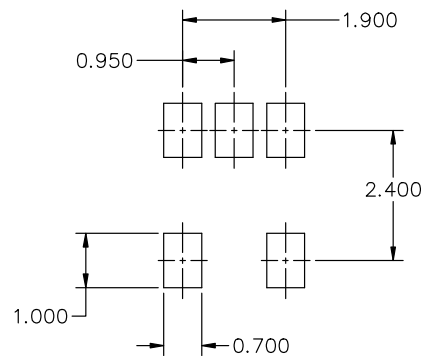

\* FOR ADDITIONAL INFORMATION ON OUR Pb-FREE STRATEGY AND SOLDERING DETAILS, PLEASE DOWNLOAD THE ON SEMICONDUCTOR SOLDERING AND MOUNTING TECHNIQUES REFERENCE MANUAL, SOLDERM/D.

<b>DOCUMENT NUMBER:</b>	<b>98ARB18753C</b>	Electronic versions are uncontrolled except when accessed directly from the Document Repository. Printed versions are uncontrolled except when stamped "CONTROLLED COPY" in red.
<b>DESCRIPTION:</b>	<b>TSOP-5 3.00x1.50x0.95, 0.95P</b>	<b>PAGE 1 OF 1</b>

onsemi and ONSEMI are trademarks of Semiconductor Components Industries, LLC dba onsemi or its subsidiaries in the United States and/or other countries. onsemi reserves the right to make changes without further notice to any products herein. onsemi makes no warranty, representation or guarantee regarding the suitability of its products for any particular purpose, nor does onsemi assume any liability arising out of the application or use of any product or circuit, and specifically disclaims any and all liability, including without limitation special, consequential or incidental damages. onsemi does not convey any license under its patent rights nor the rights of others.

**onsemi**, **Onsemi**, and other names, marks, and brands are registered and/or common law trademarks of Semiconductor Components Industries, LLC dba "**onsemi**" or its affiliates and/or subsidiaries in the United States and/or other countries. **onsemi** owns the rights to a number of patents, trademarks, copyrights, trade secrets, and other intellectual property. A listing of **onsemi**'s product/patent coverage may be accessed at [www.onsemi.com/site/pdf/Patent-Marking.pdf](http://www.onsemi.com/site/pdf/Patent-Marking.pdf). **onsemi** reserves the right to make changes at any time to any products or information herein, without notice. The information herein is provided "as-is" and **onsemi** makes no warranty, representation or guarantee regarding the accuracy of the information, product features, availability, functionality, or suitability of its products for any particular purpose, nor does **onsemi** assume any liability arising out of the application or use of any product or circuit, and specifically disclaims any and all liability, including without limitation special, consequential or incidental damages. Buyer is responsible for its products and applications using **onsemi** products, including compliance with all laws, regulations and safety requirements or standards, regardless of any support or applications information provided by **onsemi**. "Typical" parameters which may be provided in **onsemi** data sheets and/or specifications can and do vary in different applications and actual performance may vary over time. All operating parameters, including "Typicals" must be validated for each customer application by customer's technical experts. **onsemi** does not convey any license under any of its intellectual property rights nor the rights of others. **onsemi** products are not designed, intended, or authorized for use as a critical component in life support systems or any FDA Class 3 medical devices or medical devices with a same or similar classification in a foreign jurisdiction or any devices intended for implantation in the human body. Should Buyer purchase or use **onsemi** products for any such unintended or unauthorized application, Buyer shall indemnify and hold **onsemi** and its officers, employees, subsidiaries, affiliates, and distributors harmless against all claims, costs, damages, and expenses, and reasonable attorney fees arising out of, directly or indirectly, any claim of personal injury or death associated with such unintended or unauthorized use, even if such claim alleges that **onsemi** was negligent regarding the design or manufacture of the part. **onsemi** is an Equal Opportunity/Affirmative Action Employer. This literature is subject to all applicable copyright laws and is not for resale in any manner.

## ADDITIONAL INFORMATION

### TECHNICAL PUBLICATIONS:

Technical Library: [www.onsemi.com/design/resources/technical-documentation](http://www.onsemi.com/design/resources/technical-documentation)  
onsemi Website: [www.onsemi.com](http://www.onsemi.com)

### ONLINE SUPPORT: [www.onsemi.com/support](http://www.onsemi.com/support)

For additional information, please contact your local Sales Representative at [www.onsemi.com/support/sales](http://www.onsemi.com/support/sales)