



The Future of Analog IC Technology®

MagAlpha MA102

Motor Commutation Angle Sensor with UVW Multi-Pole Pair Emulation

DESCRIPTION

The MagAlpha MA102 magnetic sensor is an all-in-one solution designed to replace Hall switches for commutation in brushless DC motors and to provide absolute angle position. Absolute position is provided in the form of an 8-bit direct digital angle on the SPI interface. 12-bit resolution UVW commutation signals are provided with emulation for 1 to 8 pole pair rotors.

The MA102 detects the absolute angular position of a permanent magnet, typically a diametrically magnetized cylinder on a rotating shaft. Fast data acquisition and processing provide accurate angle measurement at speeds from 0 to 60,000 rpm.

The MA102 supports a wide range of magnetic field strengths and spatial configurations. Both end-of-shaft and off-axis (side-shaft mounting) configurations are supported.

FEATURES

- 12-Bit Repeatability of UVW Outputs
- Contactless Sensing for Long Life
- SPI Serial Interface for 8-Bit Angle Readout and Chip Configuration
- UVW Signals for Block Commutation with 1 to 8 Pole Pair Emulation Using a 2-Pole Magnet, Complement /UVW Signals Provided for Differential Signaling
- Programmable Magnetic Field Strength Detection for Diagnostic Checks
- Linearization for Side-Shaft Mounting
- 3.3V, 12mA Supply
- -40°C to +125°C Operating Temperature
- Available in a QFN-16 (3mmx3mm) Package

APPLICATIONS

- BLDC Motor Commutation Drives
- BLDC Motor Servo
- Motor Speed and Position Control

All MPS parts are lead-free, halogen-free, and adhere to the RoHS directive. For MPS green status, please visit MPS website under Quality Assurance. "MPS" and "The Future of Analog IC Technology" are registered trademarks of Monolithic Power Systems, Inc.

TYPICAL APPLICATION

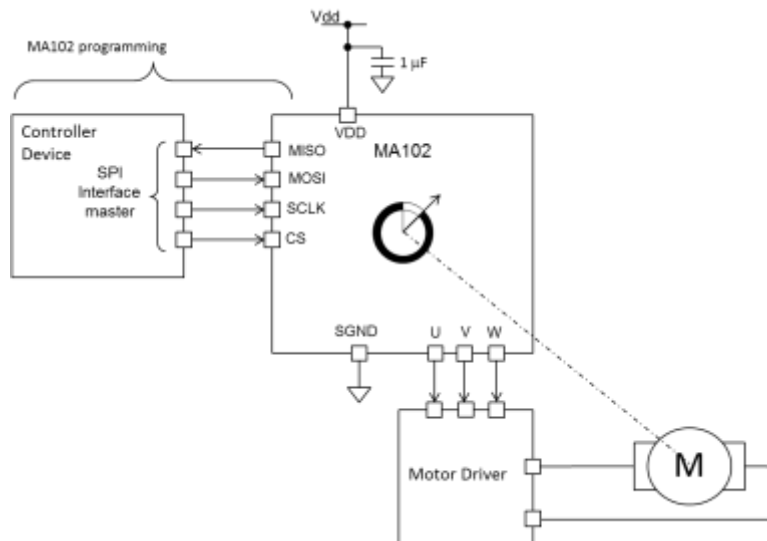

ORDERING INFORMATION

Part Number*	Package	Top Marking
MA102GQ	QFN-16 (3mmx3mm)	See Below

* For Tape & Reel, add suffix -Z (e.g. MA102GQ-Z)

TOP MARKING

AYXY
LLL

AYX: Product code of MA102GQ
 Y: Year code
 LLL: Lot number

PACKAGE REFERENCE

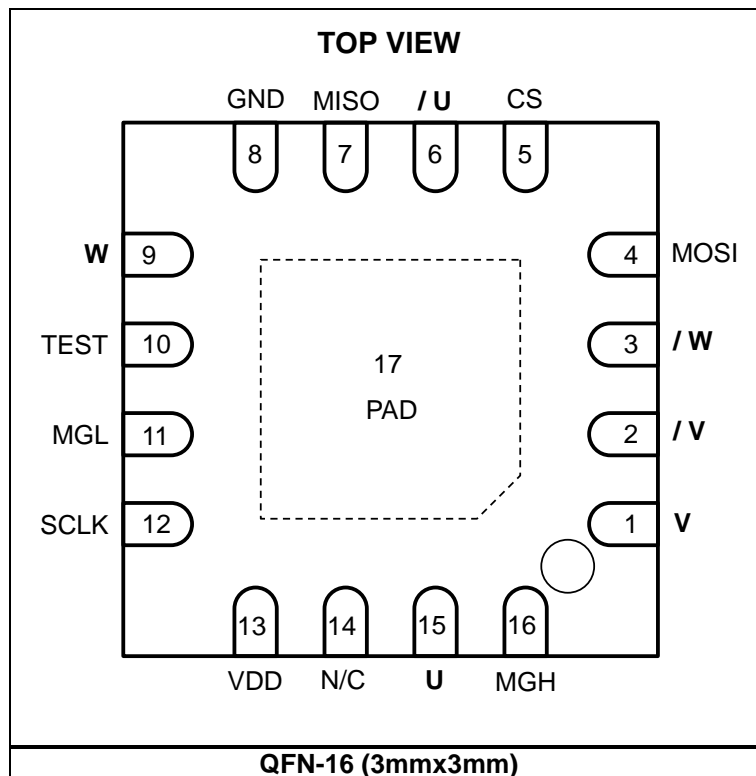

ABSOLUTE MAXIMUM RATINGS ⁽¹⁾

Supply voltage	-0.5V to +4.6V
Input pin voltage (V _I)	-0.5V to +6.0V
Output pin voltage (V _O)	-0.5V to +4.6V
Continuous power dissipation (T _A = +25°C) ⁽²⁾2.0W
Junction temperature	125°C
Lead temperature	260°C
Storage temperature.....	-65°C to 150°C

Thermal Resistance ⁽³⁾	θ_{JA}	θ_{JC}
QFN-16 (3mmx3mm)	50.....	12 ... °C/W

NOTES:

- 1) Exceeding these ratings may damage the device.
- 2) The maximum allowable power dissipation is a function of the maximum junction temperature T_J (MAX), the junction-to-ambient thermal resistance θ_{JA} , and the ambient temperature T_A. The maximum allowable continuous power dissipation at any ambient temperature is calculated by $P_D (MAX) = (T_J (MAX) - T_A) / \theta_{JA}$.
- 3) Measured on JESD51-7, 4-layer PCB.

ELECTRICAL CHARACTERISTICS

Parameter	Symbol	Condition	Min	Typ	Max	Units
Recommended Operating Conditions						
Supply voltage	VDD		3.0	3.3	3.6	V
Supply current	IDD	From -40°C to +125°C	10.2	11.7	13.8	mA
Operating temperature	Top		-40		125	°C
Applied magnetic field	B		30	60		mT

GENERAL CHARACTERISTICS

VDD = 3.3V, 45mT < B < 100mT, Temp = -40°C to +125°C, unless otherwise noted.

Parameter	Symbol	Condition	Min	Typ	Max	Units
Absolute Output – Serial						
Effective resolution		3 σ deviation of the noise distribution	8			bit
RMS noise			0.01	0.02	0.03	deg
Refresh rate			850	980	1100	kHz
Data output length			8		8	bit
Response Time						
Power-up time ⁽⁴⁾					12	ms
Latency ⁽⁵⁾		Constant speed propagation delay	8		10	μ s
Filter cut-off frequency ⁽⁴⁾	Fcutoff			390		Hz
Accuracy						
INL at 25°C		At room temperature over the full field range		0.7		deg
INL between -40°C to +125°C ⁽⁵⁾		Over the full temperature range and field range		1.1		deg
Output Drift						
Temperature induced drift at room temperature ⁽⁵⁾				0.015	0.04	deg/°C
Temperature induced variation ⁽⁵⁾		From 25°C to 85°C		0.5	1.2	deg
		From 25°C to 125°C		1.0	2.1	deg
Magnetic field induced ⁽⁵⁾				0.005		deg/mT
Voltage supply induced ⁽⁵⁾					0.3	deg/V
Incremental Output – UVW						
Cycle per turn	NPP		1		8	
UVW hysteresis ⁽⁵⁾	H				0.7	deg
UVW jitter (3 σ) ⁽⁵⁾				0.1	0.3	deg
Magnetic Field Detection Thresholds						
Accuracy ⁽⁵⁾				5		mT
Hysteresis ⁽⁵⁾	MagHys			6		mT
Temperature drift ⁽⁵⁾				-600		ppm/°C
Digital I/O						
Input high voltage	V _{IH}		2.5		5.5	V
Input low voltage	V _{IL}		-0.3		0.8	V
Output low voltage ⁽⁵⁾	V _{OL}	I _{OL} = 4mA			0.4	V
Output high voltage ⁽⁵⁾	V _{OH}	I _{OH} = 4mA	2.4			V
Pull-down resistor	R _{PD}		43	55	97	k Ω
Rising edge slew rate ⁽⁴⁾	T _R	CL = 50pF		0.7		V/ns
Falling edge slew rate ⁽⁴⁾	T _F	CL = 50pF		0.7		V/ns

NOTES:

4) Guaranteed by design.

5) Guaranteed by characteristic test.

TYPICAL CHARACTERISTICS

VDD = 3.3V, Temp = 25°C, unless otherwise noted.

Current Consumption at VDD = 3.3V

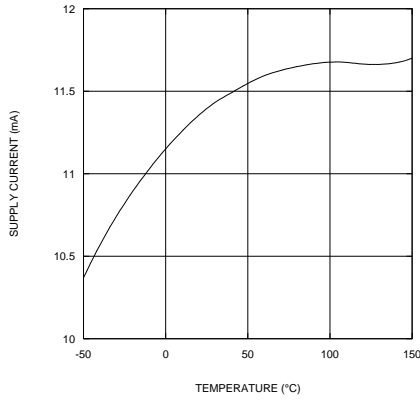

Noise Spectrum at 50mT

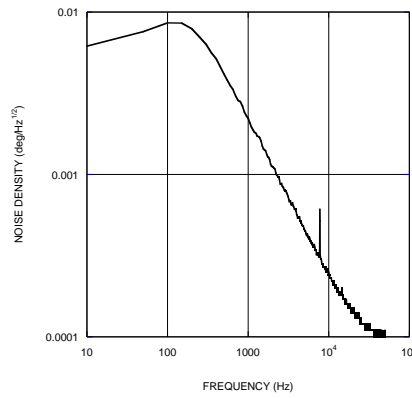

Filter Transfer Function

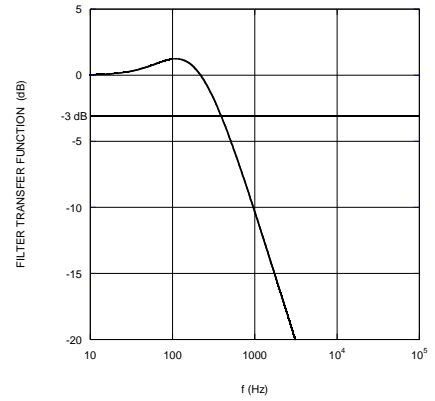

Error Curves at 50mT

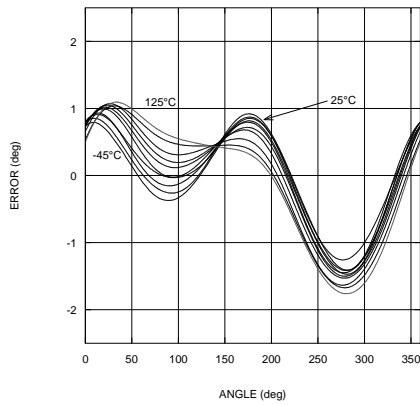

Non-Linearity (INL and harmonics)

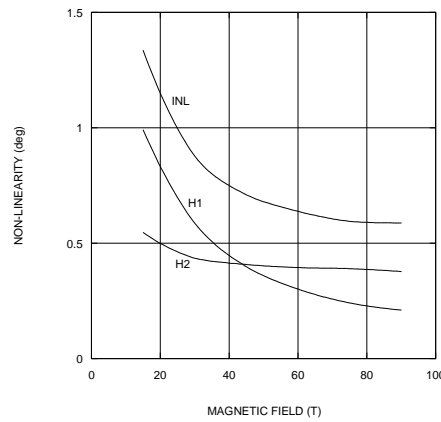

RMS Noise

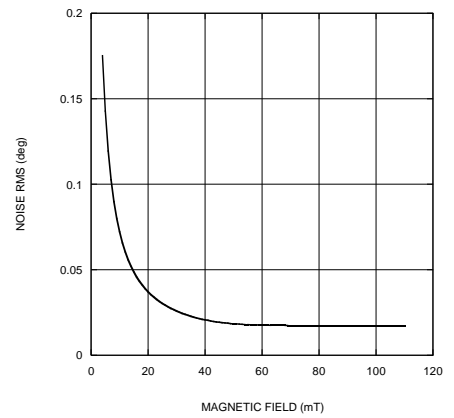

PIN FUNCTIONS

Package Pin #	Name	Description
1	V	Motor commutation output.
2	/V	Motor commutation output, complement.
3	/W	Motor commutation output, complement.
4	MOSI	Data in (SPI). MOSI has an internal pull-down resistor.
5	CS	Chip select (SPI). CS has an internal pull-up resistor.
6	/U	Motor commutation output, complement.
7	MISO	Data out (SPI). MISO has an internal pull-down resistor that is enabled at a high impedance state.
8	GND	Supply ground.
9	W	Motor commutation output.
10	TEST	Connect to ground.
11	MGL	Digital output indicating field strength below MGLT level.
12	SCLK	Clock (SPI). SCLK has an internal pull-down resistor.
13	VDD	Supply 3.3V.
14	N/C	No connection. Leave N/C unconnected.
15	U	Motor commutation output.
16	MGH	Digital output indicating field strength above MGHT level.

BLOCK DIAGRAM

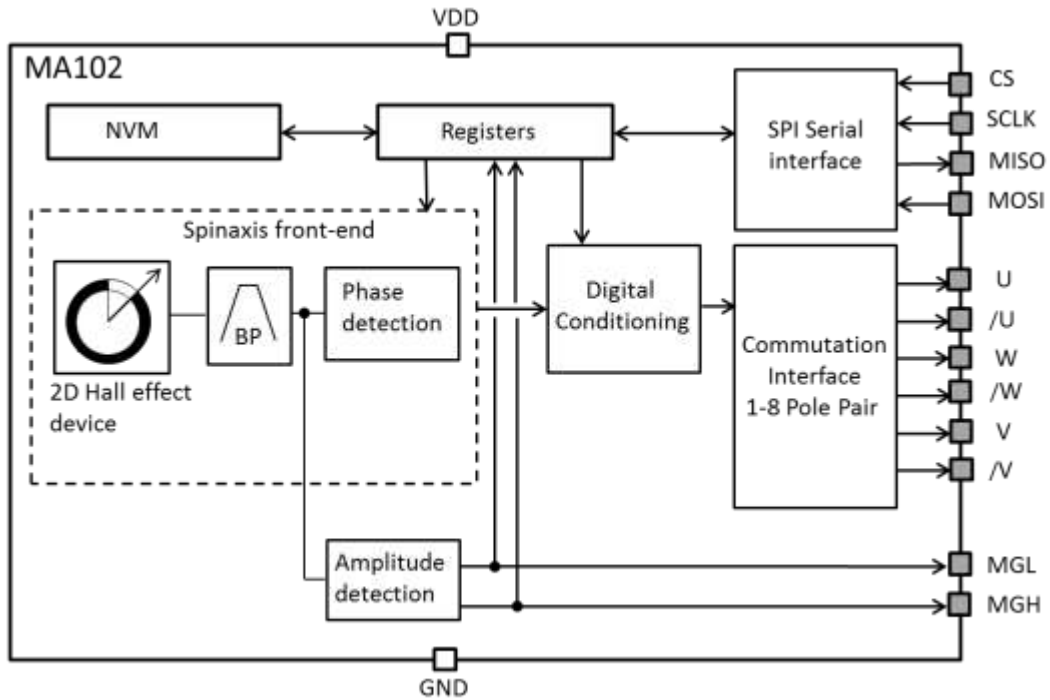

Figure 1: Functional Block Diagram

OPERATION

Sensor Front-End

The magnetic field is detected with integrated Hall devices located in the center of the package. The angle is measured using the *Spinaxis™* method, which directly digitizes the direction of the field without complex arctangent computation or feedback loop-based circuits (interpolators).

The *Spinaxis™* method is based on phase detection and generates a sinusoidal signal with a phase that represents the angle of the magnetic field. The angle is then obtained by a time-to-digital converter, which measures the time between the zero crossing of the sinusoidal signal and the edge of a constant waveform (see Figure 2). The time-to-digital is output from the front-end to the digital conditioning block.

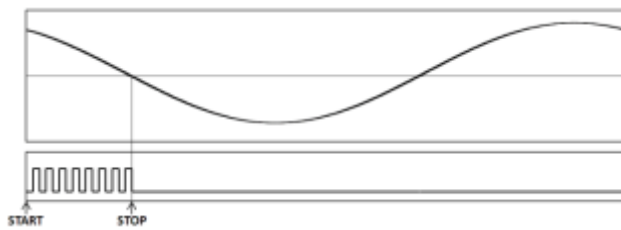

Top: Sine Waveform

Bottom: Clock of Time-to-Digital Converter

Figure 2: Phase Detection Method

The output of the front-end delivers a digital number proportional to the angle of the magnetic field at the rate of 1MHz in a straightforward and open-loop manner.

Digital Filtering

The front-end signal is further treated to achieve the final effective resolution. This treatment does not add any latency in steady conditions. The filter transfer function can be calculated with Equation (1):

$$H(s) = \frac{1 + 2\tau s}{(1 + \tau s)^2} \quad (1)$$

Where τ is the filter time constant, related to the cutoff frequency by $\tau = 0.38/F_{cutoff}$. See the General Characteristics table on page 5 for the value of *Fcutoff*.

Sensor – Magnet Mounting

The sensitive volume of the MA102 is confined in a region less than 100µm wide and has multiple integrated Hall devices. This volume is located both horizontally and vertically within 50µm of the center of the QFN package. The sensor detects the angle of the magnetic field projected in a plane parallel to the package's upper surface. This means that the only relevant magnetic field is the in-plane component (X and Y components) in the middle point of the package.

By default, when looking at the package top, the angle increases when the magnetic field rotates clockwise. Figure 3 shows the zero angle of the unprogrammed sensor, where the cross indicates the sensitive point. Both the rotation direction and the zero angle can be programmed.

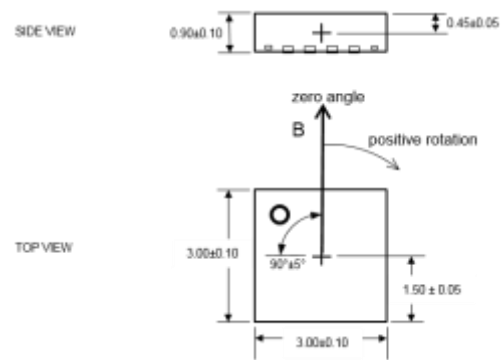
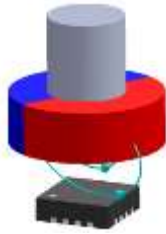
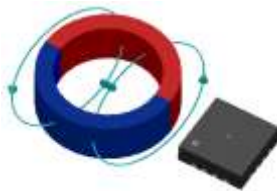

Figure 3: Detection Point and Default Positive Direction

This type of detection provides flexibility for the design of an angular encoder. The sensor only requires the magnetic vector to lie essentially within the sensor plane with a field amplitude of at least 30mT. Note that the MA102 can work with fields smaller than 30mT, but the linearity and resolution performance may deviate from the specifications. The most straightforward mounting method is to place the MA102 sensor on the rotation axis of a permanent magnet (i.e.: a diametrically magnetized cylinder) (see Figure 4). A typical magnet is a Neodymium alloy (N35) cylinder with dimensions Ø5x3mm inserted into an aluminum shaft and with an air gap between the magnet and the sensor (surface of package) of 1.5mm. For good linearity, the sensor is positioned with a precision of 0.5mm.

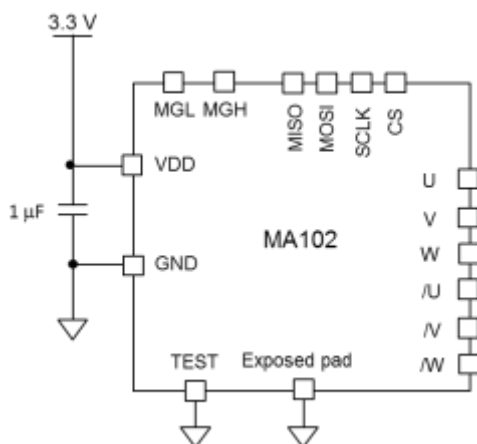

Figure 4: End-of-Shaft Mounting

If the end-of-shaft position is not available, the sensor can be positioned away from the rotation axis of a cylinder or ring magnet (see Figure 5). In this case, the magnetic field angle is no longer directly proportional to the mechanical angle. The MA102 can be adjusted to compensate for this effect and recover the linear relation between the mechanical angle and the sensor output. With multiple pole pair magnets, the MA102 indicates multiple rotations for each mechanical turn.

Figure 5: Side-Shaft Mounting

Electrical Mounting and Power Supply Decoupling

It is recommended to place a 1 μ F decoupling capacitor close to the sensor with a low impedance path to GND (see Figure 6).

Figure 6: Connection for Supply Decoupling

Generally, the MagAlpha works fine with or without the exposed pad connected to anything. For optimum conditions (electrically, thermally, and mechanically), it is recommended that the exposed pad be connected to ground.

Serial Interface

The sensor supports the SPI serial interface for angle reading and register programming.

SPI

SPI is a 4-wire, synchronous, serial communication interface. The MagAlpha supports SPI Mode 3 and Mode 0 (see Table 1 and Table 2). The SPI Mode (0 or 3) is detected automatically by the sensor and therefore does not require any action from the user. The maximum clock rate supported on SPI is 25MHz. There is no minimum clock rate. Note that real life data rates depend on PCB layout quality and signal trace length. See Figure 7, Figure 8, and Table 3 for SPI timing.

All commands to the MagAlpha (whether for writing or reading register content) must be transferred through the SPI MOSI pin and must be 16 bits long. See the SPI Communication section on page 13 for details.

Table 1: SPI Specification

	Mode 0	Mode 3
SCLK idle state	Low	High
Data capture	On SCLK rising edge	
Data transmission	On SCLK falling edge	
CS idle state	High	
Data order	MSB first	

Table 2: SPI Standard

	Mode 0	Mode 3
CPOL	0	1
CPHA	0	1
Data Order (DORD)	0 (MSB first)	

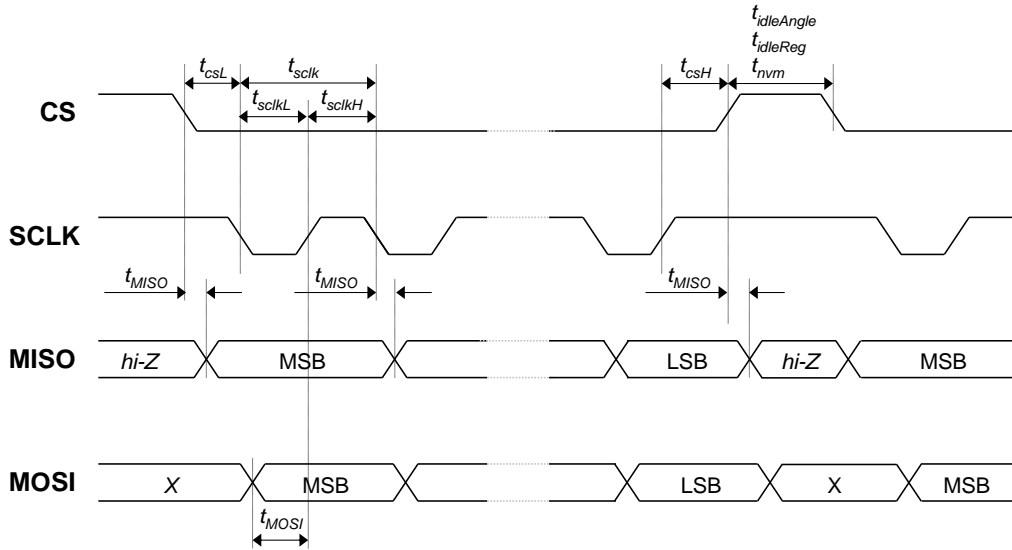
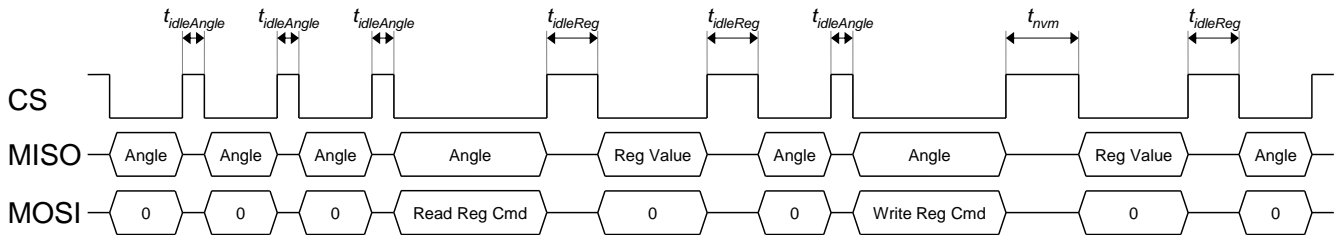
Figure 7: SPI Timing Diagram

Figure 8: Minimum Idle Time
Table 3: SPI Timing

Parameter ⁽⁶⁾	Description	Min	Max	Unit
$t_{idleAngle}$	Idle time between two subsequent angle transmissions	150		ns
$t_{idleReg}$	Idle time before and after a register readout	750		ns
t_{nvm}	Idle time between a write command and a register readout (delay necessary for non-volatile memory update)	20		ms
t_{csL}	Time between CS falling edge and SCLK falling edge	80		ns
t_{sclk}	SCLK period	40		ns
t_{sclkL}	Low level of SCLK signal	20		ns
t_{sclkH}	High level of SCLK signal	20		ns
t_{csH}	Time between SCLK rising edge and CS rising edge	25		ns
t_{MISO}	SCLK setting edge to data output valid		15	ns
t_{MOSI}	Data input valid to SCLK reading edge	15		ns

NOTE:

6) All values are guaranteed by design.

SPI Communication

The sensor supports three types of SPI operation:

- Read angle
- Read configuration register
- Write configuration register

Each operation has a specific frame structure described below.

SPI Read Angle

Every 1µs, new data is transferred into the output buffer. The master device triggers the reading by pulling CS low.

When a trigger event is detected, the data remains in the output buffer until the CS signal is de-asserted (see Table 4).

Table 4: Sensor Data Timing

Event	Action
CS falling edge	Start reading and freeze output buffer
CS rising edge	Release of the output buffer

See Figure 9 for a diagram of a full SPI angle reading. See Figure 10 for a diagram of a partial SPI angle reading. A full angle reading requires 16 clock pulses. The sensor MISO line returns:

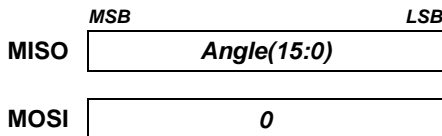

The MagAlpha family has sensors with different features and levels of resolution. Check the data output length in the General Characteristics table on page 5 for the number of useful bits delivered at the serial output. If the data length is smaller than 16, the rest of bits sent are zeros.

For example, a data output length of 12 bits means that the serial output delivers a 12-bit angle value with four bits of zeros padded at the end (MISO state remains zero). If the master sends 16 clock counts, the MagAlpha replies with:

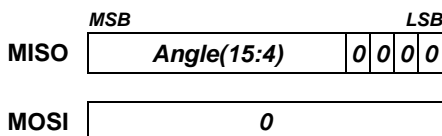

Angle reading can be therefore optimized without any loss of information by reducing the number of clock counts. In the case of a 12-bit data output length, only 12 clock counts are required to get the full sensor resolution.

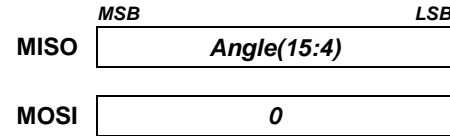

If less resolution is needed, the angle can be read by sending even fewer clock counts (since MSB is first).

In case of fast reading, the MagAlpha keeps sending the same data until the data is refreshed (see the refresh rate in the General Characteristics table).

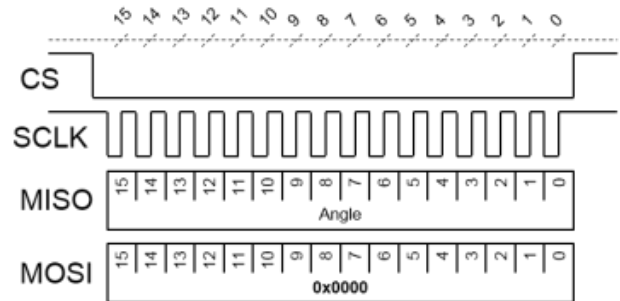

Figure 9: Diagram of a Full 16-Bit SPI Angle Reading

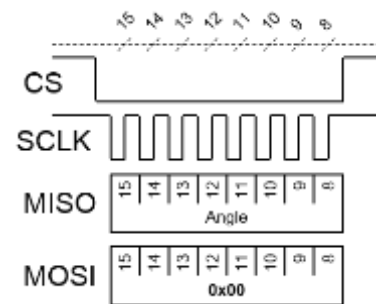
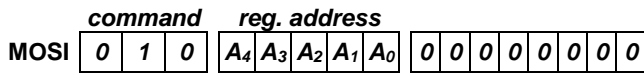
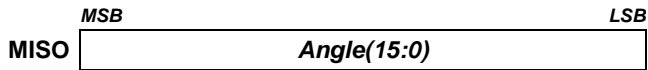

Figure 10: Diagram of a Partial 8-Bit SPI Angle Reading

SPI Read Register

A read register operation is constituted of two 16-bit frames. The first frame sends a read request which contains the 3-bit read command (010) followed by the 5-bit register address. The last eight bits of the frame must be all set to zero. The second frame returns the 8-bit register value (MSB byte).

The first 16-bit SPI frame (read request) is:



The second 16-bit SPI frame (response) is:

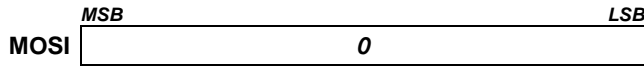
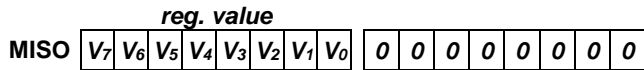

See Figure 11 for a complete transmission overview.

For example, to get the value of the magnetic level high and low flags (MGH and MGL). Read register 27 (bit 6, bit 7) by sending the following first frame:

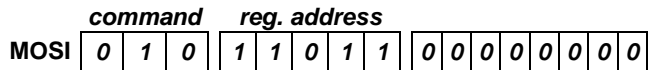
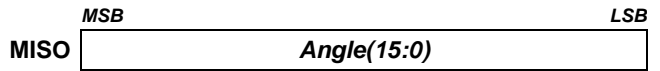

In the second frame, the MagAlpha replies:

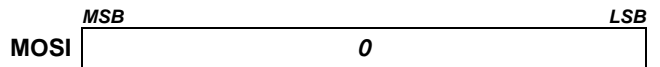
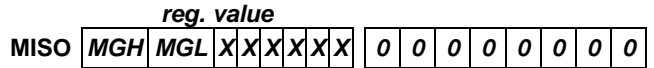

See Figure 12 for a complete example overview.

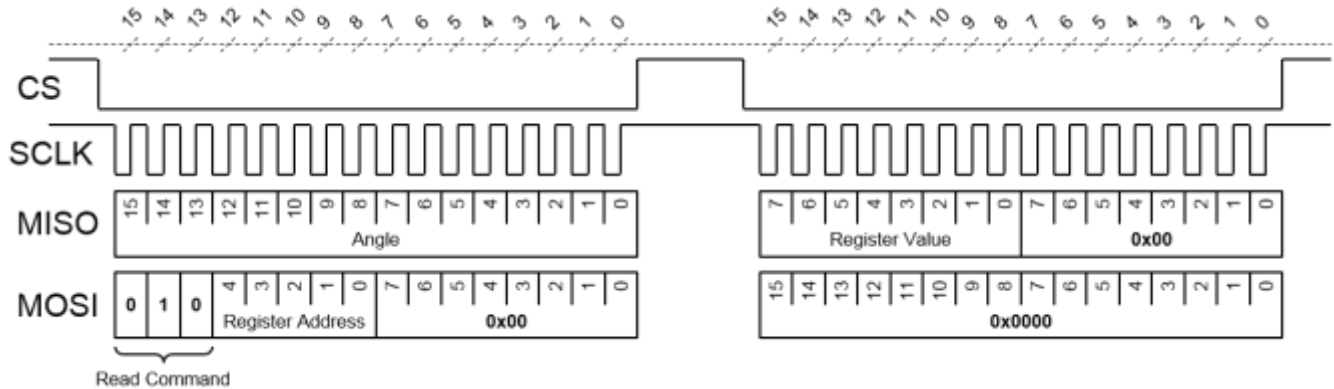

Figure 11: Two 16-Bit Frames Read Register Operation

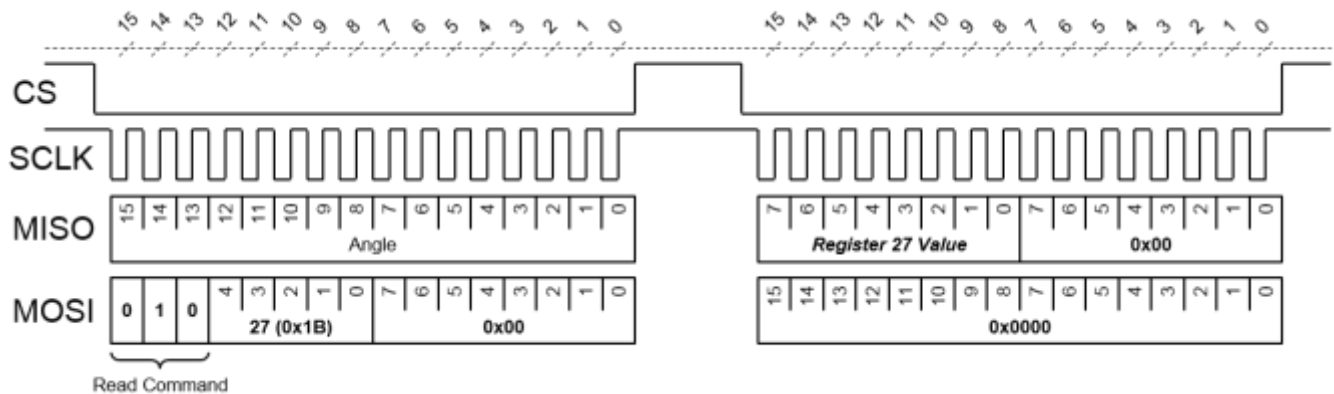

Figure 12: Example Read Magnetic Level Flags High and Low (MGH, MGL) on Register 27, Bit 7-6

SPI Write Register

Table 5 shows the programmable 8-bit registers. Data written to these registers are stored in the on-chip non-volatile memory and reloaded automatically during power on. The factory default register values are shown in Table 6.

A write register operation is constituted of two 16-bit frames. The first frame sends a write request which contains the 3-bit write command (100) followed by the 5-bit register address and the 8-bit value (MSB first). The second frame returns the newly written register value (acknowledge).

The on-chip memory is guaranteed to endure 1,000 write cycles at 25°C.

It is important to wait 20ms between the first and the second frame. This is the time taken to write the non-volatile memory. Failure to implement this wait period results in the register's previous value being read. Note that this delay is only required after a write request. A read register request and read angle do not require this wait time.

The first 16-bit SPI frame (write request) is:

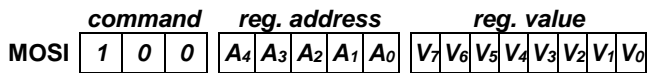
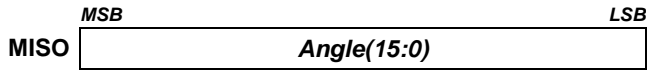

The second 16-bit SPI frame (response) is:

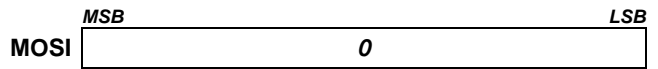
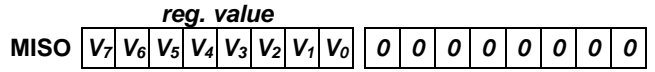

The read-back register content can be used to verify the register programming. See Figure 13 for a complete transmission overview.

For example, to set the value of the output rotation direction (RD) to counterclockwise (high), write register 9 by sending the following first frame:

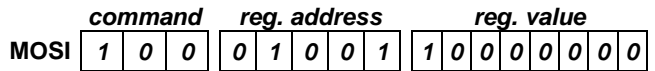
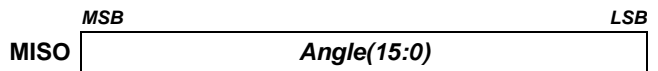

Send the second frame after a 20ms wait time. If the register is correctly written, the reply is:

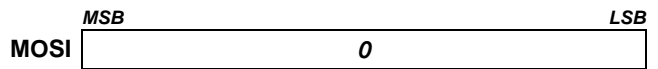
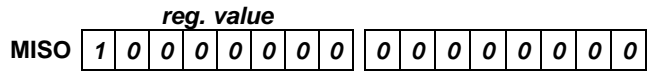

See Figure 14 for a complete example.

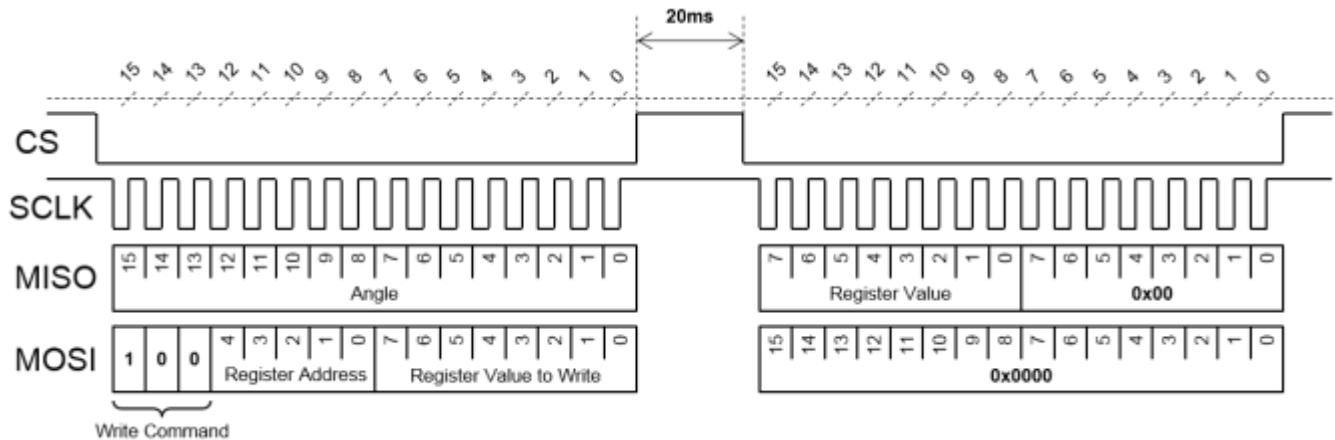

Figure 13: Overview of Two 16-Bit Frames Write Register Operation

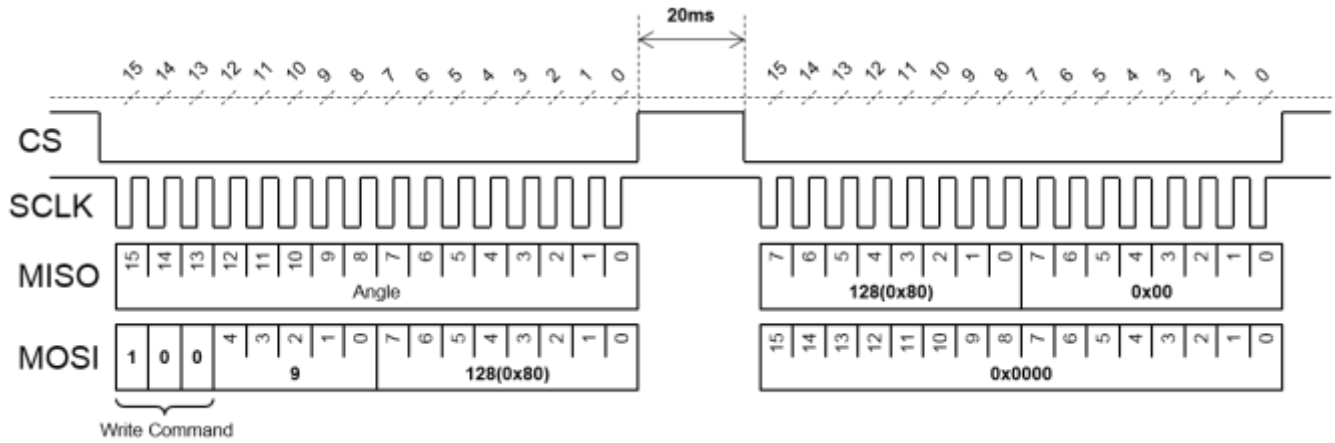

Figure 14: Example Write Output Rotation Direction (RD) to Counterclockwise (High), on Register 9, Bit 7

REGISTER MAP
Table 5: Register Map

No	Hex	Bin	Bit 7 MSB	Bit 6	Bit 5	Bit 4	Bit 3	Bit 2	Bit 1	Bit 0 LSB
0	0x0	00000	Z(7:0)							
1	0x1	00001	Z(15:8)							
2	0x2	00010	BCT(7:0)							
3	0x3	00011	-	-	-	-	-	-	ETY	ETX
6	0x6	00110	MGLT(2:0)			MGHT(2:0)			-	-
7	0x7	00111	NPP(2:0)			-	-	-		
9	0x9	01001	RD	-	-	-	-	-	-	-
27	0x1B	11011	MGH	MGL	-	-	-	-	-	-

Table 6: Factory Default Values

No	Hex	Bin	Bit 7 MSB	Bit 6	Bit 5	Bit 4	Bit 3	Bit 2	Bit 1	Bit 0 LSB
0	0x0	00000	0	0	0	0	0	0	0	0
1	0x1	00001	0	0	0	0	0	0	0	0
2	0x2	00010	0	0	0	0	0	0	0	0
3	0x3	00011	0	0	0	0	0	0	0	0
6	0x6	00110	0	0	0	1	1	1	0	0
7	0x7	00111	0	0	0	0	0	0	0	0
9	0x9	01001	0	0	0	0	0	0	0	0

Table 7: Programming Parameters

Parameters	Symbol	Number of Bits	Description	See Table
Zero setting	Z	16	Sets the zero position.	8
Bias current trimming	BCT	8	For side-shaft configuration: reduces the bias current of the X or Y Hall device.	11
Enable trimming X	ETX	1	Biased current trimmed in the X-direction Hall device.	12
Enable trimming Y	ETY	1	Biased current trimmed in the Y-direction Hall device.	12
Magnetic field high threshold	MGHT	3	Sets the field strength high threshold.	14
Magnetic field low threshold	MGLT	3	Sets the field strength low threshold.	14
Number of pole pairs	NPP	3	UVW cycles per turn for motor commutation.	15
Rotation direction	RD	1	Determines the sensor positive direction.	10

REGISTER SETTINGS

Zero Setting

The zero position of the MagAlpha (a_0) can be programmed with 16 bits of resolution. The angle streamed out by the MagAlpha (a_{out}) is given by Equation (2):

$$a_{out} = a_{raw} - a_0 \quad (2)$$

Where a_{raw} is the raw angle provided by the MagAlpha front end.

The parameter Z(15:0), which is zero by default, is the complementary angle of the zero setting. In decimals, it can be written as shown in Equation (3):

$$a_0 = 2^{16} - Z(15:0) \quad (3)$$

Table 8 shows the zero setting parameter.

Table 8: Zero Setting Parameter

Z(15:0)	Zero pos. a_0 (16 bit dec)	Zero pos. a_0 (deg)
0	65536	360.000
1	65535	359.995
2	65534	359.989
...
65534	2	0.011
65535	1	0.005

Example

To set the zero position to 20 degrees, the Z(15:0) parameter shall be equal to the complementary angle and can be calculated with Equation (4):

$$Z(15:0) = 2^{16} - \frac{20 \text{ deg}}{360 \text{ deg}} 2^{16} = 61895 \quad (4)$$

In binary, it is written as 1111 0001 1100 0111.

Table 9 shows the content of the registers 0 and 1.

Table 9: Register Content

Reg	Bit 7	Bit 6	Bit 5	Bit 4	Bit 3	Bit 2	Bit 1	Bit 0
0	1	1	0	0	0	1	1	1
1	1	1	1	1	0	0	0	1

Rotation Direction

By default, when looking at the top of the package, the angle increases when the magnetic field rotates clockwise (CW) (see Figure 15 and Table 10).

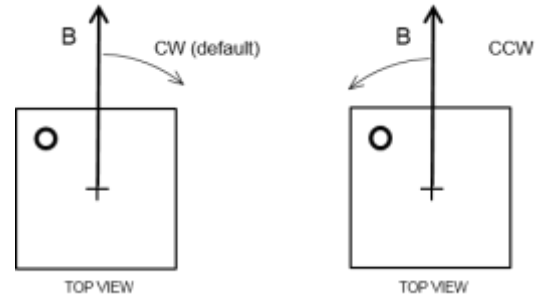

Figure 15: Positive Rotation Direction of the Magnetic Field

Table 10: Rotation Direction Parameter

RD	Positive Direction
0	Clockwise (CW)
1	Counterclockwise (CCW)

BCT Settings (Bias Current Trimming)

Side-Shaft

When the MA102 is mounted on the side of the magnet, the relation between the field angle and the mechanical angle is no longer directly linear. This effect is related to the fact that the tangential magnetic field is usually smaller than the radial field. We define the field ratio k with Equation (5):

$$k = B_{rad} / B_{tan} \quad (3)$$

Where B_{rad} is the maximum radial magnetic field, and B_{tan} is the maximum tangential magnetic field (see Figure 16).

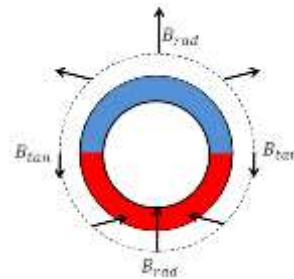

Figure 16: Side-Shaft Field

The ratio k depends on the magnet geometry and distance to the sensor. Having a k ratio different than 1 results in the sensor output response not being linear with respect to the mechanical angle. Note that the error curve has the shape of a double sinewave (see Figure 18). E is the amplitude of this error.

The X-axis or the Y-axis bias current can be reduced in order to recover an equal Hall signal for all angles and suppress the error. The parameter ETX and ETY controls the direction the sensitivity is reduced. The current reduction is set by the parameter bias current trimming BCT(7:0), which is an integer from 0 to 255.

In side-shaft configuration (i.e.: the sensor center is located beyond the magnet outer diameter), k is greater than 1. For optimum compensation, the sensitivity of the radial axis should be reduced by setting the BCT parameter as shown in Equation (6):

$$BCT(7:0) = 258 \left(1 - \frac{1}{k} \right) \quad (6)$$

Equation (6) is plotted in Figure 17 and Table 11.

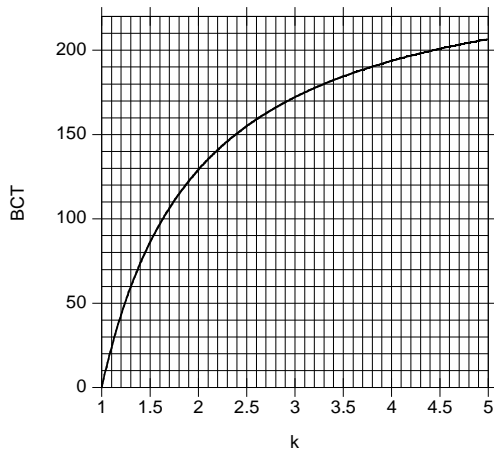

Figure 17: Relation between the k Ratio and the Optimum BCT to Recover Linearity

Table 11: Example of BCT Settings

E (deg)	Magnet Ratio k	BCT(7:0)
0	1.0	0
11.5	1.5	86
19.5	2.0	129
25.4	2.5	155
30.0	3.0	172
33.7	3.5	184
36.9	4.0	194
39.5	4.5	201
41.8	5.0	207

Determining k with the MagAlpha

It is possible to deduce the k ratio from the error curve obtained with the default BCT setting (BCT = 0). For this purpose, rotate the magnet over one revolution and record the MagAlpha output. Then plot the error curve (the MagAlpha output minus the real mechanical position vs. the real mechanical position) and extract two parameters: the maximum error E and the position of this maximum with respect to a zero crossing a_m (see Figure 18). k can be calculated with Equation (7):

$$k = \frac{\tan(E + a_m)}{\tan(a_m)} \quad (7)$$

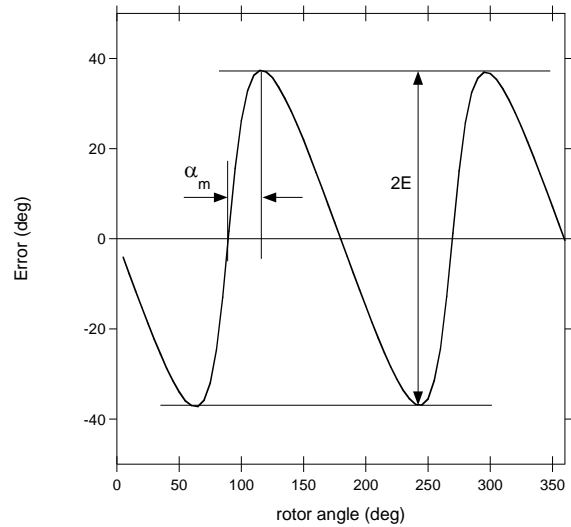

Figure 18: Error Curve in Side-Shaft Configuration with BCT = 0

Some examples are given in Table 11. Alternatively, the k parameter can be obtained from the graph in Figure 19.

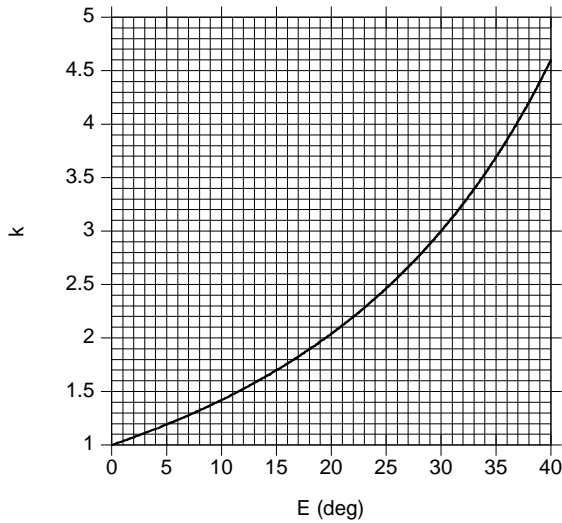

Figure 19: Relation between the Error Measured with BCT = 0 and the Magnet Ratio k

Sensor Orientation

The dot marked on the package shows whether the radial field is aligned with the sensor coordinate X or Y (see Figure 20).

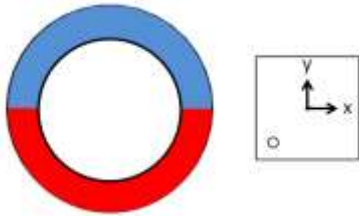

Figure 20: Package Top View with X and Y Axes

Determine which axis needs to be reduced (see the qualitative field distribution around a ring in Figure 16). For instance, with the arrangement depicted in Figure 20, the field along the sensor Y direction is tangential and weaker. Therefore, the X-axis should be reduced (ETX = 1 and ETY = 0). Note that if both ETX and ETY are set to 1, the current bias is reduced in both directions the same way (i.e.: without side-shaft correction).

Table 12: Trimming Direction Parameters

ETX	Enable Trimming of the X-Axis
0	Disabled
1	Enabled
ETY	Enable Trimming of the Y-Axis
0	Disabled
1	Enabled

Magnetic Field Thresholds

The magnetic flags (MGL and MGH) indicate that the magnetic field at the sensor position is out of range, defined by the lower and upper magnetic field thresholds, respectively MGLT and MGHT (see Figure 21).

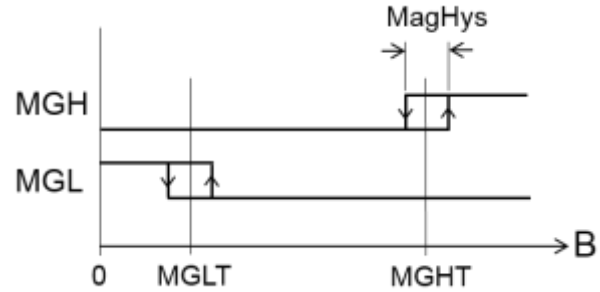

Figure 21: MGH and MGL Signals as a Function of the Field Strength

MagHys, the typical hysteresis on the signals MGH and MGL, is 6mT (see Figure 21). The MGLT and MGHT thresholds are coded on three bits and are stored in register 6 (see Table 13).

Table 13: Register 6

Register 6							
Bit 7	Bit 6	Bit 5	Bit 4	Bit 3	Bit 2	Bit 1	Bit 0
MGLT			MGHT			-	-

The 3-bit values of MGLT and MGHT correspond to the magnetic field (see Table 14).

Table 14: MGLT and MGHT Binary to mT Relation

MGLT or MGHT ⁽⁸⁾	Field threshold in mT ⁽⁷⁾	
	From low to high magnetic field	From high to low magnetic field
000	26	20
001	41	35
010	56	50
011	70	64
100	84	78
101	98	92
110	112	106
111	126	120

NOTES:

- 7) Valid for VDD = 3.3V. If different, then the field threshold is scaled by the factor VDD/3.3V.
- 8) MGLT can have a larger value than MGHT.

The alarm flags MGL and MGH can be read in register 27 (bit 6, bit 7), and their logic state is also given at the digital output pins 11 and 16.

To read the MGL and MGH flags by SPI, send the 8-bit command write into register 27:

command	reg. address	MSB	value	LSB
0 1 0	1 1 0 1 1	0	0 0 0 0 0 0 0 0	0

The MA102 answers with the register 27 content in the next transmission:

R[7:0]						
MGH	MGL	x	x	x	x	x

Block Commutation – UVW

The UVW output emulates the three Hall switches usually used for the block commutation of a three-phase electric motor. The three logic signals have a duty cycle of 50% and are shifted by 60 degrees relative to each other (see Figure 22).

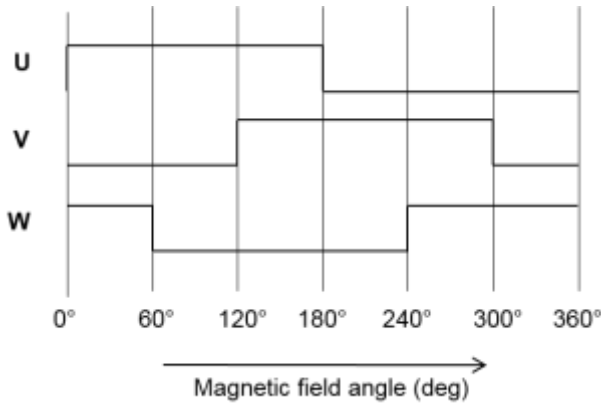

Figure 22: UVW Output for One Pole Pair Rotor during Rotation

If the number of pole pairs of the motor exceeds the number of pole pairs of the target magnet, the MA102 is able to generate more than one UVW cycle per revolution. It does this by dividing the digital angle into the required number of commutation steps per 360° revolution. The parameter NPP(2:0) in register 0x7 sets the number of pole pairs emulated, and the corresponding commutation step angle for the UVW signals. Table 15 describes the pole pair configuration options.

Table 15: Number of UVW Pair Poles

NPP (2:0)	Pole Pairs	States per Revolution	State Width (deg)
000	1	6	60
001	2	12	30
010	3	18	20
011	4	24	15
100	5	30	12
101	6	36	10
110	7	42	8.6
111	8	48	7.5

An example of the 30° UVW commutation signal spacing for a 4-pole (2-pole pair) motor is shown in Figure 23.

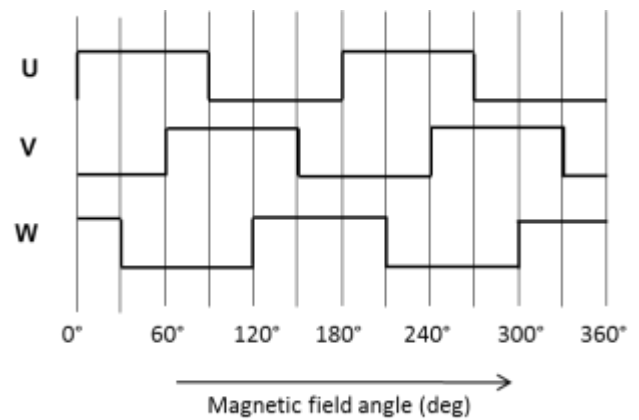

Figure 23: UVW Commutation Signals for a 4-Pole (2-Pole Pairs) Motor

UVW Hysteresis

A hysteresis larger than the output noise is introduced on the UVW output to avoid any spurious transitions (see Figure 24).

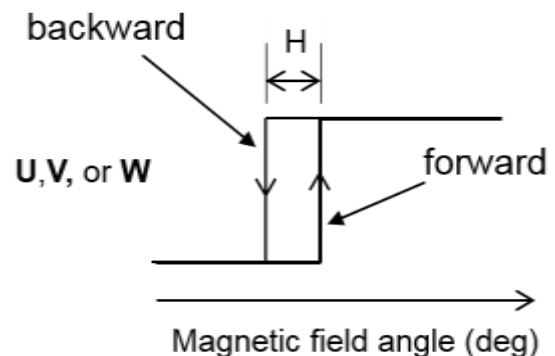

Figure 24: Hysteresis of the UVW Signal

TYPICAL APPLICATION CIRCUIT

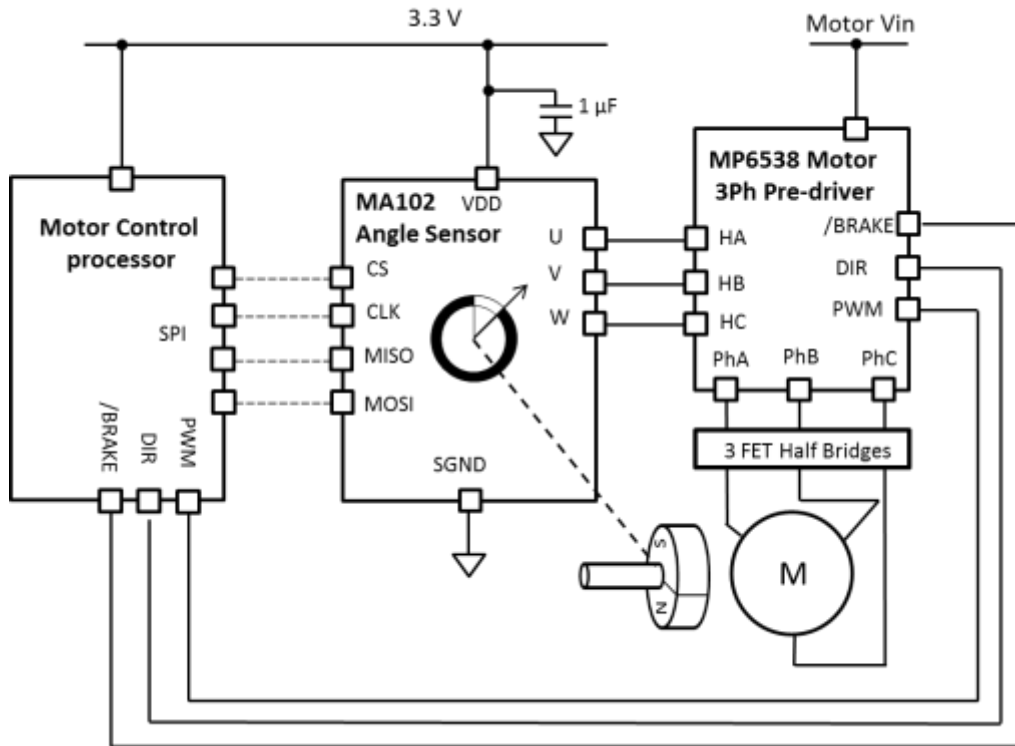
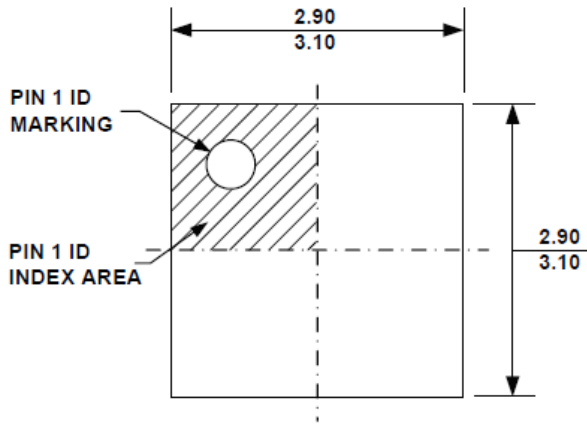

Figure 24: Typical Configuration Used with MP6538 3-Phase BLDC Pre-Driver

PACKAGE INFORMATION

QFN-16 (3mmx3mm)



TOP VIEW

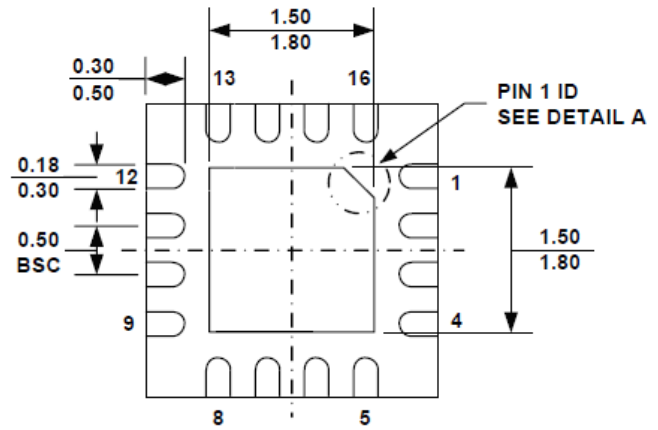

BOTTOM VIEW

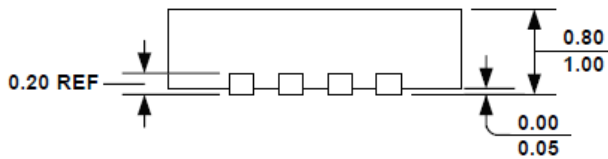

SIDE VIEW

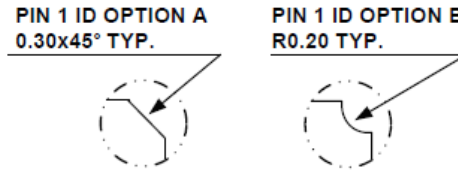

DETAIL A

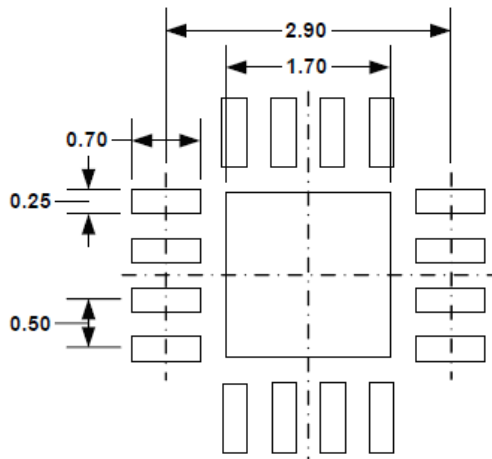

RECOMMENDED LAND PATTERN

NOTE:

- 1) ALL DIMENSIONS ARE IN MILLIMETERS.
- 2) EXPOSED PADDLE SIZE DOES NOT INCLUDE MOLD FLASH.
- 3) LEAD COPLANARITY SHALL BE 0.10 MILLIMETER MAX.
- 4) DRAWING CONFORMS TO JEDEC MO-220, VARIATION VEED-4.
- 5) DRAWING IS NOT TO SCALE.

APPENDIX A: DEFINITIONS

Effective Resolution (3σ noise level)	The smallest angle increment distinguishable from the noise. The resolution is measured by computing 3 times σ (the standard deviation in degrees) taken over 1,000 data points at a constant position. The resolution in bits is obtained with $\log_2(360/6\sigma)$.
Refresh Rate	Rate at which new data points are stored in the output buffer.
Latency	The time elapsed between the instant when the data is ready to be read and the instant at which the shaft passes that position. The lag in degrees is $lag = latency \cdot v$, where v is the angular velocity in deg/s.
Power-Up Time	Time until the sensor delivers valid data starting at power-up.
Integral Non-Linearity (INL)	Maximum deviation between the average sensor output (at a fixed position) and the true mechanical angle.

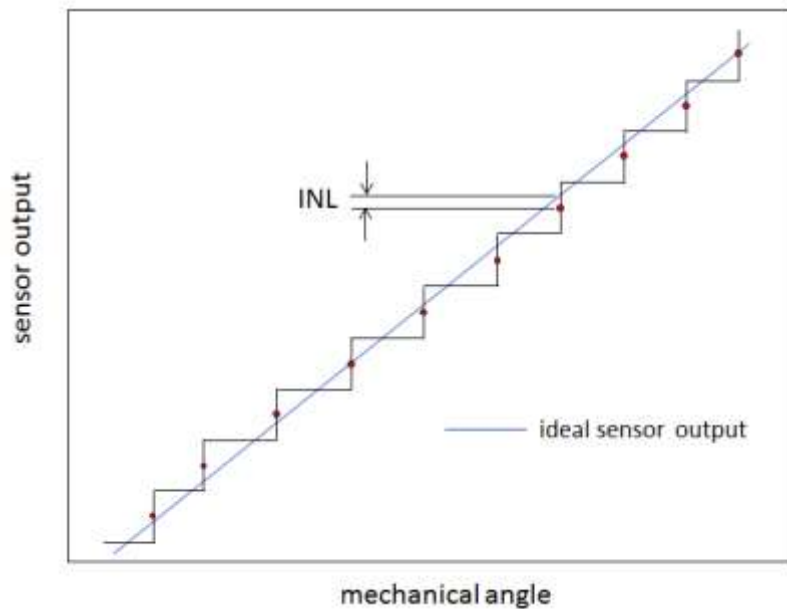
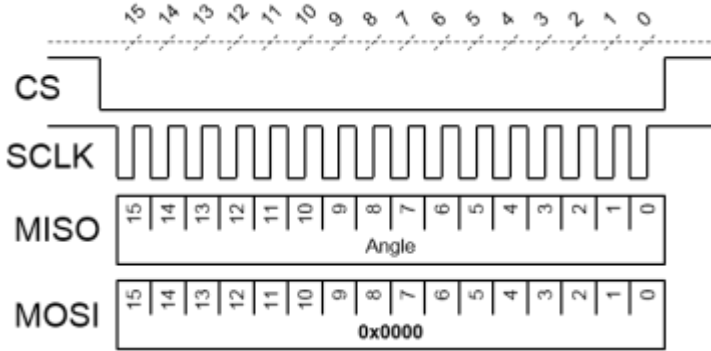

Figure A1: Integral Non-Linearity

Drift	Angle variation rate when one parameter is changed (e.g.: temperature, VDD) and all the others, including the shaft angle, are maintained constant.
--------------	---

APPENDIX B: SPI COMMUNICATION CHEATSHEET

Read Angle



Read Register

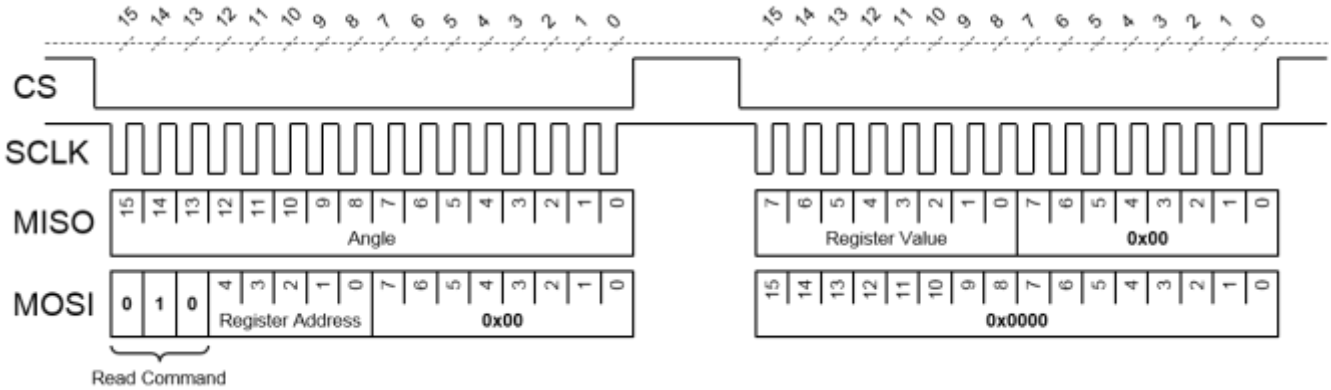

Write Register

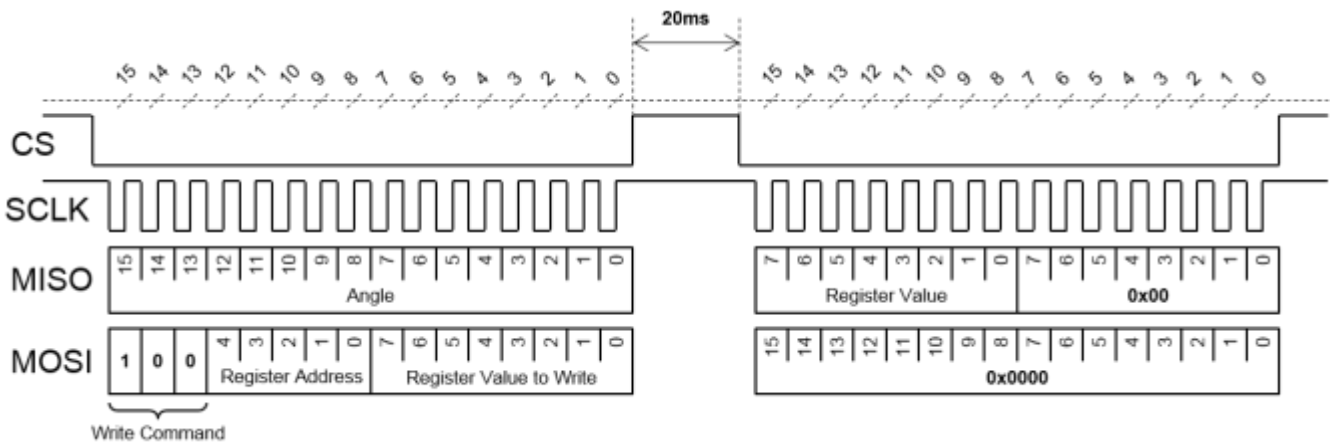

NOTICE: The information in this document is subject to change without notice. Users should warrant and guarantee that third party Intellectual Property rights are not infringed upon when integrating MPS products into any application. MPS will not assume any legal responsibility for any said applications.