



The Future of Analog IC Technology®

# MagAlpha MA704

## 10-Bit, Digital, Contactless Angle Sensor with ABZ Incremental & PWM Outputs

### DESCRIPTION

The MA704 detects the absolute angular position of a permanent magnet, typically a diametrically magnetized cylinder on a rotating shaft. The MA704 is particularly suited to track highly dynamic movements with speeds up to 60'000 rpm.

The MA704 supports a wide range of magnetic field strengths and spatial configurations. Both end-of-shaft and off-axis (side-shaft mounting) configurations are supported.

The MA704 features magnetic field strength detection with programmable thresholds to allow sensing of the magnet position relative to the sensor for creation of functions such as the sensing of axial movements or for diagnostics.

On-chip non-volatile memory provides storage for configuration parameters, including the reference zero angle position, ABZ encoder settings, and magnetic field detection thresholds.

### FEATURES

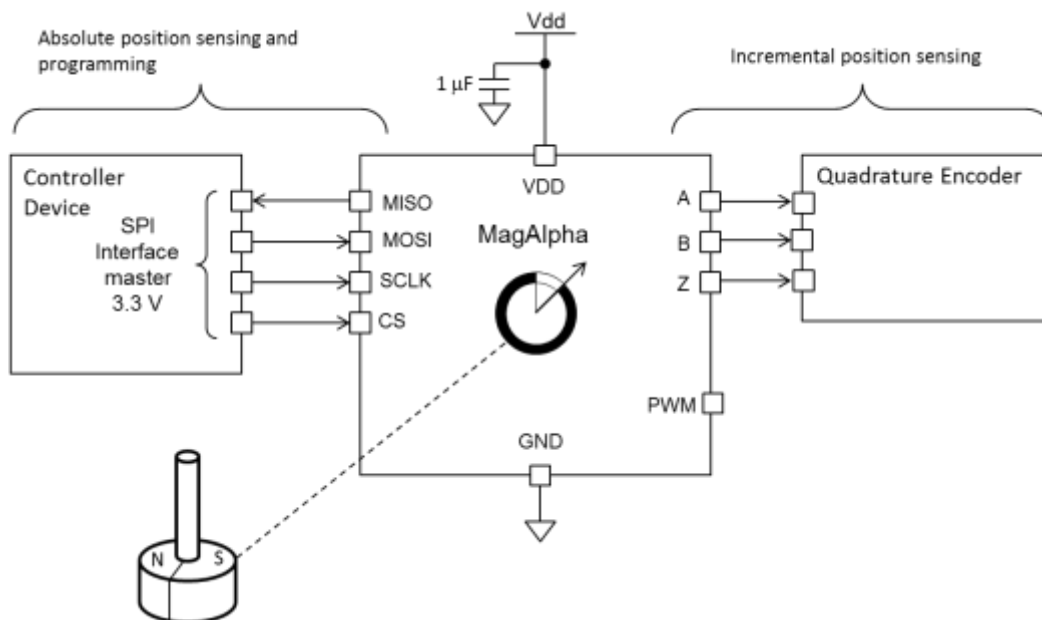
- 10-Bit Resolution Absolute Angle Encoder
- Contactless Sensing for Long Life
- SPI Serial Interface for Digital Angle Readout and Chip Configuration
- Incremental 8-Bit ABZ Quadrature Encoder Interface with Programmable Pulses Per Turn from 1-64
- PWM Output 10-Bit
- Programmable Magnetic Field Strength Detection for Diagnostic Checks
- 3.3V, 12 mA Supply
- -40°C to +125°C Operating Temperature
- Available in a QFN-16 (3mmx3mm) Package

### APPLICATIONS

- General Purpose Angle Measurement
- Angle Encoders
- Automotive Angle or Speed Sensors
- Robotics

All MPS parts are lead-free, halogen-free, and adhere to the RoHS directive. For MPS green status, please visit the MPS website under Quality Assurance. "MPS" and "The Future of Analog IC Technology" are registered trademarks of Monolithic Power Systems, Inc.

### TYPICAL APPLICATION



### ORDERING INFORMATION

Part Number*	Package	Top Marking
MA704GQ	QFN-16 (3mmx3mm)	See Below

\* For Tape & Reel, add suffix -Z (e.g. MA704GQ-Z)

### TOP MARKING

**BANY**

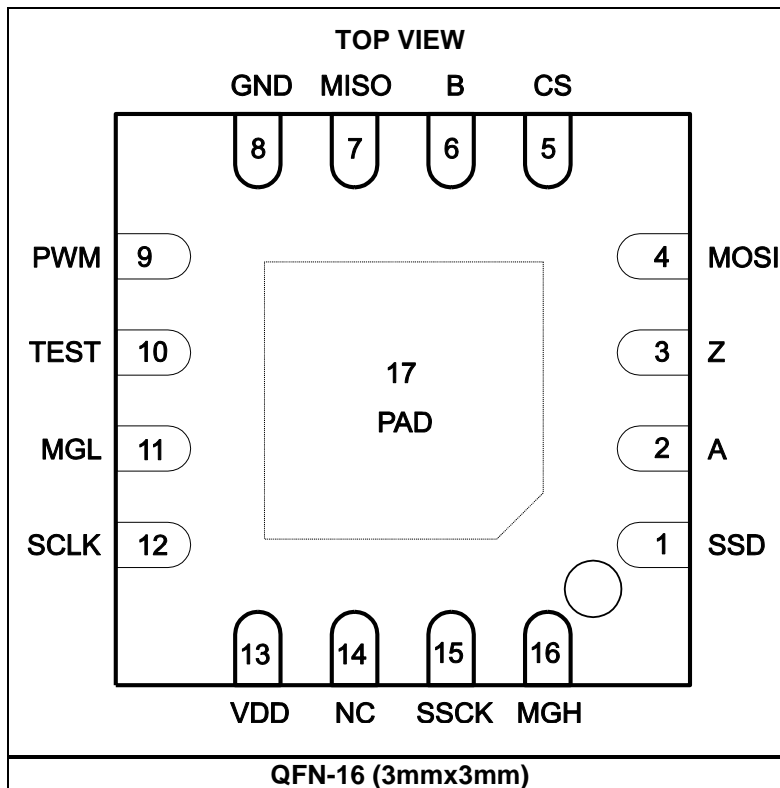
**LLL**

BAN: Product code of MA704GQ

Y: Year code

LLL: Lot number

### PACKAGE REFERENCE



**ABSOLUTE MAXIMUM RATINGS <sup>(1)</sup>**

Supply voltage .....	-0.5V to +4.6V
Input pin voltage (V <sub>I</sub> ) .....	-0.5V to +6.0V
Output pin voltage (V <sub>O</sub> ) .....	-0.5V to +4.6V
Continuous power dissipation (T <sub>A</sub> = +25°C) <sup>(2)</sup>	.....2.0W
Junction temperature .....	125°C
Lead temperature .....	260°C
Storage temperature .....	-65°C to 150°C

<b>Thermal Resistance <sup>(3)</sup></b>	<b><math>\theta_{JA}</math></b>	<b><math>\theta_{JC}</math></b>
QFN-16 (3mmx3mm) .....	50.....	12 ... °C/W

**NOTES:**

- 1) Exceeding these ratings may damage the device.
- 2) The maximum allowable power dissipation is a function of the maximum junction temperature T<sub>J</sub> (MAX), the junction-to-ambient thermal resistance  $\theta_{JA}$ , and the ambient temperature T<sub>A</sub>. The maximum allowable continuous power dissipation at any ambient temperature is calculated by  $P_D (MAX) = (T_J (MAX) - T_A) / \theta_{JA}$ .
- 3) Measured on JESD51-7, 4-layer PCB.

**ELECTRICAL CHARACTERISTICS**

Parameter	Symbol	Condition	Min	Typ	Max	Units
<b>Recommended Operating Conditions</b>						
Supply voltage	VDD		3.0	3.3	3.6	V
Supply current	IDD	From -40°C to +125°C	10.2	11.7	13.8	mA
Operating temperature	Top		-40		125	°C
Applied magnetic field	B		30	60		mT

**GENERAL CHARACTERISTICS**
**VDD = 3.3V, 45mT < B < 100mT, Temp = -40°C to +125°C, unless otherwise noted.**

Parameter	Symbol	Condition	Min	Typ	Max	Units
<b>Absolute Output – Serial</b>						
Effective resolution		3 $\sigma$ deviation of the noise distribution	9.5	10.0	10.5	bit
Noise RMS			0.04	0.06	0.08	deg
Refresh rate			850	980	1100	kHz
Data output length			12		12	bit
<b>Response Time</b>						
Power-up time <sup>(4)</sup>					1.1	ms
Latency <sup>(4)</sup>		Constant speed propagation delay	8		10	$\mu$ s
Filter cutoff frequency <sup>(4)</sup>	Fcutoff			2970		Hz
<b>Accuracy</b>						
INL at 25°C		At room temperature over the full field range		0.7		deg
INL between -40°C to +125°C <sup>(5)</sup>		Over the full temperature range and field range		1.1		deg
<b>Output Drift</b>						
Temperature induced drift at room temperature <sup>(5)</sup>				0.015	0.04	deg/°C
Temperature induced variation <sup>(5)</sup>		From 25°C to 85°C		0.5	1.2	deg
		From 25°C to 125°C		1.0	2.1	deg
Magnetic field induced <sup>(5)</sup>				0.005		deg/mT
Voltage supply induced <sup>(5)</sup>					0.3	deg/V
<b>Absolute Output – PWM</b>						
PWM frequency			782	920	1010	Hz
PWM resolution			9.5		10.0	bit
<b>Incremental Output – ABZ</b>						
ABZ update rate				16		MHz
Resolution - edges per turn		Programmable	4		256	
Pulses per channel per turn	PPT+1	Programmable	1		64	
ABZ hysteresis <sup>(5)</sup>	H				1.1	deg
Systematic jitter <sup>(5)</sup>		For PPT = 63, 0 - 100kRPM			6.0	%
Random jitter (3 $\sigma$ )		For PPT = 63, 0 - 100kRPM			3.0	%
Overall ABZ jitter <sup>(5)</sup>					0.5	deg

**GENERAL CHARACTERISTICS (continued)**
**VDD = 3.3V, 45mT < B < 100mT, Temp = -40°C to +125°C, unless otherwise noted.**

Parameter	Symbol	Condition	Min	Typ	Max	Units
<b>Magnetic Field Detection Thresholds</b>						
Accuracy <sup>(5)</sup>				5		mT
Hysteresis <sup>(5)</sup>	MagHys			6		mT
Temperature drift <sup>(5)</sup>				-600		ppm/°C
<b>Digital I/O</b>						
Input high voltage	V <sub>IH</sub>		2.5		5.5	V
Input low voltage	V <sub>IL</sub>		-0.3		0.8	V
Output low voltage <sup>(5)</sup>	V <sub>OL</sub>	I <sub>OL</sub> = 4mA			0.4	V
Output high voltage <sup>(5)</sup>	V <sub>OH</sub>	I <sub>OH</sub> = 4mA	2.4			V
Pull-down resistor	RPD		43	55	97	kΩ
Rising edge slew rate <sup>(4)</sup>	T <sub>R</sub>	CL = 50pF		0.7		V/ns
Falling edge slew rate <sup>(4)</sup>	T <sub>F</sub>	CL = 50pF		0.7		V/ns

**NOTES:**

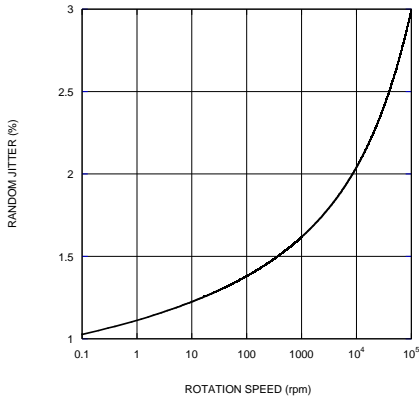
4) Guaranteed by design.

5) Guaranteed by characteristic test.

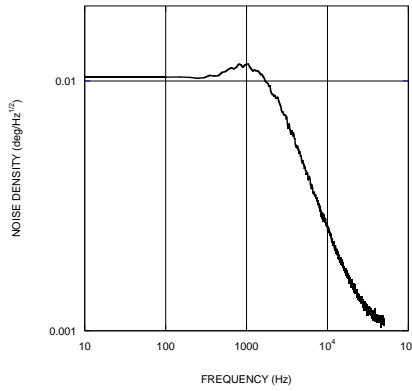
## TYPICAL CHARACTERISTICS

VDD = 3.3V, Temp = 25°C, unless otherwise noted.

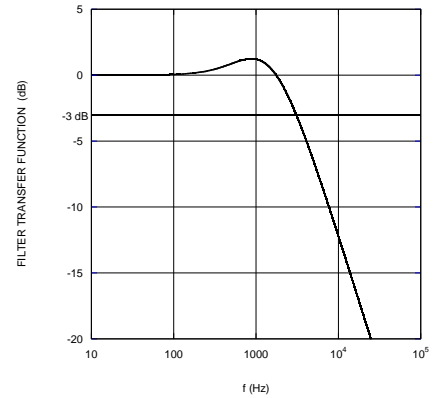
**ABZ Jitter at PPT = 255**



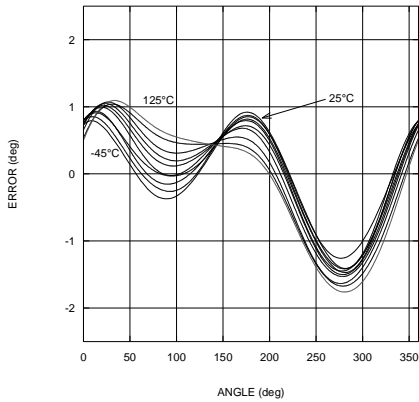
**Noise Spectrum at 50mT**



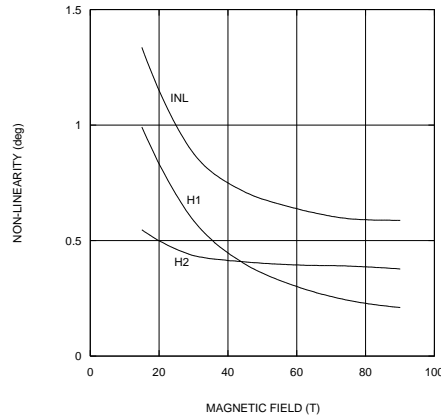
**Filter Transfer Function**



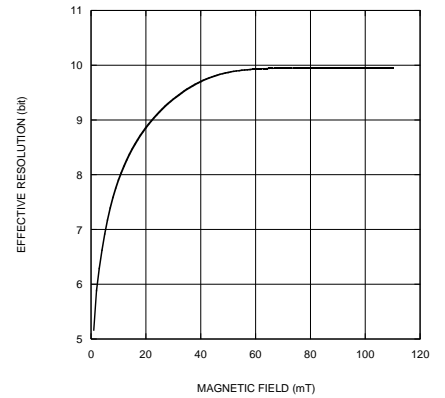
**Error Curves at 50mT**



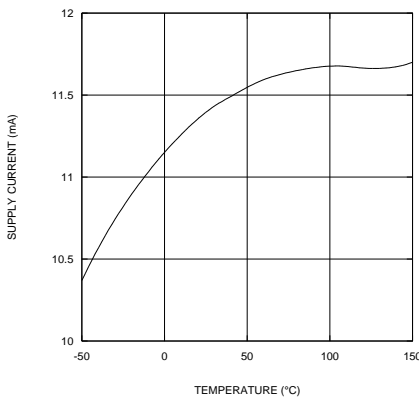
**Non-Linearity (INL and Harmonics)**



**Effective Resolution (3σ)**



**Current Consumption at VDD = 3.3V**

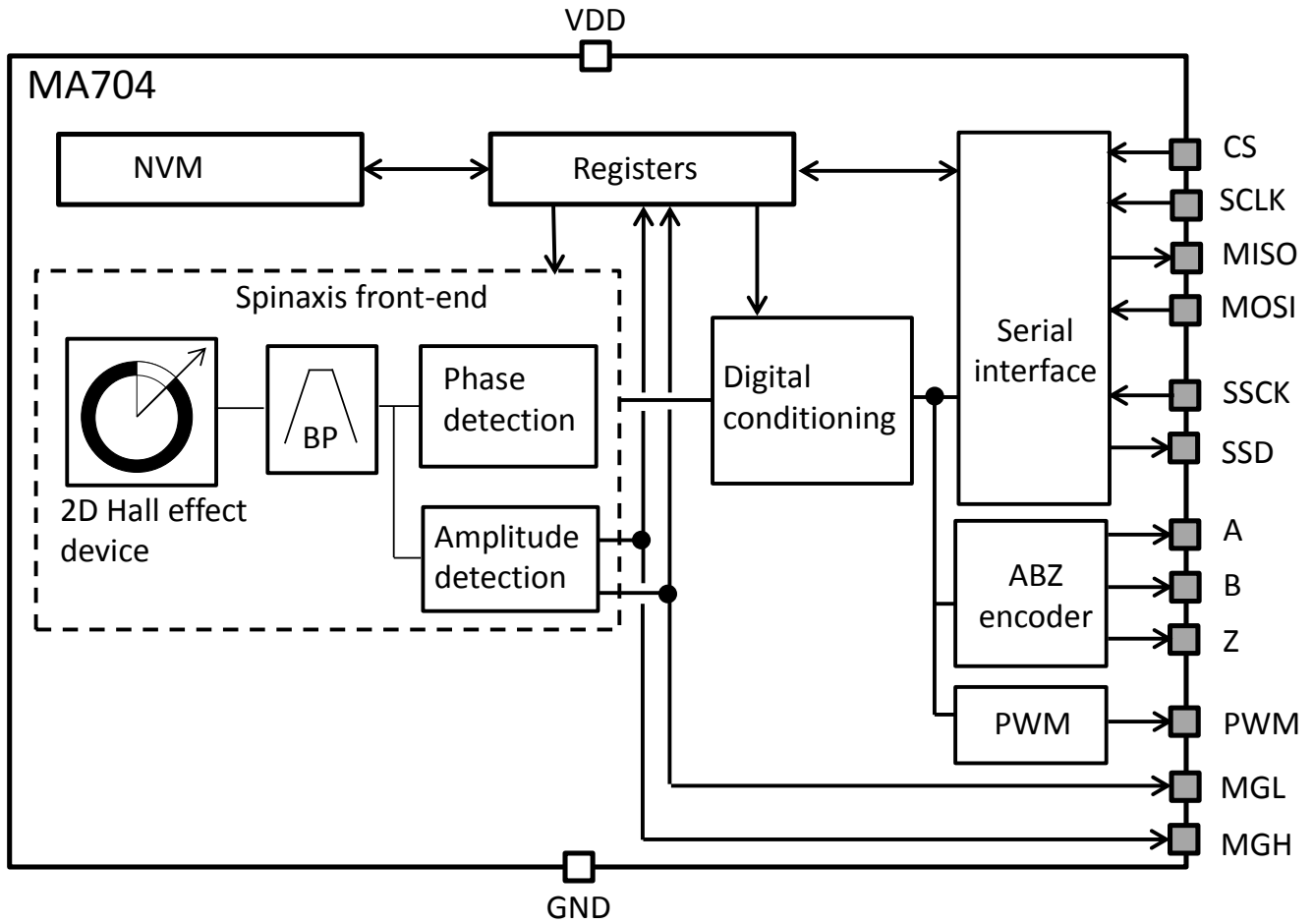


## PIN FUNCTIONS

Package Pin #	Name	Description
1	SSD	<b>Data out (SSI).</b>
2	A	<b>Incremental output.</b>
3	Z	<b>Incremental output.</b>
4	MOSI	<b>Data in (SPI).</b> MOSI has an internal pull-down resistor.
5	CS	<b>Chip select (SPI).</b> CS has an internal pull-up resistor.
6	B	<b>Incremental output.</b>
7	MISO	<b>Data out (SPI).</b> MISO has an internal pull-down resistor that is enabled at a high impedance state.
8	GND	<b>Supply ground.</b>
9	PWM	<b>PWM output.</b>
10	TEST	<b>Connect to ground.</b>
11	MGL	<b>Digital output indicating field strength below MGLT level.</b>
12	SCLK	<b>Clock (SPI).</b> SCLK has an internal pull-down resistor.
13	VDD	<b>Supply 3.3V.</b>
14	NC	<b>No connection.</b> Leave NC unconnected.
15	SSCK	<b>Clock (SSI).</b> SSCK has an internal pull-down resistor.
16	MGH	<b>Digital output indicating field strength above MGHT level.</b>



**BLOCK DIAGRAM**



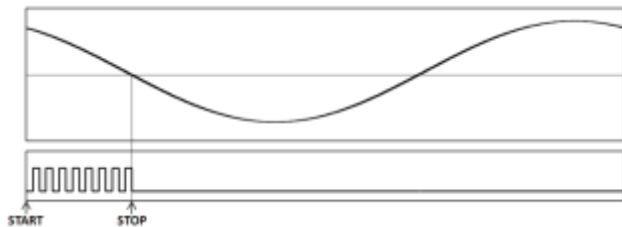
**Figure 1: Functional Block Diagram**

## OPERATION

### Sensor Front-End

The magnetic field is detected with integrated Hall devices located in the center of the package. The angle is measured using the *Spinaxis™* method, which digitizes the direction of the field directly without complex arctangent computation or feedback loop-based circuits (interpolators).

The *Spinaxis™* method is based on phase detection and generates a sinusoidal signal with a phase that represents the angle of the magnetic field. The angle is then obtained by a time-to-digital converter, which measures the time between the zero crossing of the sinusoidal signal and the edge of a constant waveform (see Figure 2). The time-to-digital is output from the front-end to the digital conditioning block.



**Top: Sine Waveform**  
**Bottom: Clock of Time-to-Digital Converter**  
**Figure 2: Phase Detection Method**

The output of the front-end delivers a digital number proportional to the angle of the magnetic field at the rate of 1MHz in a straightforward and open-loop manner.

### Digital Filtering

The front-end signal is further treated to achieve the final effective resolution. This treatment does not add any latency in steady conditions. The filter transfer function can be calculated with Equation (1):

$$H(s) = \frac{1 + 2\tau s}{(1 + \tau s)^2} \quad (1)$$

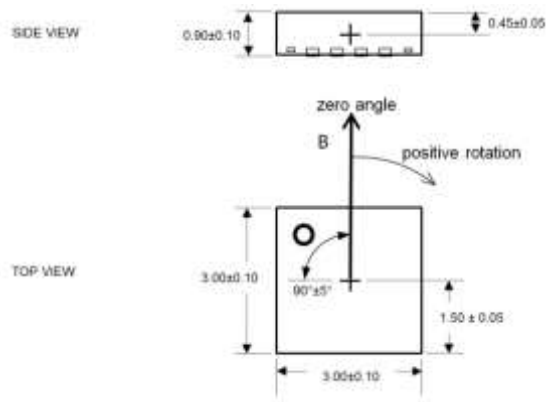
Where  $\tau$  is the filter time constant related to the cutoff frequency by:  $\tau = 0.38/F_{cutoff}$ . See the General Characteristics table on page 5 for the value of *F<sub>cutoff</sub>*.

### Sensor – Magnet Mounting

The sensitive volume of the MA704 is confined in a region less than 100µm wide and has

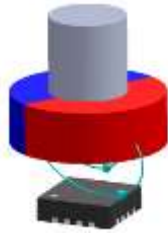
multiple integrated Hall devices. This volume is located both horizontally and vertically within 50µm of the center of the QFN package. The sensor detects the angle of the magnetic field projected in a plane parallel to the package's upper surface. This means that the only relevant magnetic field is the in-plane component (X and Y components) in the middle point of the package.

By default, when looking at the top of the package, the angle increases when the magnetic field rotates clockwise. Figure 3 shows the zero angle of the unprogrammed sensor, where the cross indicates the sensitive point. Both the rotation direction and the zero angle can be programmed.

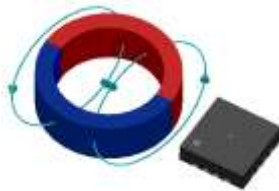


**Figure 3: Detection Point and Default Positive Direction**

This type of detection provides flexibility for the design of an angular encoder. The sensor only requires the magnetic vector to lie essentially within the sensor plane with a field amplitude of at least 30mT. Note that the MA704 can work with fields smaller than 30mT, but the linearity and resolution performance may deviate from the specifications. The most straightforward mounting method is to place the MA704 sensor on the rotation axis of a permanent magnet (i.e.: a diametrically magnetized cylinder) (see Figure 4). The recommended magnet is a Neodymium alloy (N35) cylinder with dimensions Ø5x3mm inserted into an aluminum shaft with a 1.5mm air gap between the magnet and the sensor (surface of package). For good linearity, the sensor is positioned with a precision of 0.5mm.

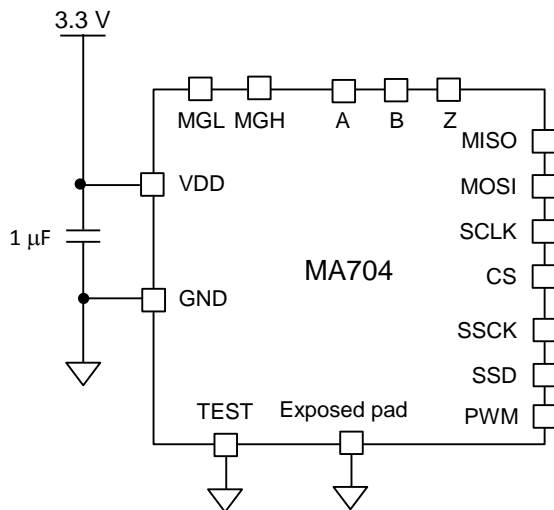

**Figure 4: End-of-Shaft Mounting**

If the end-of-shaft position is not available, the sensor can be positioned away from the rotation axis of a cylinder or ring magnet (see Figure 5). In this case, the magnetic field angle is no longer directly proportional to the mechanical angle. The MA704 can be adjusted to compensate for this effect and recover the linear relation between the mechanical angle and the sensor output. With multiple pole pair magnets, the MA704 indicates multiple rotations for each mechanical turn.


**Figure 5: Side-Shaft Mounting**

### Electrical Mounting and Power Supply Decoupling

It is recommended to place a 1 $\mu$ F decoupling capacitor close to the sensor with a low impedance path to GND (see Figure 6).


**Figure 6: Connection for Supply Decoupling**

In general, the MagAlpha works well with or without the exposed pad connected to anything. For optimum conditions (electrically, thermally, and mechanically), it is recommended that the exposed pad be connected to ground.

### Serial Interface

The sensor supports the SPI serial interface for angle reading and register programming. Alternatively, the SSI bus can be used for angle reading (programming through SSI is not supported).

#### SPI

SPI is a four-wire, synchronous, serial communication interface. The MagAlpha supports SPI Mode 3 and Mode 0 (see Table 1 and Table 2). The SPI Mode (0 or 3) is detected automatically by the sensor and therefore does not require any action from the user. The maximum clock rate supported on SPI is 25MHz. There is no minimum clock rate. Note that real-life data rates depend on the PCB layout quality and signal trace length. See Figure 7 and Table 3 for SPI timing.

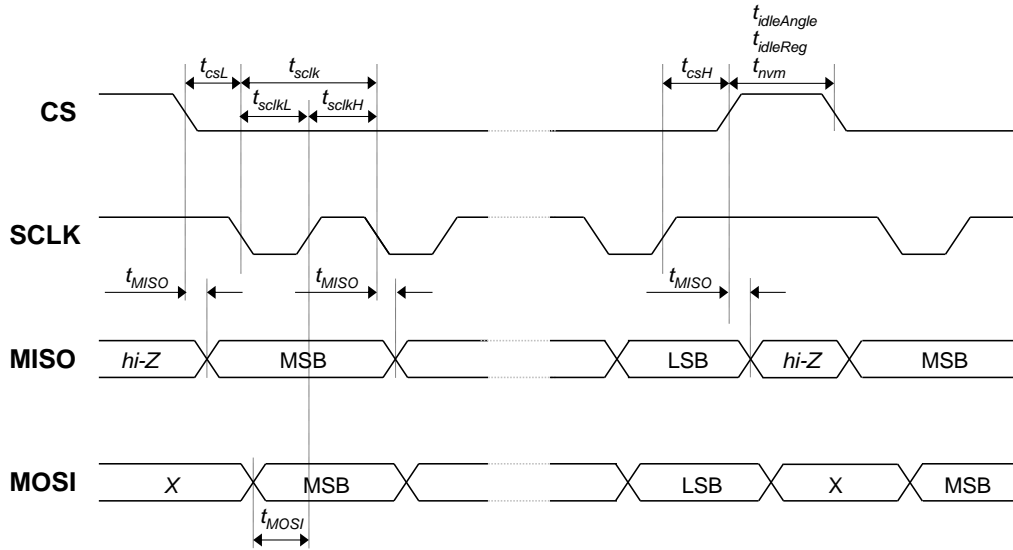
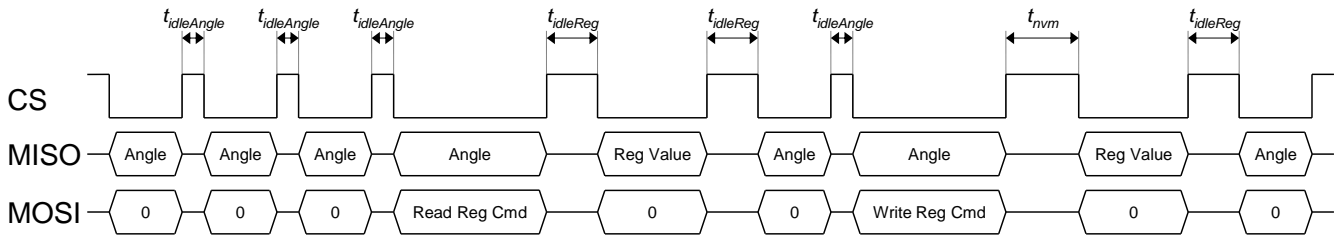
All commands to the MagAlpha (whether for writing or reading register content) must be transferred through the SPI MOSI pin and must be 16-bit long. See the SPI Communication section on page 13 for details.

**Table 1: SPI Specification**

	Mode 0	Mode 3
SCLK idle state	Low	High
Data capture	On SCLK rising edge	
Data transmission	On SCLK falling edge	
CS idle state	High	
Data order	MSB first	

**Table 2: SPI Standard**

	Mode 0	Mode 3
CPOL	0	1
CPHA	0	1
Data Order (DORD)	0 (MSB first)	


**Figure 7: SPI Timing Diagram**

**Figure 8: Minimum Idle Time**
**Table 3: SPI Timing**

Parameter <sup>(6)</sup>	Description	Min	Max	Unit
$t_{idleAngle}$	Idle time between two subsequent angle transmissions	150		ns
$t_{idleReg}$	Idle time before and after a register readout	750		ns
$t_{nvm}$	Idle time between a write command and a register readout (delay necessary for non-volatile memory update)	20		ms
$t_{csL}$	Time between CS falling edge and SCLK falling edge	80		ns
$t_{sclk}$	SCLK period	40		ns
$t_{sclkL}$	Low level of SCLK signal	20		ns
$t_{sclkH}$	High level of SCLK signal	20		ns
$t_{csH}$	Time between SCLK rising edge and CS rising edge	25		ns
$t_{MISO}$	SCLK setting edge to data output valid		15	ns
$t_{MOSI}$	Data input valid to SCLK reading edge	15		ns

**NOTE:**

6) All values are guaranteed by design.

### SPI Communication

The sensor supports three types of SPI operation:

- Read angle
- Read configuration register
- Write configuration register

Each operation has a specific frame structure described below.

#### SPI Read Angle

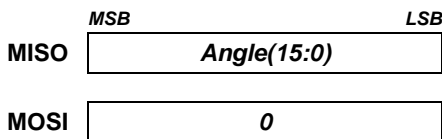
Every 1µs, new data is transferred into the output buffer. The master device triggers the reading by pulling CS low.

When a trigger event is detected, the data remains in the output buffer until the CS signal is de-asserted (see Table 4).

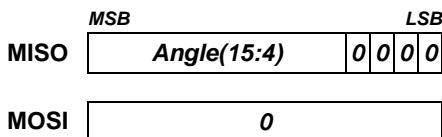
**Table 4: Sensor Data Timing**

Event	Action
CS falling edge	Start reading and freeze output buffer
CS rising edge	Release of the output buffer

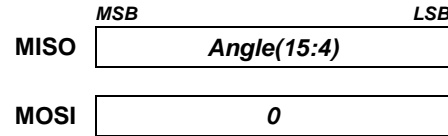
See Figure 9 for a diagram of a full SPI angle reading. See Figure 10 for a partial SPI angle reading. A full angle reading requires 16 clock pulses. The sensor MISO line returns:



The MagAlpha family has sensors with different features and levels of resolution. See the data output length section in the General Characteristics table on page 5 for the number of useful bits delivered at the serial output. If the data length is smaller than 16, the rest of the bits sent are zeros. For example, a data output length of 12 bits means that the serial output delivers a 12-bit angle value with four bits of zeros padded at the end (MISO state remains zero). If the master sends 16 clock counts, the MagAlpha replies with:

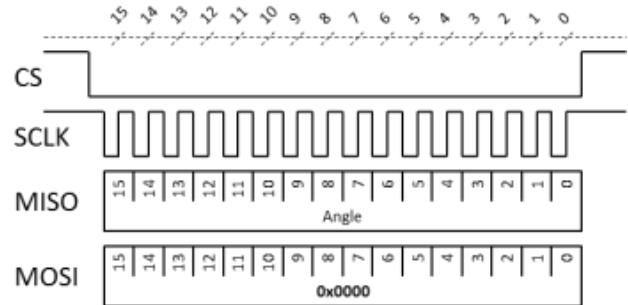


Angle reading can be therefore optimized, without any loss of information, by reducing the number of clock counts. In the case of a 12-bit data output length, only 12 clock counts are required to get the full sensor resolution.

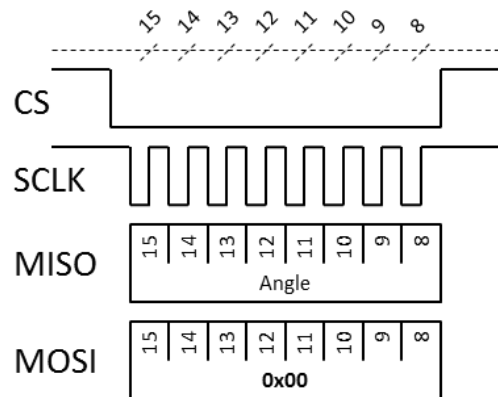


If less resolution is needed, the angle can be read by sending even fewer clock counts (since the MSB is first).

In case of fast reading, the MagAlpha continues sending the same data until the data is refreshed. See the refresh rate section in the General Characteristics table on page 5.



**Figure 9: Diagram of a Full 16-Bit SPI Angle Reading**

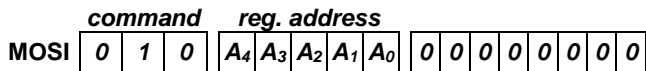
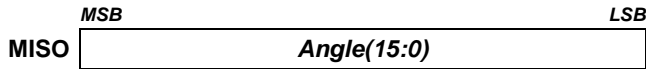


**Figure 10: Diagram of a Partial 8-Bit SPI Angle Reading**

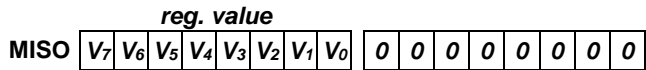
**SPI Read Register**

A read register operation is constituted of two 16-bit frames. The first frame sends a read request, which contains the 3-bit read command (010) followed by the 5-bit register address. The last eight bits of the frame must be all set to zero. The second frame returns the 8-bit register value (MSB byte).

First 16-bit SPI frame (read request):

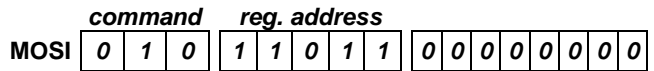
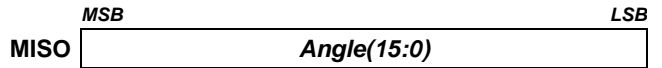


Second 16-bit SPI frame (response):

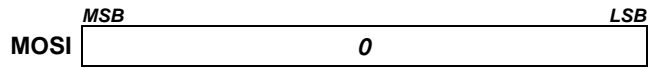
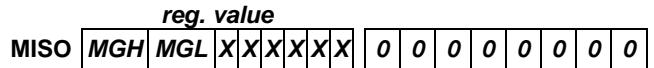


See Figure 11 for a complete transmission overview.

For example, to get the value of the magnetic level high and low flags (MGH and MGL), read register 27 (bit 6, bit 7) by sending the following first frame:



In the second frame, the MagAlpha replies:



See Figure 12 for a complete example overview.

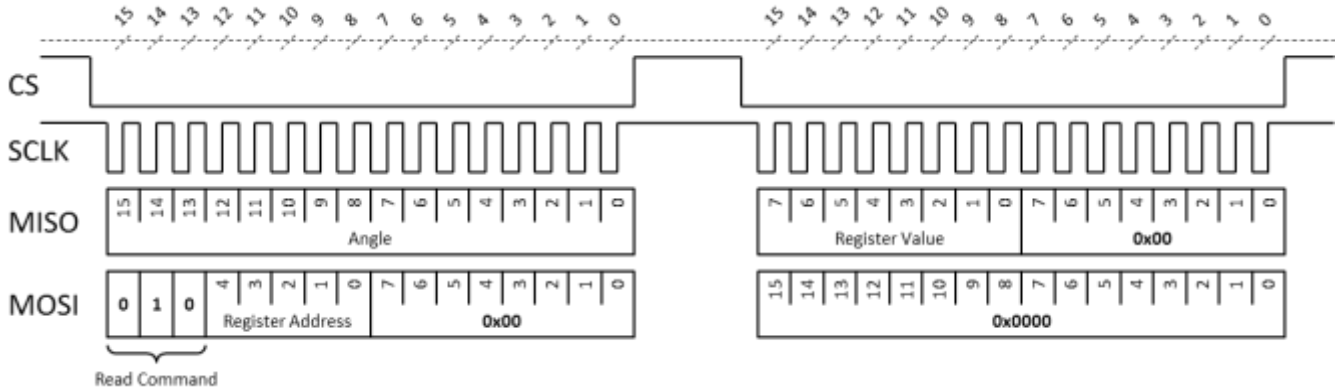


Figure 11: Two 16-Bit Frames Read Register Operation

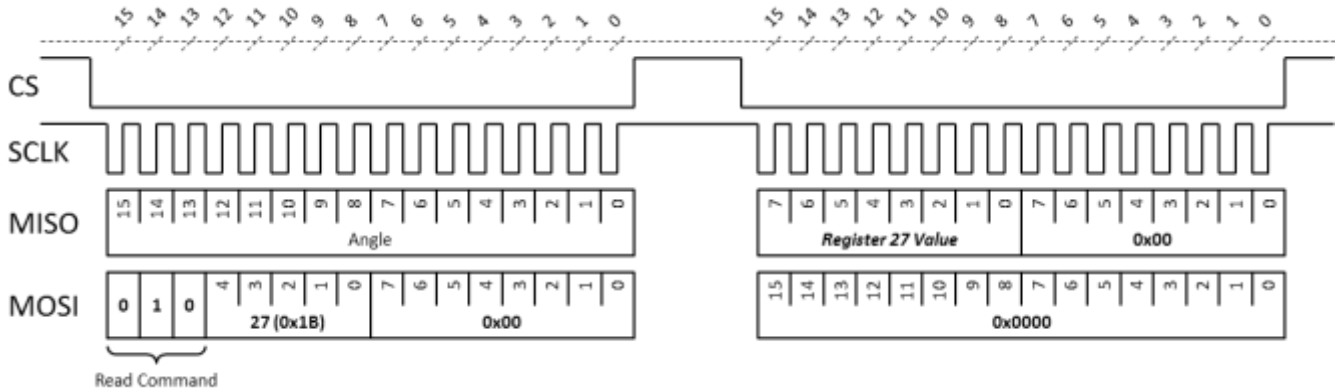


Figure 12: Example Read Magnetic Level Flags High and Low (MGH, MGL) on Register 27, Bit 7-6

**SPI Write Register**

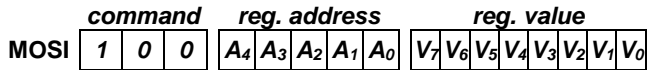
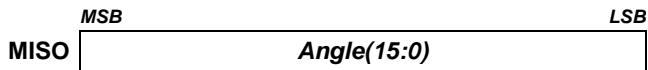
Table 7 shows the programmable 8-bit registers. Data written to these registers are stored in the on-chip non-volatile memory and reloaded at power-on automatically. The factory default register values are shown in Table 8.

A write register operation is constituted of two 16-bit frames. The first frame sends a write request, which contains the 3-bit write command (100) followed by the 5-bit register address and the 8-bit value (MSB first). The second frame returns the newly written register value (acknowledge).

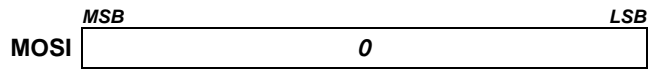
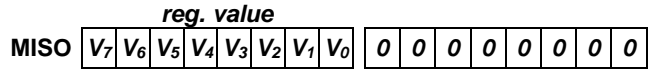
The on-chip memory is guaranteed to endure 1,000 write cycles at 25°C.

It is critical to wait 20ms between the first and the second frame. This is the time taken to write the non-volatile memory. Failure to implement this wait period results in the register's previous value being read. Note that this delay is only required after a write request. A read register request and read angle do not require this wait time.

First 16-bit SPI frame (write request):

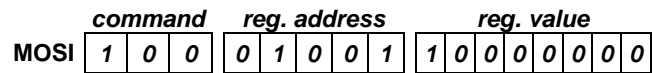
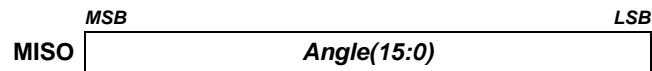


Second 16-bit SPI frame (response):

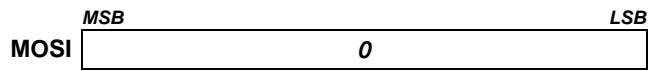
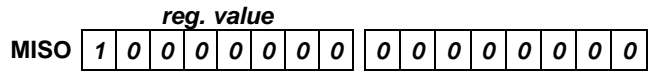


The read back register content can be used to verify the register programming. See Figure 13 for a complete transmission overview.

For example, to set the value of the output rotation direction (RD) to counterclockwise (high). Write register 9 by sending the following first frame:



Send the second frame after a 20ms wait time. If the register is written correctly, the reply is:



See Figure 14 for a complete example.

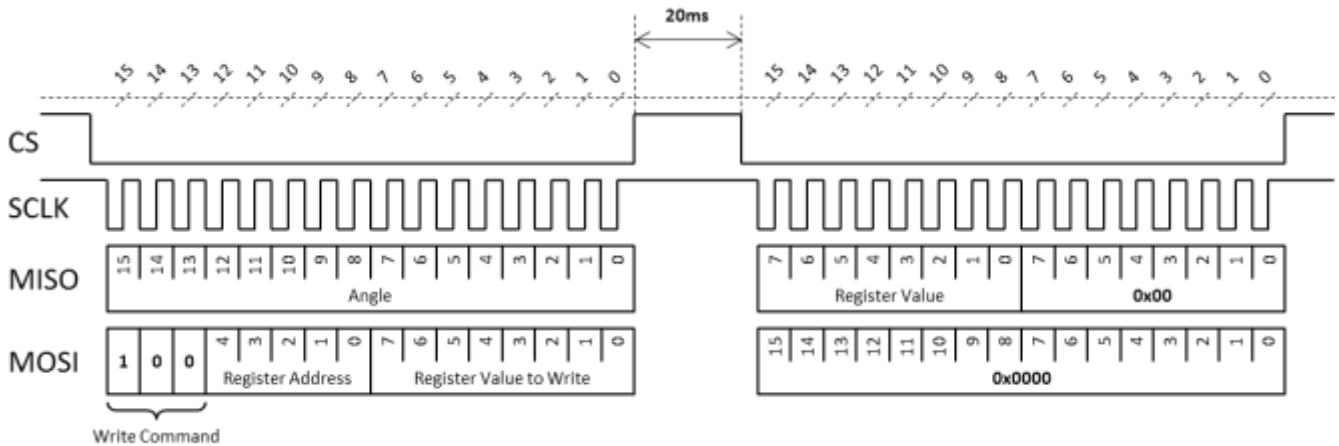


Figure 13: Overview of Two 16-Bit Frames Write Register Operation



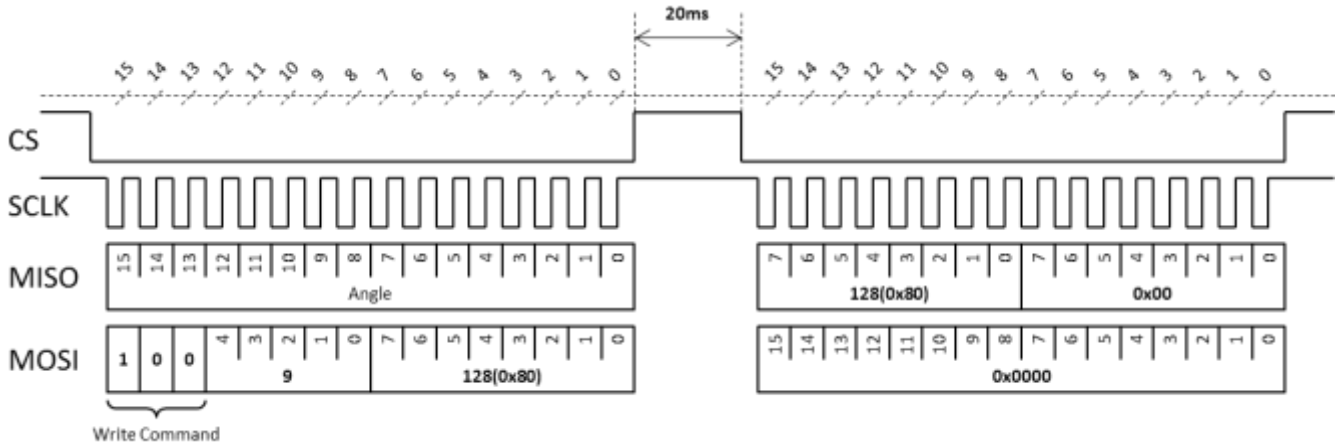


Figure 14: Example Write Output Rotation Direction (RD) to Counterclockwise (High), on Register 9, Bit 7

**SSI**

SSI is a two-wire synchronous serial interface for data reading only. The sensor operates as a slave to the external SSI master and supports only angle reading. It is not possible to read or write registers by SSI.

**SSI Communication**

Unlike SPI, the sensor SSI only supports angle reading operation. It is not possible to read or write registers using SSI. SSI timing communication is shown in Figure 15 and Table 5.

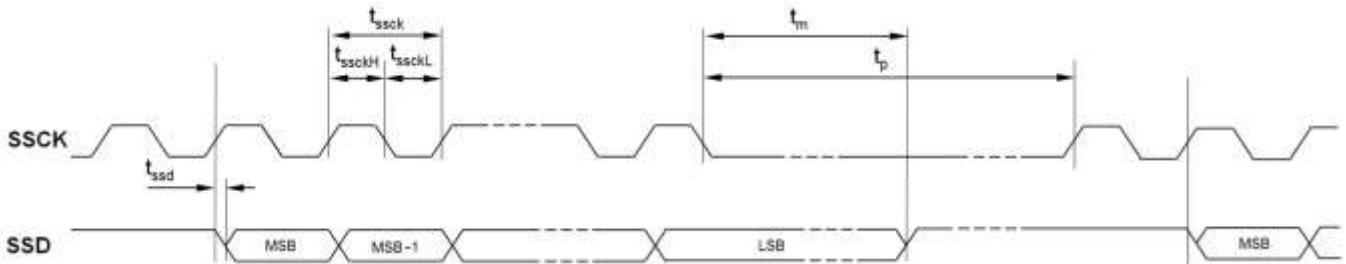


Figure 15: SSI Timing

Table 5: SSI Timing

Parameter	Description	Min	Max	Unit
$t_{ssd}$			15	ns
$t_{ssck}$	SSCK period	0.04	16	$\mu$ s
$t_{ssckL}$	Low level of SSCK signal	0.02	8	$\mu$ s
$t_{ssckH}$	High level of SSCK signal	0.02	8	$\mu$ s
$t_m$	Transfer timeout (monoflop time)	25		$\mu$ s
$t_p$	Dead time: SSCK high time for next data reading	40		$\mu$ s

**SSI Read Angle**

The bit order of the transmitted data is MSB first and LSB last. Every 1 $\mu$ s, new data is transferred into the output buffer. The master device triggers the reading by driving SCLK high. A full reading requires up to 17 clock counts (see Figure 16).

The first clock is a dummy clock to start the transmission. The data length is up to 16 bits long. See the data output length section in the General Characteristics table on page 5 for the number of useful bits delivered at the serial output.

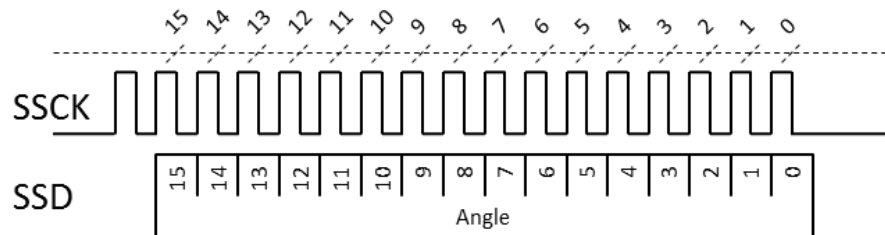


The first data MSB is transmitted on the second clock count. If the data length is less than 16, the 16-bit output word is completed by zeros. Therefore, the reading can also be performed with fewer than 16 clock counts. For example, for a part with a 12-bit data length, it is only necessary to send the first dummy clock to start the transmission + 12 clocks to read the angle data.

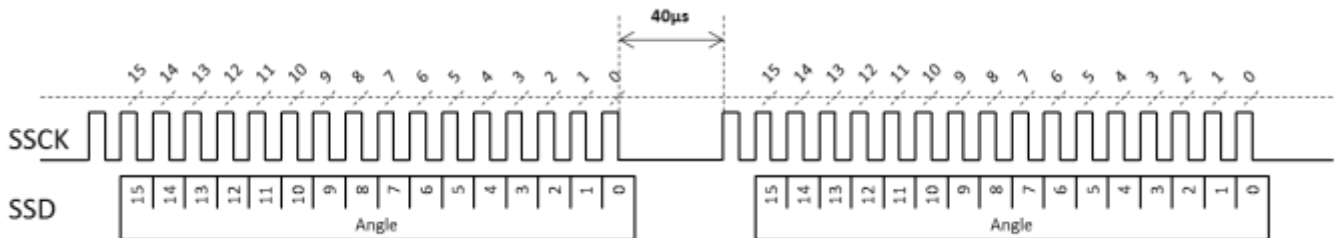
When a trigger event is detected, the data remains in the output buffer until the clock falling edge for the LSB bit 0 and the transfer timeout time has passed (see Table 6).

**Table 6: Sensor Data Timing**

Trigger Event	Release of the Output Buffer
First SSCK pulse rising edge	SSCK falling edge + time out $t_m$ (Fig 15)


**Figure 16: Diagram of a Full 16-Bit SSI Angle Reading (with First Dummy Clock)**

For consecutive angle readings, see the timing in Figure 17.


**Figure 17: Diagram of Two Consecutive 16-Bit SSI Angle Reading with the Required Dead Time between the Frames**

**REGISTER MAP**
**Table 7: Register Map**

No	Hex	Bin	Bit 7 MSB	Bit 6	Bit 5	Bit 4	Bit 3	Bit 2	Bit 1	Bit 0 LSB
0	0x0	00000	Z(7:0)							
1	0x1	00001	Z(15:8)							
2	0x2	00010	BCT(7:0)							
3	0x3	00011	-	-	-	-	-	-	ETY	ETX
4	0x4	00100	PPT(1:0)			ILIP(3:0)			-	-
5	0x5	00101	-	-	-	-	PPT(5:2)			
6	0x6	00110	MGLT(2:0)			MGHT(2:0)			-	-
9	0x9	01001	RD	-	-	-	-	-	-	-
27	0x1B	11011	MGH	MGL	-	-	-	-	-	-

**Table 8: Factory Default Values**

No	Hex	Bin	Bit 7 MSB	Bit 6	Bit 5	Bit 4	Bit 3	Bit 2	Bit 1	Bit 0 LSB
0	0x0	00000	0	0	0	0	0	0	0	0
1	0x1	00001	0	0	0	0	0	0	0	0
2	0x2	00010	0	0	0	0	0	0	0	0
3	0x3	00011	0	0	0	0	0	0	0	0
4	0x4	00100	1	1	0	0	0	0	0	0
5	0x5	00101	0	0	0	0	1	1	1	1
6	0x6	00110	0	0	0	1	1	1	0	0
9	0x9	01001	0	0	0	0	0	0	0	0

**Table 9: Programming Parameters**

Parameters	Symbol	Number of Bits	Description	See Table
Zero Setting	Z	16	Set the zero position	10
Bias Current Trimming	BCT	8	For side-shaft configuration: reduce the bias current of the X or Y Hall device	13
Enable Trimming X	ETX	1	Biased current trimmed in the X direction Hall device	14
Enable Trimming Y	ETY	1	Biased current trimmed in the Y direction Hall device	14
Pulses Per Turn	PPT	6	Number of pulses per turn of the ABZ output	17
Index Length / Index Position	ILIP	4	Parametrization of the ABZ index pulse	Fig 26
Magnetic Field High Threshold	MGHT	3	Sets the field strength high threshold	16
Magnetic Field Low Threshold	MGLT	3	Sets the field strength low threshold	16
Rotation Direction	RD	1	Determines the sensor positive direction	12

## REGISTER SETTINGS

### Zero Setting

The zero position of the MagAlpha ( $a_0$ ) can be programmed with 16 bits of resolution. The angle streamed out by the MagAlpha ( $a_{out}$ ) is given by Equation (2):

$$a_{out} = a_{raw} - a_0 \quad (2)$$

Where  $a_{raw}$  is the raw angle provided by the MagAlpha front end.

The parameter Z(15:0), which is zero by default, is the complementary angle of the zero setting. In decimals, it can be written as shown in Equation (3):

$$a_0 = 2^{16} - Z(15:0) \quad (3)$$

Table 10 shows the zero setting parameter.

**Table 10: Zero Setting Parameter**

Z(15:0)	Zero pos. $a_0$ (16-bit dec)	Zero pos. $a_0$ (deg)
0	65536	360.000
1	65535	359.995
2	65534	359.989
...	...	...
65534	2	0.011
65535	1	0.005

### Example

To set the zero position to 20 degrees, the Z(15:0) parameter shall be equal to the complementary angle and can be calculated with Equation (4):

$$Z(15:0) = 2^{16} - \frac{20 \text{ deg}}{360 \text{ deg}} 2^{16} = 61895 \quad (4)$$

In binary, it is written as 1111 0001 1100 0111.

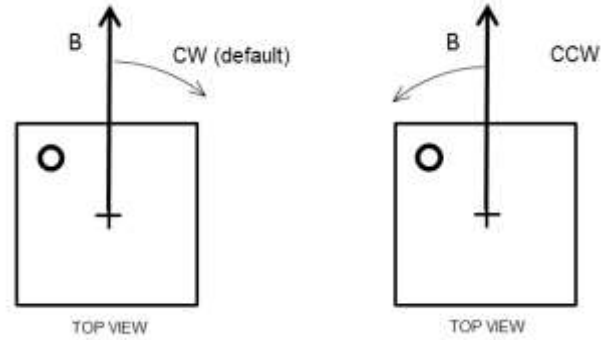
Table 11 shows the content of the registers 0 and 1.

**Table 11: Register 0 and 1 Content**

Reg	Bit 7	Bit 6	Bit 5	Bit 4	Bit 3	Bit 2	Bit 1	Bit 0
0	1	1	0	0	0	1	1	1
1	1	1	1	1	0	0	0	1

### Rotation Direction

By default, when looking at the top of the package, the angle increases when the magnetic field rotates clockwise (CW) (see Figure 18 and Table 12).



**Figure 18: Positive Rotation Direction of the Magnetic Field**

**Table 12: Rotation Direction Parameter**

RD	Positive Direction
0	Clockwise (CW)
1	Counterclockwise (CCW)

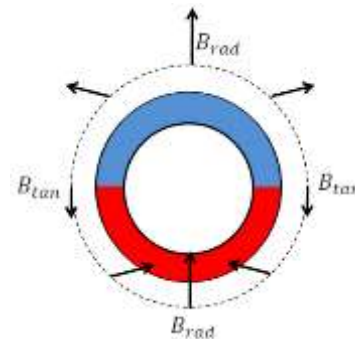
### BCT Settings (Bias Current Trimming)

#### Side Shaft

When the MA704 is mounted on the side of the magnet, the relation between the field angle and the mechanical angle is no longer directly linear. This effect is related to the fact that the tangential magnetic field is usually smaller than the radial field. Define the field ratio  $k$  with Equation (5):

$$k = B_{rad} / B_{tan} \quad (5)$$

Where  $B_{rad}$  and  $B_{tan}$  are the maximum radial and tangential magnetic fields (see Figure 19).



**Figure 19: Side-Shaft Field**

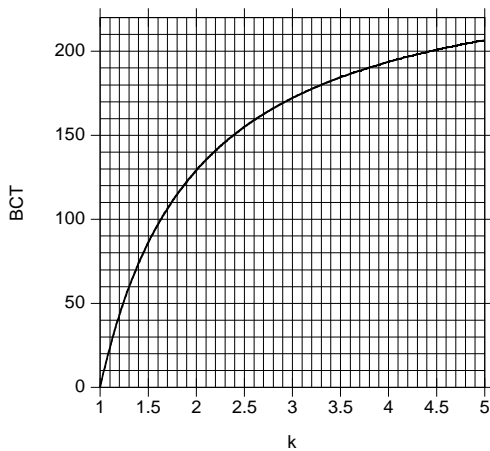
The ratio  $k$  depends on the magnet geometry and the distance to the sensor. Having a  $k$  ratio different than 1 results in the sensor output response not being linear with respect to the mechanical angle. Note that the error curve has the shape of a double sinewave (see Figure 21).  $E$  is the amplitude of this error.

The X-axis or the Y-axis bias current can be reduced by programming in order to recover an equal Hall signal for all angles and therefore suppress the error. The parameter ETX and ETY controls the direction in which sensitivity is reduced. The current reduction is set by the parameter bias current trimming BCT(7:0), which is an integer from 0 to 255.

In side-shaft configuration (i.e.: the sensor center is located beyond the magnet outer diameter),  $k$  is greater than 1. For optimum compensation, the sensitivity of the radial axis should be reduced by setting the BCT parameter as shown in Equation (6):

$$BCT(7:0) = 258 \left( 1 - \frac{1}{k} \right) \quad (6)$$

The graph in Figure 20 shows the optimum BCT value for a particular  $k$  ratio.



**Figure 20: Relation between the  $k$  Ratio and the Optimum BCT to Recover Linearity**

Table 13 shows some typical BCT values.

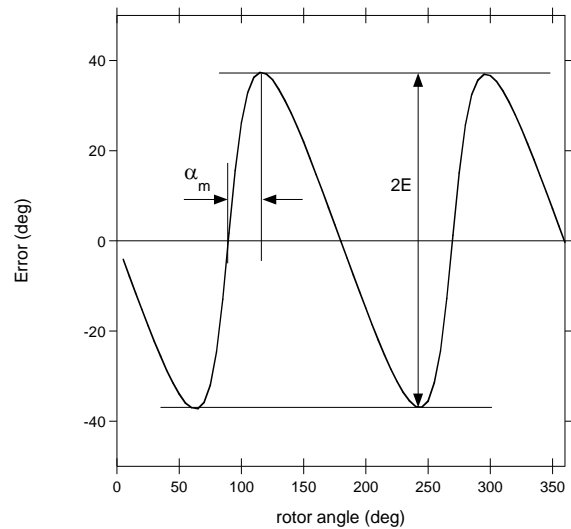
**Table 13: Example of BCT Settings**

E (deg)	Magnet Ratio $k$	BCT(7:0)
0	1.0	0
11.5	1.5	86
19.5	2.0	129
25.4	2.5	155
30.0	3.0	172
33.7	3.5	184
36.9	4.0	194
39.5	4.5	201
41.8	5.0	207

**Determining  $k$  with the MagAlpha**

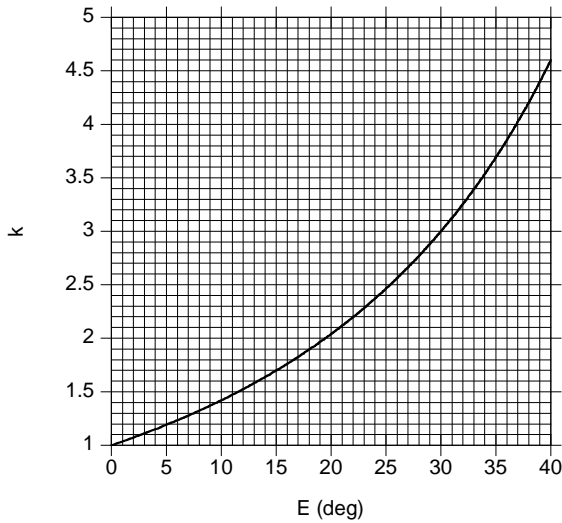
It is possible to deduce the  $k$  ratio from the error curve obtained with the default BCT setting (BCT = 0). For this purpose, rotate the magnet over one revolution and record the MagAlpha output. Then plot the error curve (the MagAlpha output minus the real mechanical position vs the real mechanical position) and extract two parameters: the maximum error  $E$  and the position of this maximum with respect to a zero crossing  $a_m$  (see Figure 21).  $k$  can be calculated with Equation (7):

$$k = \frac{\tan(E + a_m)}{\tan(a_m)} \quad (7)$$



**Figure 21: Error Curve in Side-Shaft Configuration with BCT = 0**

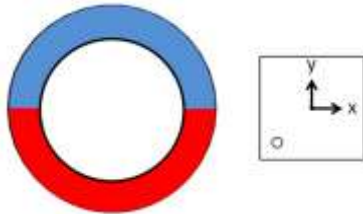
Some examples are given in Table 13. Alternatively, the  $k$  parameter can be obtained from the graph of Figure 22.



**Figure 22: Relation between the Error Measured with BCT = 0 and the Magnet Ratio *k***

### Sensor Orientation

From the dot marked on the package, it is possible to know whether the radial field is aligned with the sensor coordinate X or Y (see Figure 23).



**Figure 23: Package Top View with X and Y Axes**

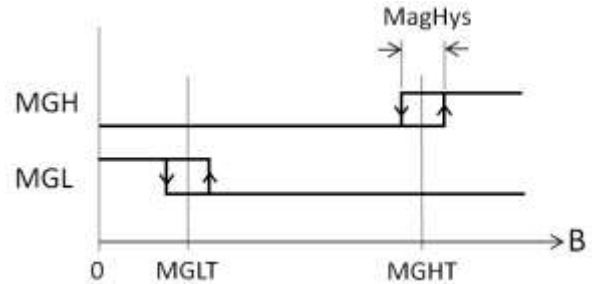
Determine which axis needs to be reduced (see the qualitative field distribution around a ring in Figure 19). For instance, with the arrangement depicted in Figure 23, the field along the sensor Y direction is tangential and weaker. The X-axis should be reduced (ETX = 1 and ETY = 0). Note that if both ETX and ETY are set to 1, the current bias is reduced in both directions the same way (i.e.: without side-shaft correction) (see Table 14).

**Table 14: Trimming Direction Parameters**

ETX	Enable Trimming of the X-Axis
0	Disabled
1	Enabled
ETY	Enable Trimming of the Y-Axis
0	Disabled
1	Enabled

### Magnetic Field Thresholds

The magnetic flags (MGL and MGH) indicate that the magnetic field at the sensor position is out a range defined by the lower (MGLT) and upper magnetic field thresholds (MGHT) (see Figure 24).



**Figure 24: MGH and MGL Signals as a Function of the Field Strength**

MagHys, the typical hysteresis on the signals MGH and MGL is 6mT. The MGLT and MGHT thresholds are coded on three bits and stored in register 6 (see Table 15).

**Table 15: Register 6**

Register 6							
Bit 7	Bit 6	Bit 5	Bit 4	Bit 3	Bit 2	Bit 1	Bit 0
MGLT			MGHT			-	-

The 3-bit values of MGLT and MGHT correspond to the magnetic field (see Table 16).

**Table 16: MGLT and MGHT: Binary to mT Relation**

MGLT or MGHT <sup>(8)</sup>	Field threshold in mT <sup>(7)</sup>	
	From low to high magnetic field	From high to low magnetic field
000	26	20
001	41	35
010	56	50
011	70	64
100	84	78
101	98	92
110	112	106
111	126	120

**NOTES:**

- 7) Valid for VDD=3.3V. If different then field threshold is scaled by the factor VDD/3.3V.
- 8) MGLT can have a larger value than MGHT.

The alarm flags MGL and MGH are available to be read in register 27 (bit 6, bit 7), and their logic state is also given at the digital output pins 11 and 16.

To read the MGL and MGH flags by SPI send the 8-bit command write into register 27:

command	reg. address	MSB	value	LSB
0 1 0	1 1 0 1 1	0 0 0 0 0 0 0 0		

The MA704 answers with the register 27 content in the next transmission:

R[7:0]							
MGL	MGH	x	x	x	x	x	x

### ABZ Incremental Encoder Output

The MA704 ABZ output emulates a 10-bit incremental encoder (such as an optical encoder) providing logic pulses in quadrature (see Figure 25). Compared to signal A, signal B is shifted by a quarter of the pulse period. Over one revolution, signal A pulses *N* times, where *N* is programmable from 1 to 256 pulses per revolution. The number of pulses per channel per revolution is programmed by setting the parameter PPT, which consists of eight bits split between registers 0x4 and 0x5 (see Table 7). The factory default value is 256. Table 17 describes how to program PPT(7:0) to set the required resolution.

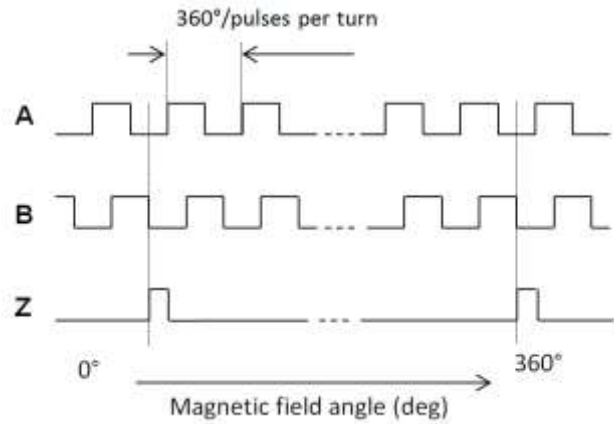
**Table 17: PPT**

PPT(7:0)	Pulses per Turn	Edges per Turn	
00000000	1	4	MIN
00000001	2	8	
00000010	3	12	
00000011	4	16	
...	...	...	...
11111100	253	1012	
11111101	254	1016	
11111110	255	1020	
11111111	256	1024	MAX

For example, to set 120 pulses per revolution (i.e. 480 edges), set PPT to  $120 - 1 = 119$ . In binary: 01110111. Registers 4 and 5 must be set as shown in Table 18.

**Table 18: Example PPT setting for 120 pulses**

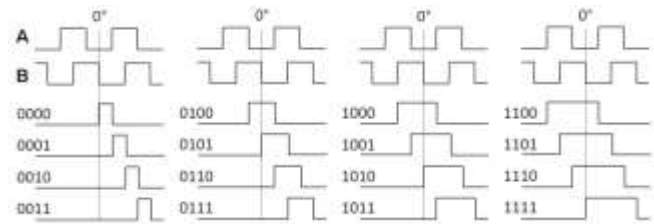
	B7	B6	B5	B4	B3	B2	B1	B0
R4	1	1	0	0	0	0	0	0
R5	0	0	0	1	1	1	0	1



**Figure 25: Timing of the ABZ Output**

Signal Z (zero or index) raises only once per turn at the zero-angle position.

The position and length of the Z pulse is programmable via bits ILIP(3:0) in register 0x5 (see Figure 26).

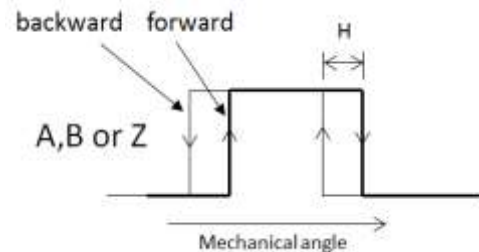


**Figure 26: ILIP Parameter Effect on Index Shape**

By default, the ILIP parameter is 0000. The index rising edge is aligned with the channel B falling edge. The index length is half the A or B pulse length.

### ABZ Hysteresis

A hysteresis larger than the output noise is introduced on the ABZ output to avoid any spurious transitions (see Figure 27).



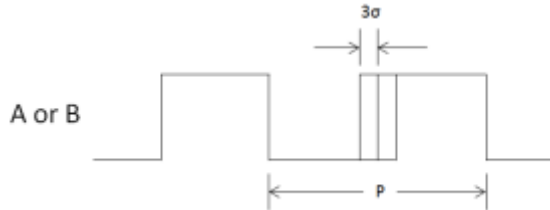
**Figure 27: Hysteresis of the Incremental Output**



### ABZ Jitter

The ABZ state is updated at a frequency of 16MHz, enabling accurate operation up to a very high rpm (above 10<sup>5</sup> rpm).

The jitter characterizes how far a particular ABZ edge can occur at an angular position different from the ideal position (see Figure 28).



**Figure 28: ABZ Jitter**

The measurable jitter is composed by a systematic jitter (i.e.: always the same deviation at a given angle) and a random jitter.

The random jitter reflects the sensor noise. Therefore, the edge distribution is the same as the SPI output noise. Like the sensor resolution, it is defined as the 3σ width of this distribution.

In fact, the random jitter is a function of the rotation speed. At a lower speed, the random jitter is smaller than the sensor noise.

This is a consequence of the fact that the probability of measuring an edge at a certain distance from the ideal position depends on the number of ABZ updates at this position.

The minimum field for ABZ reading is 30mT.

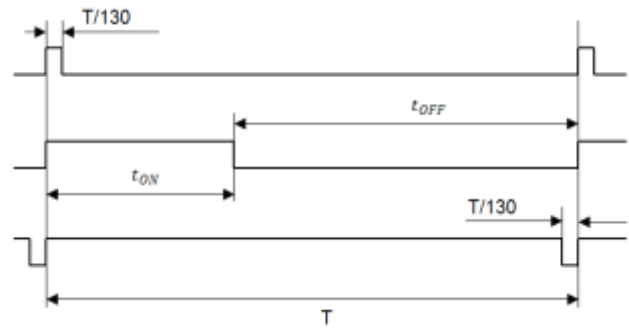
### PWM Absolute Output

This output provides a logic signal with a duty cycle proportional to the angle of the magnetic field. The PWM frequency is indicated in the General Characteristics table on page 5. The duty cycle is bounded by a minimum value (1/34 of the period) and a maximum value (33/34 of the period) (see Figure 29), so the duty cycle varies from 1/34 to 33/24 with a resolution of 10 bits. The angle can be retrieved by measuring the on time. Since the absolute PWM frequency can vary from chip to chip or with the temperature, accurate angle detection requires the measurement of the duty cycle (i.e.: the measurement of both the on time ( $t_{on}$ ) and the off time ( $t_{off}$ )).

The angle can be calculated with Equation (8):

$$angle(in\ deg) = 360 \frac{1}{32} \left( 34 \frac{t_{ON}}{t_{ON} + t_{OFF}} - 1 \right) \quad (8)$$

Figure 29 shows one period of the PWM signal. The period T is 1/F<sub>pwm</sub>, where F<sub>pwm</sub> is the PWM frequency indicated in the general characteristic table.



**Top Signal: 0°  
Bottom Signal: Full Scale (i.e.: 360°(1-1/4096))  
Figure 29: PWM Output Timing**

TYPICAL APPLICATION CIRCUITS

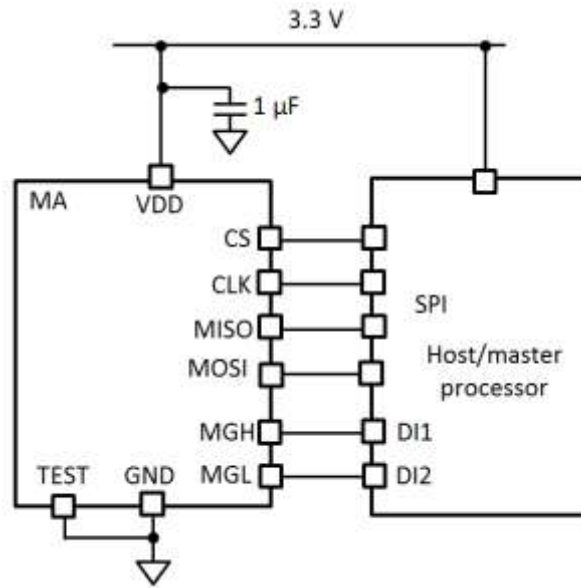


Figure 30: Typical Configurations Using SPI Interface and MGH/MGL Signals

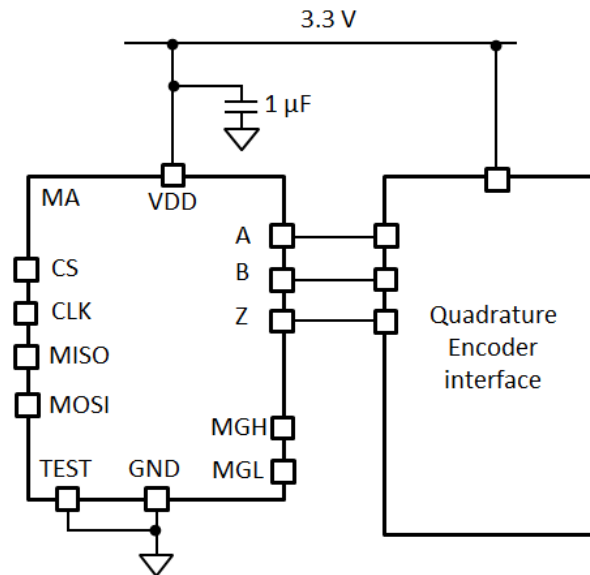
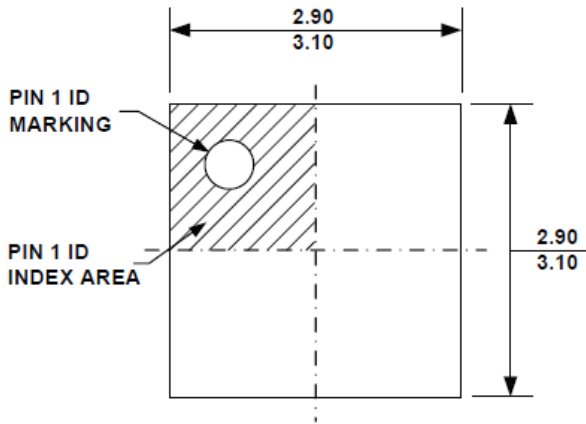


Figure 31: Typical Configuration Using ABZ Interface

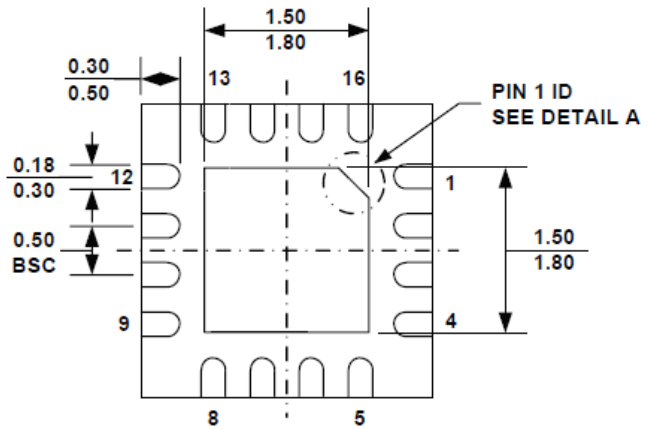


**PACKAGE INFORMATION**

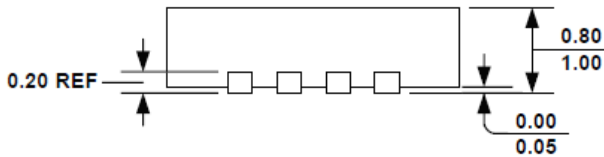
**QFN-16 (3mmx3mm)**



**TOP VIEW**

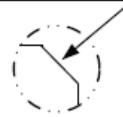


**BOTTOM VIEW**

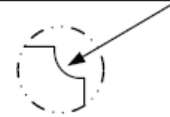


**SIDE VIEW**

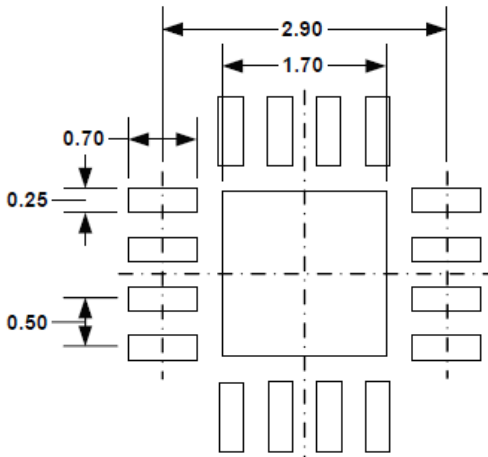
**PIN 1 ID OPTION A**  
0.30x45° TYP.



**PIN 1 ID OPTION B**  
R0.20 TYP.



**DETAIL A**



**RECOMMENDED LAND PATTERN**

**NOTE:**

- 1) ALL DIMENSIONS ARE IN MILLIMETERS.
- 2) EXPOSED PADDLE SIZE DOES NOT INCLUDE MOLD FLASH.
- 3) LEAD COPLANARITY SHALL BE 0.10 MILLIMETER MAX.
- 4) DRAWING CONFORMS TO JEDEC MO-220, VARIATION VEED-4
- 5) DRAWING IS NOT TO SCALE.

APPENDIX A: DEFINITIONS

- Effective Resolution ( $3\sigma$  noise level)** This is the smallest angle increment distinguishable from the noise. The resolution is measured by computing three times  $\sigma$  (the standard deviation in degrees) taken over 1,000 data points at a constant position. The resolution in bits is obtained with:  $\log_2(360/6\sigma)$ .
- Refresh Rate** Rate at which new data points are stored in the output buffer.
- ABZ Update Rate** Rate at which a new ABZ state is computed. The inverse of this rate is the minimum time between two ABZ edges.
- Latency** The time elapsed between the instant when the data is ready to be read and the instant at which the shaft passes that position. The lag in degrees is  $lag = latency \cdot v$ , where  $v$  is the angular velocity in deg/s.
- Power-Up Time** Time until the sensor delivers valid data starting at power up.
- Integral Non-Linearity (INL)** Maximum deviation between the average sensor output (at a fixed position) and the true mechanical angle.

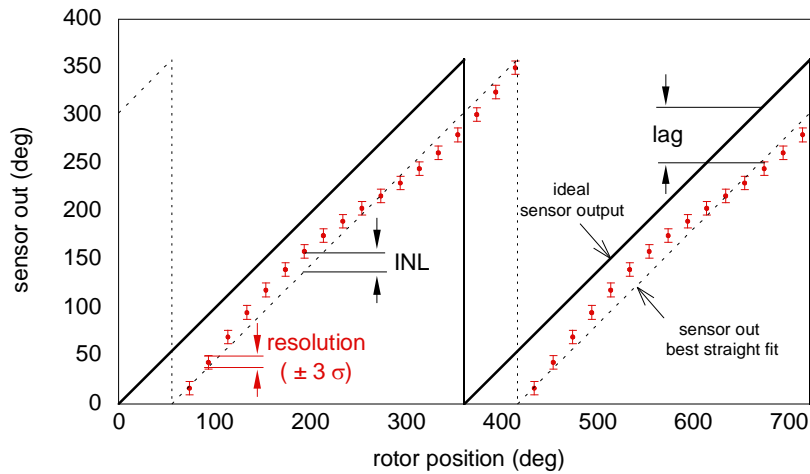


Figure A1: Resolution, INL, Lag

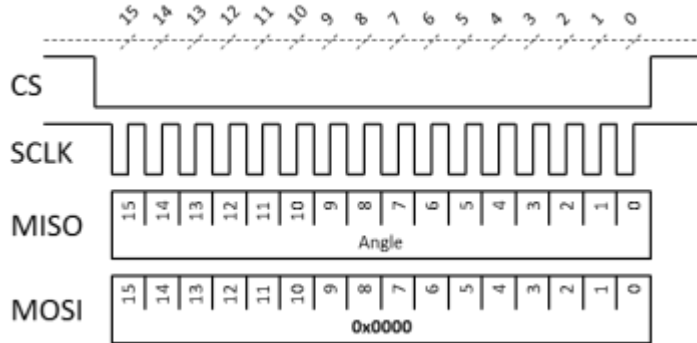
INL can be obtained from the error curve  $err(\alpha) = out(\alpha) - \alpha$ , where  $out(\alpha)$  is the average over 1000 sensor output and  $\alpha$  is the mechanical angle indicated by a high precision encoder ( $<0.001$  deg). INL is then computed with Equation (A1):

$$INL = \frac{\max(err(a)) - \min(err(a))}{2} \tag{A1}$$

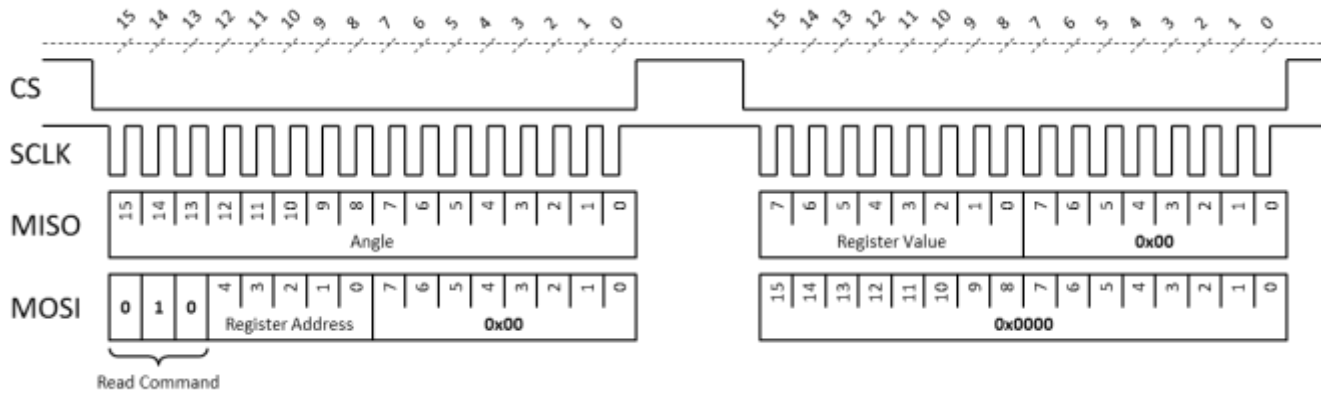
- Drift** Angle variation rate when one parameter is changed (e.g.: temperature, VDD) and all the others, including the shaft angle, are maintained constant.

## APPENDIX B: SPI COMMUNICATION CHEATSHEET

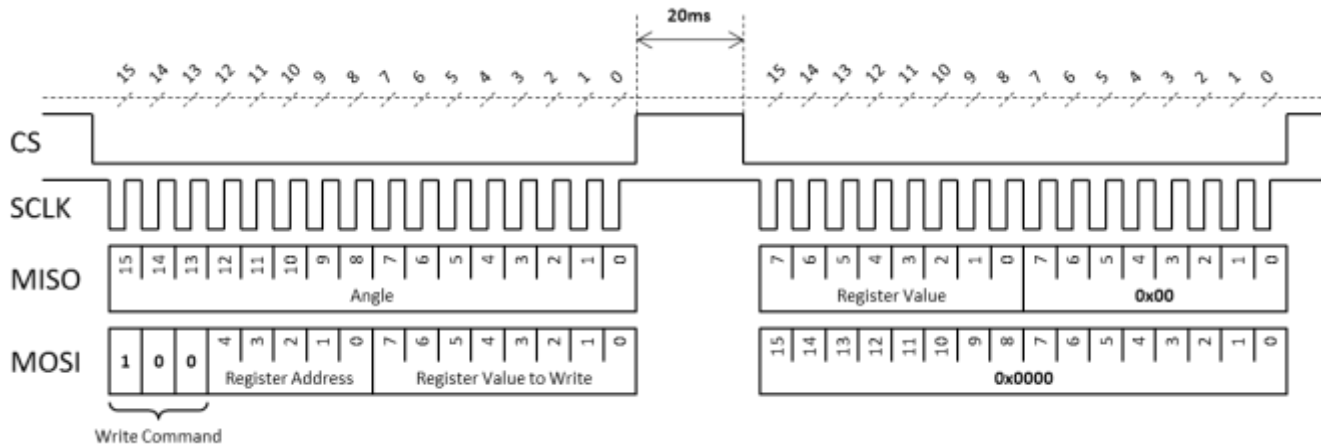
### Read Angle



### Read Register



### Write Register



**NOTICE:** The information in this document is subject to change without notice. Users should warrant and guarantee that third party Intellectual Property rights are not infringed upon when integrating MPS products into any application. MPS will not assume any legal responsibility for any said applications.