

# Octal D-Type Flip-Flop with 3-State Outputs

## MC74AC374, MC74ACT374

The MC74AC374/74ACT374 is a high-speed, low-power octal D-type flip-flop featuring separate D-type inputs for each flip-flop and 3-state outputs for bus-oriented applications. A buffered Clock (CP) and Output Enable ( $\overline{OE}$ ) are common to all flip-flops.

### Features

- Buffered Positive Edge-Triggered Clock
- 3-State Outputs for Bus-Oriented Applications
- Outputs Source/Sink 24 mA
- See MC74AC273 for Reset Version
- See MC74AC377 for Clock Enable Version
- See MC74AC373 for Transparent Latch Version
- See MC74AC574 for Broadside Pinout Version
- See MC74AC564 for Broadside Pinout Version with Inverted Outputs
- 'ACT374 Has TTL Compatible Inputs
- These are Pb-Free Devices

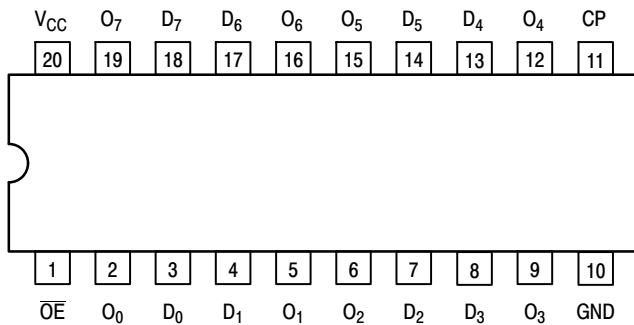

Figure 1. Pinout: 20 Lead Packages Conductors  
(Top View)

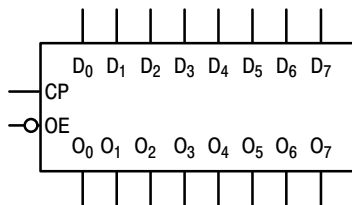
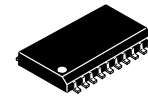

Figure 2. Logic Symbol

### PIN ASSIGNMENT

| PIN                            | FUNCTION                    |
|--------------------------------|-----------------------------|
| D <sub>0</sub> -D <sub>7</sub> | Data Inputs                 |
| CP                             | Clock Pulse Input           |
| $\overline{OE}$                | 3-State Output Enable Input |
| O <sub>0</sub> -O <sub>7</sub> | 3-State Outputs             |

### MARKING DIAGRAMS



1  
SOIC-20W  
DW SUFFIX  
CASE 751D

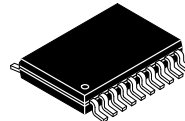
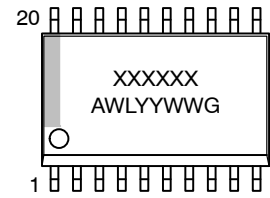

1  
TSSOP-20  
DT SUFFIX  
CASE 948E

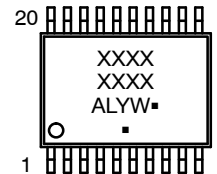

XXXXXX = Specific Device Code  
A = Assembly Location  
WL, L = Wafer Lot  
YY, Y = Year  
WW, W = Work Week  
G or ■ = Pb-Free Package  
(Note: Microdot may be in either location)

### DEVICE MARKING INFORMATION

See general marking information in the device marking section on page 6 of this data sheet.

# MC74AC374, MC74ACT374

## TRUTH TABLE

| Inputs         |    |                 | Outputs        |
|----------------|----|-----------------|----------------|
| D <sub>n</sub> | CP | $\overline{OE}$ | O <sub>n</sub> |
| H              | ⌄  | L               | H              |
| L              | ⌄  | L               | L              |
| X              | X  | H               | Z              |

H = HIGH Voltage Level  
 L = LOW Voltage Level  
 X = Immaterial  
 Z = High Impedance  
 ⌄ = LOW-to-HIGH Transition

## FUNCTIONAL DESCRIPTION

The MC74AC374/74ACT374 consists of eight edge-triggered flip-flops with individual D-type inputs and 3-state true outputs. The buffered clock and buffered Output Enable are common to all flip-flops. The eight flip-flops will store the state of their individual D inputs that meet the setup and hold time requirements on the LOW-to-HIGH Clock (CP) transition. With the Output Enable ( $\overline{OE}$ ) LOW, the contents of the eight flip-flops are available at the outputs. When the  $\overline{OE}$  is HIGH, the outputs go to the high impedance state. Operation of the  $\overline{OE}$  input does not affect the state of the flip-flops.

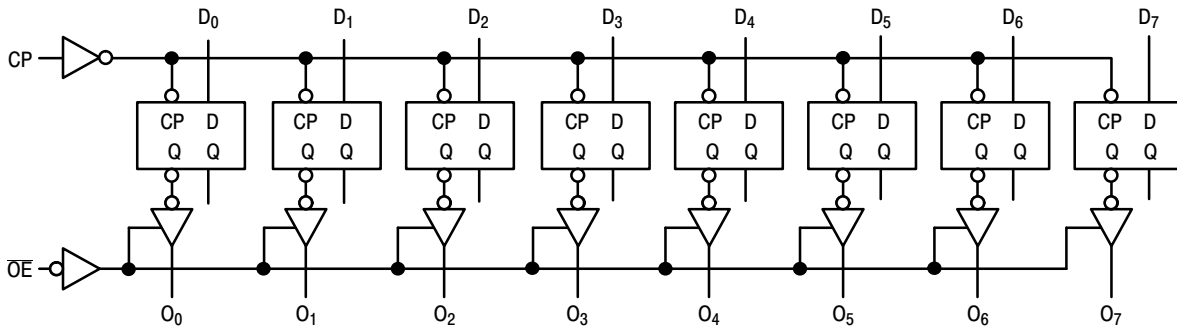

NOTE: That this diagram is provided only for the understanding of logic operations and should not be used to estimate propagation delays.

Figure 3. Logic Diagram

# MC74AC374, MC74ACT374

## MAXIMUM RATINGS

| Symbol               | Parameter                                       | Value  | Unit       |
|----------------------|---|--|------------|
| V <sub>CC</sub>      | DC Supply Voltage (Referenced to GND)           | -0.5 to +6.5   | V          |
| V <sub>IN</sub>      | DC Input Voltage (Referenced to GND)            | -0.5 to V <sub>CC</sub> +0.5   | V          |
| V <sub>OUT</sub>     | DC Output Voltage (Referenced to GND) (Note 1)  | -0.5 to V <sub>CC</sub> +0.5   | V          |
| I <sub>IK</sub>      | DC Input Diode Current                          | ±20  | mA         |
| I <sub>OK</sub>      | DC Output Diode Current                         | ±50  | mA         |
| I <sub>OUT</sub>     | DC Output Sink/Source Current                   | ±50  | mA         |
| I <sub>CC</sub>      | DC Supply Current, per Output Pin               | ±50  | mA         |
| I <sub>GND</sub>     | DC Ground Current, per Output Pin               | ±100   | mA         |
| T <sub>STG</sub>     | Storage Temperature Range                       | -65 to +150  | °C         |
| T <sub>L</sub>       | Lead temperature, 1 mm from Case for 10 Seconds | 260  | °C         |
| T <sub>J</sub>       | Junction Temperature Under Bias                 | 140  | °C         |
| θ <sub>JA</sub>      | Thermal Resistance (Note 2)                     | SOIC<br>TSSOP<br>96<br>150   | °C/W       |
| MSL                  | Moisture Sensitivity                            | Level 1  |            |
| F <sub>R</sub>       | Flammability Rating                             | Oxygen Index: 30% – 35%<br>UL 94 V-0 @ 0.125 in                                |            |
| V <sub>ESD</sub>     | ESD Withstand Voltage                           | Human Body Model (Note 3)<br>Charged Device Model (Note 4)<br>> 2000<br>> 1000 | V          |
| I <sub>Latchup</sub> | Latchup Performance                             | Above V <sub>CC</sub> and Below GND at 85°C (Note 5)                           | ±100<br>mA |

Stresses exceeding those listed in the Maximum Ratings table may damage the device. If any of these limits are exceeded, device functionality should not be assumed, damage may occur and reliability may be affected.

1. I<sub>OUT</sub> absolute maximum rating must be observed.
2. The package thermal impedance is calculated in accordance with JESD 51-7.
3. Tested to EIA/JESD22-A114-A.
4. Tested to JESD22-C101-A.
5. Tested to EIA/JESD78.

## RECOMMENDED OPERATING CONDITIONS

| Symbol                             | Parameter   | Min                     | Typ | Max             | Unit |      |
|------------------------------------|---|-------------------------|-----|-----------------|------|------|
| V <sub>CC</sub>                    | Supply Voltage  | 'AC                     | 2.0 | 5.0             | 6.0  | V    |
|                                    |   | 'ACT                    | 4.5 | 5.0             | 5.5  |      |
| V <sub>IN</sub> , V <sub>OUT</sub> | DC Input Voltage, Output Voltage (Ref. to GND)                          | 0                       |     | V <sub>CC</sub> | V    |      |
| t <sub>r</sub> , t <sub>f</sub>    | Input Rise and Fall Time (Note 1)<br>'AC Devices except Schmitt Inputs  | V <sub>CC</sub> @ 3.0 V | -   | 150             | -    | ns/V |
|                                    |   | V <sub>CC</sub> @ 4.5 V | -   | 40              | -    |      |
|                                    |   | V <sub>CC</sub> @ 5.5 V | -   | 25              | -    |      |
| t <sub>r</sub> , t <sub>f</sub>    | Input Rise and Fall Time (Note 2)<br>'ACT Devices except Schmitt Inputs | V <sub>CC</sub> @ 4.5 V | -   | 10              | -    | ns/V |
|                                    |   | V <sub>CC</sub> @ 5.5 V | -   | 8.0             | -    |      |
| T <sub>A</sub>                     | Operating Ambient Temperature Range                                     | -40                     | 25  | 85              | °C   |      |
| I <sub>OH</sub>                    | Output Current – High   | -                       | -   | -24             | mA   |      |
| I <sub>OL</sub>                    | Output Current – Low  | -                       | -   | 24              | mA   |      |

Functional operation above the stresses listed in the Recommended Operating Ranges is not implied. Extended exposure to stresses beyond the Recommended Operating Ranges limits may affect device reliability.

1. V<sub>IN</sub> from 30% to 70% V<sub>CC</sub>; see individual Data Sheets for devices that differ from the typical input rise and fall times.
2. V<sub>IN</sub> from 0.8 V to 2.0 V; see individual Data Sheets for devices that differ from the typical input rise and fall times.

# MC74AC374, MC74ACT374

## DC CHARACTERISTICS

| Symbol           | Parameter                         | V <sub>CC</sub><br>(V) | 74AC                   |                   | 74AC                            |  | Unit | Conditions  |
|------------------|-----------------------------------|------------------------|------------------------|-------------------|---------------------------------|--|------|---|
|                  |                                   |                        | T <sub>A</sub> = +25°C |                   | T <sub>A</sub> = -40°C to +85°C |  |      |   |
|                  |                                   |                        | Typ                    | Guaranteed Limits |                                 |  |      |   |
| V <sub>IH</sub>  | Minimum High Level Input Voltage  | 3.0                    | 1.5                    | 2.1               | 2.1                             |  | V    | V <sub>OUT</sub> = 0.1 V<br>or V <sub>CC</sub> - 0.1 V  |
|                  |                                   | 4.5                    | 2.25                   | 3.15              | 3.15                            |  |      |   |
|                  |                                   | 5.5                    | 2.75                   | 3.85              | 3.85                            |  |      |   |
| V <sub>IL</sub>  | Maximum Low Level Input Voltage   | 3.0                    | 1.5                    | 0.9               | 0.9                             |  | V    | V <sub>OUT</sub> = 0.1 V<br>or V <sub>CC</sub> - 0.1 V  |
|                  |                                   | 4.5                    | 2.25                   | 1.35              | 1.35                            |  |      |   |
|                  |                                   | 5.5                    | 2.75                   | 1.65              | 1.65                            |  |      |   |
| V <sub>OH</sub>  | Minimum High Level Output Voltage | 3.0                    | 2.99                   | 2.9               | 2.9                             |  | V    | I <sub>OUT</sub> = -50 μA   |
|                  |                                   | 4.5                    | 4.49                   | 4.4               | 4.4                             |  |      |   |
|                  |                                   | 5.5                    | 5.49                   | 5.4               | 5.4                             |  |      |   |
|                  |                                   | 3.0                    | -                      | 2.56              | 2.46                            |  | V    | *V <sub>IN</sub> = V <sub>IL</sub> or V <sub>IH</sub><br>-12 mA<br>I <sub>OH</sub> -24 mA<br>-24 mA   |
|                  |                                   | 4.5                    | -                      | 3.86              | 3.76                            |  |      |   |
|                  |                                   | 5.5                    | -                      | 4.86              | 4.76                            |  |      |   |
| V <sub>OL</sub>  | Maximum Low Level Output Voltage  | 3.0                    | 0.002                  | 0.1               | 0.1                             |  | V    | I <sub>OUT</sub> = 50 μA  |
|                  |                                   | 4.5                    | 0.001                  | 0.1               | 0.1                             |  |      |   |
|                  |                                   | 5.5                    | 0.001                  | 0.1               | 0.1                             |  |      |   |
|                  |                                   | 3.0                    | -                      | 0.36              | 0.44                            |  | V    | *V <sub>IN</sub> = V <sub>IL</sub> or V <sub>IH</sub><br>12 mA<br>I <sub>OL</sub> 24 mA<br>24 mA  |
|                  |                                   | 4.5                    | -                      | 0.36              | 0.44                            |  |      |   |
|                  |                                   | 5.5                    | -                      | 0.36              | 0.44                            |  |      |   |
| I <sub>IN</sub>  | Maximum Input Leakage Current     | 5.5                    | -                      | ±0.1              | ±1.0                            |  | μA   | V <sub>I</sub> = V <sub>CC</sub> , GND  |
| I <sub>OZ</sub>  | Maximum 3-State Current           | 5.5                    | -                      | ±0.5              | ±5.0                            |  | μA   | V <sub>I</sub> (OE) = V <sub>IL</sub> , V <sub>IH</sub><br>V <sub>I</sub> = V <sub>CC</sub> , GND<br>V <sub>O</sub> = V <sub>CC</sub> , GND |
| I <sub>OLD</sub> | †Minimum Dynamic Output Current   | 5.5                    | -                      | -                 | 75                              |  | mA   | V <sub>OLD</sub> = 1.65 V Max   |
| I <sub>OHD</sub> |                                   | 5.5                    | -                      | -                 | -75                             |  | mA   | V <sub>OHD</sub> = 3.85 V Min   |
| I <sub>CC</sub>  | Maximum Quiescent Supply Current  | 5.5                    | -                      | 8.0               | 80                              |  | μA   | V <sub>IN</sub> = V <sub>CC</sub> or GND  |

\*All outputs loaded; thresholds on input associated with output under test.

†Maximum test duration 2.0 ms, one output loaded at a time.

NOTE: I<sub>IN</sub> and I<sub>CC</sub> @ 3.0 V are guaranteed to be less than or equal to the respective limit @ 5.5 V V<sub>CC</sub>.

# MC74AC374, MC74ACT374

## AC CHARACTERISTICS (For Figures and Waveforms – See AND8277/D at www.onsemi.com)

| Symbol           | Parameter                                 | V <sub>CC</sub> *<br>(V) | 74AC   |             |             | 74AC   |              | Unit | Fig. No. |
|------------------|---|--------------------------|--|-------------|-------------|--|--------------|------|----------|
|                  |   |                          | T <sub>A</sub> = +25°C<br>C <sub>L</sub> = 50 pF |             |             | T <sub>A</sub> = -40°C<br>to +85°C<br>C <sub>L</sub> = 50 pF |              |      |          |
|                  |   |                          | Min  | Typ         | Max         | Min  | Max          |      |          |
| f <sub>max</sub> | Maximum Clock Frequency                   | 3.3<br>5.0               | 60<br>100  | 110<br>155  | –<br>–      | 60<br>100  | –<br>–       | MHz  | 3–3      |
| t <sub>PLH</sub> | Propagation Delay<br>CP to O <sub>n</sub> | 3.3<br>5.0               | 3.0<br>2.5                                       | 11<br>8.0   | 13.5<br>9.5 | 1.5<br>1.5   | 15.5<br>10.5 | ns   | 3–6      |
| t <sub>PHL</sub> | Propagation Delay<br>CP to O <sub>n</sub> | 3.3<br>5.0               | 2.5<br>2.0                                       | 10<br>7.0   | 12.5<br>9.0 | 2.0<br>1.5   | 14<br>10     | ns   | 3–6      |
| t <sub>PZH</sub> | Output Enable Time                        | 3.3<br>5.0               | 3.0<br>2.0                                       | 9.5<br>7.0  | 11.5<br>8.5 | 1.5<br>1.0   | 13<br>9.5    | ns   | 3–7      |
| t <sub>PZL</sub> | Output Enable Time                        | 3.3<br>5.0               | 2.5<br>2.0                                       | 9.0<br>6.5  | 11.5<br>8.5 | 1.5<br>1.0   | 13<br>9.5    | ns   | 3–8      |
| t <sub>PHZ</sub> | Output Disable Time                       | 3.3<br>5.0               | 3.0<br>2.0                                       | 10.5<br>8.0 | 12.5<br>11  | 2.0<br>2.0   | 14.5<br>12.5 | ns   | 3–7      |
| t <sub>PLZ</sub> | Output Disable Time                       | 3.3<br>5.0               | 2.0<br>1.5                                       | 8.0<br>6.5  | 11.5<br>8.5 | 1.0<br>1.0   | 12.5<br>10   | ns   | 3–8      |

\*Voltage Range 3.3 V is 3.3 V ±0.3 V.  
Voltage Range 5.0 V is 5.0 V ±0.5 V.

## AC OPERATING REQUIREMENTS

| Symbol         | Parameter                                       | V <sub>CC</sub> *<br>(V) | 74AC   |                    | 74AC   |    | Unit | Fig. No. |
|----------------|---|--------------------------|--|--------------------|--|----|------|----------|
|                |   |                          | T <sub>A</sub> = +25°C<br>C <sub>L</sub> = 50 pF |                    | T <sub>A</sub> = -40°C<br>to +85°C<br>C <sub>L</sub> = 50 pF |    |      |          |
|                |   |                          | Typ  | Guaranteed Minimum |  |    |      |          |
| t <sub>s</sub> | Setup Time, HIGH or LOW<br>D <sub>n</sub> to CP | 3.3<br>5.0               | 2.0<br>1.0                                       | 5.5<br>4.0         | 6.0<br>4.5   | ns | 3–9  |          |
| t <sub>h</sub> | Hold Time, HIGH or LOW<br>D <sub>n</sub> to CP  | 3.3<br>5.0               | -1.0<br>0  | 1.0<br>1.5         | 1.0<br>1.5   | ns | 3–9  |          |
| t <sub>w</sub> | CP Pulse Width<br>HIGH or LOW                   | 3.3<br>5.0               | 4.0<br>2.5                                       | 5.5<br>4.0         | 6.0<br>4.5   | ns | 3–6  |          |

\*Voltage Range 3.3 V is 3.3 V ±0.3 V.  
Voltage Range 5.0 V is 5.0 V ±0.5 V.

# MC74AC374, MC74ACT374

## DC CHARACTERISTICS

| Symbol            | Parameter                              | V <sub>CC</sub><br>(V) | 74ACT                  |                   | 74ACT                           |  | Unit | Conditions  |
|-------------------|--|------------------------|------------------------|-------------------|---------------------------------|--|------|---|
|                   |  |                        | T <sub>A</sub> = +25°C |                   | T <sub>A</sub> = -40°C to +85°C |  |      |   |
|                   |  |                        | Typ                    | Guaranteed Limits |                                 |  |      |   |
| V <sub>IH</sub>   | Minimum High Level Input Voltage       | 4.5                    | 1.5                    | 2.0               | 2.0                             |  | V    | V <sub>OUT</sub> = 0.1 V or V <sub>CC</sub> - 0.1 V   |
|                   |  | 5.5                    | 1.5                    | 2.0               | 2.0                             |  |      |   |
| V <sub>IL</sub>   | Maximum Low Level Input Voltage        | 4.5                    | 1.5                    | 0.8               | 0.8                             |  | V    | V <sub>OUT</sub> = 0.1 V or V <sub>CC</sub> - 0.1 V   |
|                   |  | 5.5                    | 1.5                    | 0.8               | 0.8                             |  |      |   |
| V <sub>OH</sub>   | Minimum High Level Output Voltage      | 4.5                    | 4.49                   | 4.4               | 4.4                             |  | V    | I <sub>OUT</sub> = -50 μA   |
|                   |  | 5.5                    | 5.49                   | 5.4               | 5.4                             |  |      |   |
|                   |  | 4.5                    | -                      | 3.86              | 3.76                            |  | V    | *V <sub>IN</sub> = V <sub>IL</sub> or V <sub>IH</sub><br>I <sub>OH</sub> = -24 mA   |
|                   |  | 5.5                    | -                      | 4.86              | 4.76                            |  |      |   |
| V <sub>OL</sub>   | Maximum Low Level Output Voltage       | 4.5                    | 0.001                  | 0.1               | 0.1                             |  | V    | I <sub>OUT</sub> = 50 μA  |
|                   |  | 5.5                    | 0.001                  | 0.1               | 0.1                             |  |      |   |
|                   |  | 4.5                    | -                      | 0.36              | 0.44                            |  | V    | *V <sub>IN</sub> = V <sub>IL</sub> or V <sub>IH</sub><br>I <sub>OL</sub> = 24 mA  |
|                   |  | 5.5                    | -                      | 0.36              | 0.44                            |  |      |   |
| I <sub>IN</sub>   | Maximum Input Leakage Current          | 5.5                    | -                      | ±0.1              | ±1.0                            |  | μA   | V <sub>I</sub> = V <sub>CC</sub> , GND  |
| ΔI <sub>CCT</sub> | Additional Max. I <sub>CC</sub> /Input | 5.5                    | 0.6                    | -                 | 1.5                             |  | mA   | V <sub>I</sub> = V <sub>CC</sub> - 2.1 V  |
| I <sub>OZ</sub>   | Maximum 3-State Current                | 5.5                    | -                      | ±0.5              | ±5.0                            |  | μA   | V <sub>I</sub> (OE) = V <sub>IL</sub> , V <sub>IH</sub><br>V <sub>I</sub> = V <sub>CC</sub> , GND<br>V <sub>O</sub> = V <sub>CC</sub> , GND |
| I <sub>OLD</sub>  | †Minimum Dynamic Output Current        | 5.5                    | -                      | -                 | 75                              |  | mA   | V <sub>OLD</sub> = 1.65 V Max   |
| I <sub>OHD</sub>  |  | 5.5                    | -                      | -                 | -75                             |  | mA   | V <sub>OHD</sub> = 3.85 V Min   |
| I <sub>CC</sub>   | Maximum Quiescent Supply Current       | 5.5                    | -                      | 8.0               | 80                              |  | μA   | V <sub>IN</sub> = V <sub>CC</sub> or GND  |

\*All outputs loaded; thresholds on input associated with output under test.

†Maximum test duration 2.0 ms, one output loaded at a time.

## AC CHARACTERISTICS (For Figures and Waveforms – See AND8277/D at [www.onsemi.com](http://www.onsemi.com))

| Symbol           | Parameter                              | V <sub>CC</sub> *<br>(V) | 74ACT  |     |      | 74ACT   |      | Unit | Fig. No. |
|------------------|--|--------------------------|--|-----|------|---|------|------|----------|
|                  |  |                          | T <sub>A</sub> = +25°C<br>C <sub>L</sub> = 50 pF |     |      | T <sub>A</sub> = -40°C to +85°C<br>C <sub>L</sub> = 50 pF |      |      |          |
|                  |  |                          | Min  | Typ | Max  | Min   | Max  |      |          |
| f <sub>max</sub> | Maximum Clock Frequency                | 5.0                      | 100  | 160 | -    | 90  | -    | MHz  | 3-3      |
| t <sub>PLH</sub> | Propagation Delay CP to O <sub>n</sub> | 5.0                      | 2.0  | 8.5 | 10   | 2.0   | 11.5 | ns   | 3-6      |
| t <sub>PHL</sub> | Propagation Delay CP to O <sub>n</sub> | 5.0                      | 2.0  | 8.0 | 9.5  | 1.5   | 11   | ns   | 3-6      |
| t <sub>PZH</sub> | Output Enable Time                     | 5.0                      | 2.0  | 8.0 | 9.5  | 1.5   | 10.5 | ns   | 3-7      |
| t <sub>PZL</sub> | Output Enable Time                     | 5.0                      | 1.5  | 8.0 | 9.0  | 1.5   | 10.5 | ns   | 3-8      |
| t <sub>PHZ</sub> | Output Disable Time                    | 5.0                      | 1.5  | 8.5 | 11.5 | 1.0   | 12.5 | ns   | 3-7      |
| t <sub>PLZ</sub> | Output Disable Time                    | 5.0                      | 1.5  | 7.0 | 8.5  | 1.0   | 10   | ns   | 3-8      |

\*Voltage Range 5.0 V is 5.0 V ±0.5 V.

# MC74AC374, MC74ACT374

## AC OPERATING REQUIREMENTS (For Figures and Waveforms – See AND8277/D at www.onsemi.com)

| Symbol         | Parameter                                       | V <sub>CC</sub> *<br>(V) | 74ACT  |                    | 74ACT  |  | Unit | Fig. No. |
|----------------|---|--------------------------|--|--------------------|--|--|------|----------|
|                |   |                          | T <sub>A</sub> = +25°C<br>C <sub>L</sub> = 50 pF |                    | T <sub>A</sub> = -40°C<br>to +85°C<br>C <sub>L</sub> = 50 pF |  |      |          |
|                |   |                          | Typ  | Guaranteed Minimum |  |  |      |          |
| t <sub>s</sub> | Setup Time, HIGH or LOW<br>D <sub>n</sub> to CP | 5.0                      | 1.0  | 5.0                | 5.5  |  | ns   | 3-9      |
| t <sub>h</sub> | Hold Time, HIGH or LOW<br>D <sub>n</sub> to CP  | 5.0                      | 0  | 1.5                | 1.5  |  | ns   | 3-9      |
| t <sub>w</sub> | CP Pulse Width<br>HIGH or LOW                   | 5.0                      | 2.5  | 5.0                | 5.0  |  | ns   | 3-6      |

\*Voltage Range 5.0 V is 5.0 V ±0.5 V.

## CAPACITANCE

| Symbol          | Parameter                     | Value<br>Typ | Unit | Test Conditions         |
|-----------------|-------------------------------|--------------|------|-------------------------|
| C <sub>IN</sub> | Input Capacitance             | 4.5          | pF   | V <sub>CC</sub> = 5.0 V |
| C <sub>PD</sub> | Power Dissipation Capacitance | 80           | pF   | V <sub>CC</sub> = 5.0 V |

## MC74AC374, MC74ACT374

### ORDERING INFORMATION

| Device          | Marking    | Package  | Shipping†          |
|-----------------|------------|----------|--------------------|
| MC74AC374DWG    | AC374      | SOIC-20  | 38 Units / Rail    |
| MC74AC374DWR2G  | AC374      | SOIC-20  | 1000 / Tape & Reel |
| MC74ACT374DWG   | ACT374     | SOIC-20  | 38 Units / Rail    |
| MC74ACT374DWR2G | ACT374     | SOIC-20  | 1000 / Tape & Reel |
| MC74AC374DTR2G  | AC<br>374  | TSSOP-20 | 2500 / Tape & Reel |
| MC74ACT374DTR2G | ACT<br>374 | TSSOP-20 | 2500 / Tape & Reel |

†For information on tape and reel specifications, including part orientation and tape sizes, please refer to our Tape and Reel Packaging Specifications Brochure, BRD8011/D.



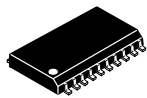

SCALE 1:1

SOIC-20 WB  
CASE 751D-05  
ISSUE H

DATE 22 APR 2015

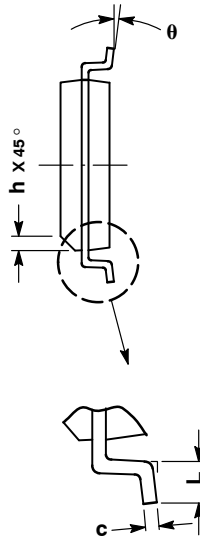
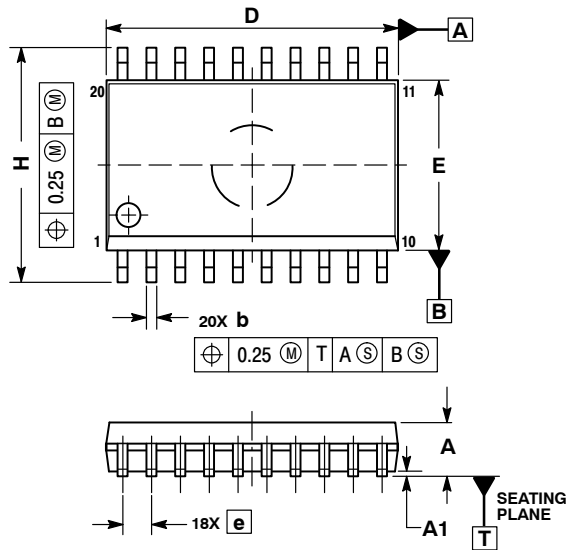

NOTES:

1. DIMENSIONS ARE IN MILLIMETERS.
2. INTERPRET DIMENSIONS AND TOLERANCES PER ASME Y14.5M, 1994.
3. DIMENSIONS D AND E DO NOT INCLUDE MOLD PROTRUSION.
4. MAXIMUM MOLD PROTRUSION 0.15 PER SIDE.
5. DIMENSION B DOES NOT INCLUDE DAMBAR PROTRUSION. ALLOWABLE PROTRUSION SHALL BE 0.13 TOTAL IN EXCESS OF B DIMENSION AT MAXIMUM MATERIAL CONDITION.

| DIM | MILLIMETERS |       |
|-----|-------------|-------|
|     | MIN         | MAX   |
| A   | 2.35        | 2.65  |
| A1  | 0.10        | 0.25  |
| b   | 0.35        | 0.49  |
| c   | 0.23        | 0.32  |
| D   | 12.65       | 12.95 |
| E   | 7.40        | 7.60  |
| e   | 1.27 BSC    |       |
| H   | 10.05       | 10.55 |
| h   | 0.25        | 0.75  |
| L   | 0.50        | 0.90  |
| θ   | 0°          | 7°    |

RECOMMENDED  
SOLDERING FOOTPRINT\*

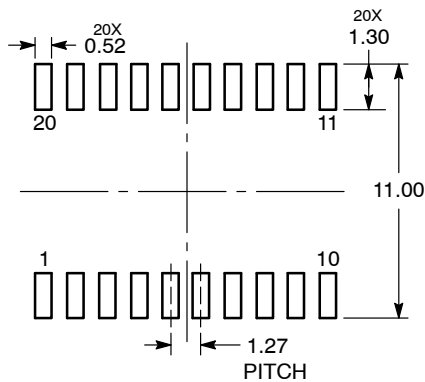

DIMENSIONS: MILLIMETERS

\*For additional information on our Pb-Free strategy and soldering details, please download the onsemi Soldering and Mounting Techniques Reference Manual, SOLDERRM/D.

GENERIC  
MARKING DIAGRAM\*

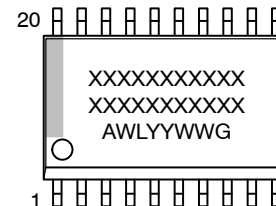

- XXXXXX = Specific Device Code
- A = Assembly Location
- WL = Wafer Lot
- YY = Year
- WW = Work Week
- G = Pb-Free Package

\*This information is generic. Please refer to device data sheet for actual part marking. Pb-Free indicator, "G" or microdot "▪", may or may not be present. Some products may not follow the Generic Marking.

|                  |             |   |
|------------------|-------------|---|
| DOCUMENT NUMBER: | 98ASB42343B | Electronic versions are uncontrolled except when accessed directly from the Document Repository.<br>Printed versions are uncontrolled except when stamped "CONTROLLED COPY" in red. |
| DESCRIPTION:     | SOIC-20 WB  | PAGE 1 OF 1   |

onsemi and onsemi are trademarks of Semiconductor Components Industries, LLC dba onsemi or its subsidiaries in the United States and/or other countries. onsemi reserves the right to make changes without further notice to any products herein. onsemi makes no warranty, representation or guarantee regarding the suitability of its products for any particular purpose, nor does onsemi assume any liability arising out of the application or use of any product or circuit, and specifically disclaims any and all liability, including without limitation special, consequential or incidental damages. onsemi does not convey any license under its patent rights nor the rights of others.

# MECHANICAL CASE OUTLINE

## PACKAGE DIMENSIONS

ON Semiconductor®

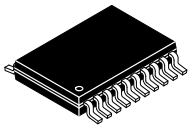

TSSOP-20 WB  
CASE 948E  
ISSUE D

DATE 17 FEB 2016

SCALE 2:1

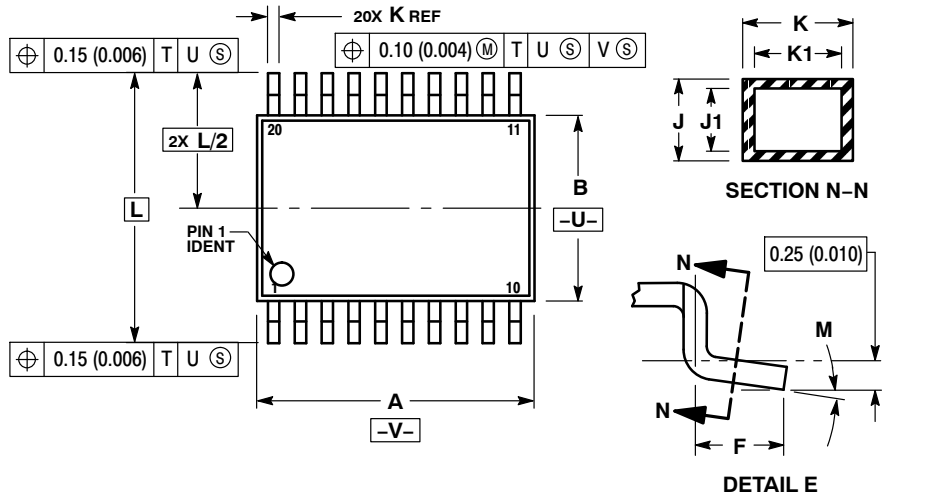

NOTES:

1. DIMENSIONING AND TOLERANCING PER ANSI Y14.5M, 1982.
2. CONTROLLING DIMENSION: MILLIMETER.
3. DIMENSION A DOES NOT INCLUDE MOLD FLASH, PROTRUSIONS OR GATE BURRS. MOLD FLASH OR GATE BURRS SHALL NOT EXCEED 0.15 (0.006) PER SIDE.
4. DIMENSION B DOES NOT INCLUDE INTERLEAD FLASH OR PROTRUSION. INTERLEAD FLASH OR PROTRUSION SHALL NOT EXCEED 0.25 (0.010) PER SIDE.
5. DIMENSION K DOES NOT INCLUDE DAMBAR PROTRUSION. ALLOWABLE DAMBAR PROTRUSION SHALL BE 0.08 (0.003) TOTAL IN EXCESS OF THE K DIMENSION AT MAXIMUM MATERIAL CONDITION.
6. TERMINAL NUMBERS ARE SHOWN FOR REFERENCE ONLY.
7. DIMENSION A AND B ARE TO BE DETERMINED AT DATUM PLANE -W-.

| DIM | MILLIMETERS |      | INCHES    |       |
|-----|-------------|------|-----------|-------|
|     | MIN         | MAX  | MIN       | MAX   |
| A   | 6.40        | 6.60 | 0.252     | 0.260 |
| B   | 4.30        | 4.50 | 0.169     | 0.177 |
| C   | ---         | 1.20 | ---       | 0.047 |
| D   | 0.05        | 0.15 | 0.002     | 0.006 |
| F   | 0.50        | 0.75 | 0.020     | 0.030 |
| G   | 0.65 BSC    |      | 0.026 BSC |       |
| H   | 0.27        | 0.37 | 0.011     | 0.015 |
| J   | 0.09        | 0.20 | 0.004     | 0.008 |
| J1  | 0.09        | 0.16 | 0.004     | 0.006 |
| K   | 0.19        | 0.30 | 0.007     | 0.012 |
| K1  | 0.19        | 0.25 | 0.007     | 0.010 |
| L   | 6.40 BSC    |      | 0.252 BSC |       |
| M   | 0°          | 8°   | 0°        | 8°    |

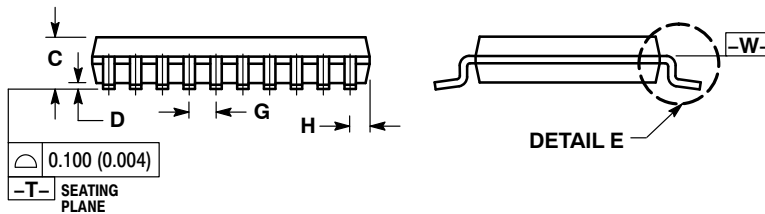

SOLDERING FOOTPRINT

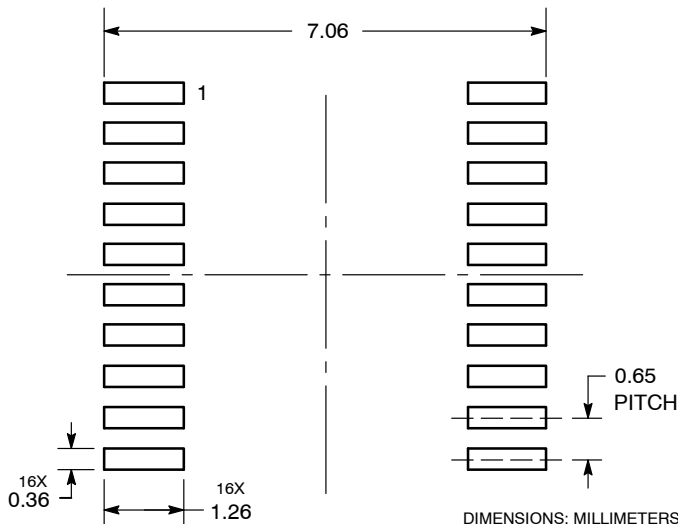

GENERIC MARKING DIAGRAM\*

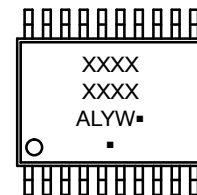

- A = Assembly Location
- L = Wafer Lot
- Y = Year
- W = Work Week
- = Pb-Free Package

(Note: Microdot may be in either location)

\*This information is generic. Please refer to device data sheet for actual part marking. Pb-Free indicator, "G" or microdot "▪", may or may not be present.

|                  |             |  |
|------------------|-------------|--|
| DOCUMENT NUMBER: | 98ASH70169A | Electronic versions are uncontrolled except when accessed directly from the Document Repository. Printed versions are uncontrolled except when stamped "CONTROLLED COPY" in red. |
| DESCRIPTION:     | TSSOP-20 WB | PAGE 1 OF 1  |

ON Semiconductor and ON are trademarks of Semiconductor Components Industries, LLC dba ON Semiconductor or its subsidiaries in the United States and/or other countries. ON Semiconductor reserves the right to make changes without further notice to any products herein. ON Semiconductor makes no warranty, representation or guarantee regarding the suitability of its products for any particular purpose, nor does ON Semiconductor assume any liability arising out of the application or use of any product or circuit, and specifically disclaims any and all liability, including without limitation special, consequential or incidental damages. ON Semiconductor does not convey any license under its patent rights nor the rights of others.

**onsemi**, **Onsemi**, and other names, marks, and brands are registered and/or common law trademarks of Semiconductor Components Industries, LLC dba "**onsemi**" or its affiliates and/or subsidiaries in the United States and/or other countries. **onsemi** owns the rights to a number of patents, trademarks, copyrights, trade secrets, and other intellectual property. A listing of **onsemi**'s product/patent coverage may be accessed at [www.onsemi.com/site/pdf/Patent-Marking.pdf](http://www.onsemi.com/site/pdf/Patent-Marking.pdf). **onsemi** reserves the right to make changes at any time to any products or information herein, without notice. The information herein is provided "as-is" and **onsemi** makes no warranty, representation or guarantee regarding the accuracy of the information, product features, availability, functionality, or suitability of its products for any particular purpose, nor does **onsemi** assume any liability arising out of the application or use of any product or circuit, and specifically disclaims any and all liability, including without limitation special, consequential or incidental damages. Buyer is responsible for its products and applications using **onsemi** products, including compliance with all laws, regulations and safety requirements or standards, regardless of any support or applications information provided by **onsemi**. "Typical" parameters which may be provided in **onsemi** data sheets and/or specifications can and do vary in different applications and actual performance may vary over time. All operating parameters, including "Typicals" must be validated for each customer application by customer's technical experts. **onsemi** does not convey any license under any of its intellectual property rights nor the rights of others. **onsemi** products are not designed, intended, or authorized for use as a critical component in life support systems or any FDA Class 3 medical devices or medical devices with a same or similar classification in a foreign jurisdiction or any devices intended for implantation in the human body. Should Buyer purchase or use **onsemi** products for any such unintended or unauthorized application, Buyer shall indemnify and hold **onsemi** and its officers, employees, subsidiaries, affiliates, and distributors harmless against all claims, costs, damages, and expenses, and reasonable attorney fees arising out of, directly or indirectly, any claim of personal injury or death associated with such unintended or unauthorized use, even if such claim alleges that **onsemi** was negligent regarding the design or manufacture of the part. **onsemi** is an Equal Opportunity/Affirmative Action Employer. This literature is subject to all applicable copyright laws and is not for resale in any manner.

## ADDITIONAL INFORMATION

### TECHNICAL PUBLICATIONS:

Technical Library: [www.onsemi.com/design/resources/technical-documentation](http://www.onsemi.com/design/resources/technical-documentation)  
onsemi Website: [www.onsemi.com](http://www.onsemi.com)

### ONLINE SUPPORT: [www.onsemi.com/support](http://www.onsemi.com/support)

For additional information, please contact your local Sales Representative at [www.onsemi.com/support/sales](http://www.onsemi.com/support/sales)