

MC74LCX16245

Low-Voltage CMOS 16-Bit Transceiver

With 5 V-Tolerant Inputs and Outputs (3-State, Non-Inverting)

The MC74LCX16245 is a high performance, non-inverting 16-bit transceiver operating from a 2.3 to 3.6 V supply. The device is byte controlled. Each byte has separate Output Enable inputs which can be tied together for full 16-bit operation. High impedance TTL compatible inputs significantly reduce current loading to input drivers while TTL compatible outputs offer improved switching noise performance. A V_I specification of 5.5 V allows MC74LCX16245 inputs to be safely driven from 5.0 V devices. The MC74LCX16245 is suitable for memory address driving and all TTL level bus oriented transceiver applications.

The 4.5 ns maximum propagation delays support high performance applications. Current drive capability is 24 mA at both A and B ports. The Transmit/Receive ($T/\bar{R}n$) inputs determine the direction of data flow through the bidirectional transceiver. Transmit (active-HIGH) enables data from A ports to B ports; Receive (active-LOW) enables data from B to A ports. The Output Enable inputs (\overline{OEn}), when HIGH, disable both A and B ports by placing them in a HIGH Z condition.

Features

- Designed for 2.3 to 3.6 V V_{CC} Operation
- 4.5 ns Maximum t_{pd}
- 5.0 V Tolerant – Interface Capability With 5.0 V TTL Logic
- Supports Live Insertion and Withdrawal
- I_{OFF} Specification Guarantees High Impedance When $V_{CC} = 0$ V
- LVTTTL Compatible
- LVCMOS Compatible
- 24 mA Balanced Output Sink and Source Capability
- Near Zero Static Supply Current in All Three Logic States (20 μ A) Substantially Reduces System Power Requirements
- Latchup Performance Exceeds 500 mA
- ESD Performance:
 - ◆ Human Body Model >2000 V
 - ◆ Machine Model >200 V
- These Devices are Pb-Free and are RoHS Compliant



ON Semiconductor®

<http://onsemi.com>

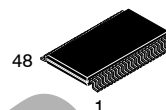

TSSOP-48
DT SUFFIX
CASE 1201

MARKING DIAGRAM

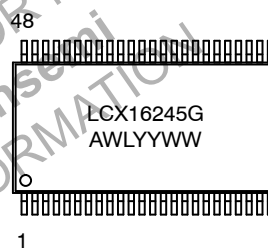

A = Assembly Location
WL = Wafer Lot
YY = Year
WW = Work Week
G = Pb-Free Package

ORDERING INFORMATION

See detailed ordering and shipping information in the package dimensions section on page 3 of this data sheet.

MC74LCX16245

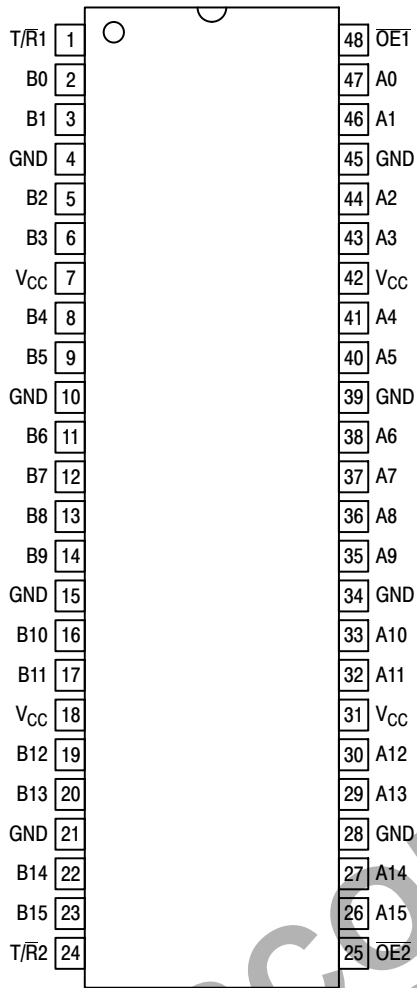

Figure 1. Pinout: 48-Lead (Top View)

Table 1. PIN NAMES

Pins	Function
$\overline{OE}n$	Output Enable Inputs
T/R _n	Transmit/Receive Inputs
A0 – A15	Side A Inputs or 3-State Outputs
B0 – B15	Side B Inputs or 3-State Outputs

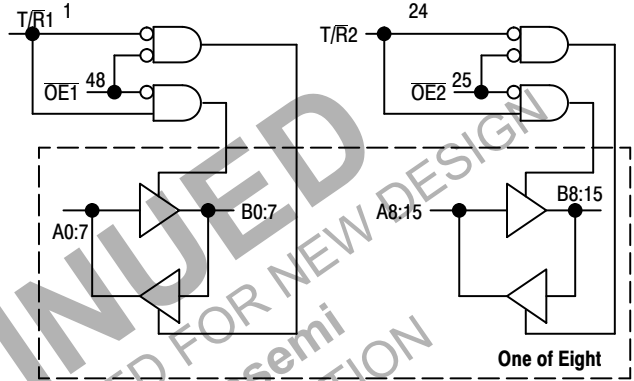

Figure 2. Logic Diagram

TRUTH TABLE

Inputs		Outputs	Inputs		Outputs
OE1	T/R1		OE2	T/R2	
L	L	Bus B0:7 Data to Bus A0:7	L	L	Bus B8:15 Data to Bus A8:15
L	H	Bus A0:7 Data to Bus B0:7	L	H	Bus A8:15 Data to Bus B8:15
H	X	High Z State on A0:7, B0:7	H	X	High Z State on A8:15, B8:15

H = High Voltage Level

L = Low Voltage Level

Z = High Impedance State

X = High or Low Voltage Level and Transitions Are Acceptable; for I_{CC} reasons, DO NOT FLOAT Inputs

MC74LCX16245

ORDERING INFORMATION

Device	Package	Shipping [†]
MC74LCX16245DTG	TSSOP-48*	39 Units / Rail
M74LCX16245DTR2G	TSSOP-48*	2500 / Tape & Reel

[†]For information on tape and reel specifications, including part orientation and tape sizes, please refer to our Tape and Reel Packaging Specifications Brochure, BRD8011/D.

*This package is inherently Pb-Free.

MAXIMUM RATINGS

Symbol	Parameter	Condition	Value	Units
V _{CC}	DC Supply Voltage		-0.5 to +7.0	V
V _I	DC Input Voltage		-0.5 ≤ V _I ≤ +7.0	V
V _O	DC Output Voltage	Output in 3-State	-0.5 ≤ V _O ≤ +7.0	V
		Output in HIGH or LOW State. (Note 1)	-0.5 ≤ V _O ≤ V _{CC} + 0.5	V
I _{IK}	DC Input Diode Current	V _I < GND	-50	mA
I _{OK}	DC Output Diode Current	V _O < GND	-50	mA
		V _O > V _{CC}	+50	mA
I _O	DC Output Source/Sink Current		±50	mA
I _{CC}	DC Supply Current Per Supply Pin		±100	mA
I _{GND}	DC Ground Current Per Ground Pin		±100	mA
T _{STG}	Storage Temperature Range		-65 to +150	°C

Maximum ratings are those values beyond which device damage can occur. Maximum ratings applied to the device are individual stress limit values (not normal operating conditions) and are not valid simultaneously. If these limits are exceeded, device functional operation is not implied, damage may occur and reliability may be affected.

1. I_O absolute maximum rating must be observed.

RECOMMENDED OPERATING CONDITIONS

Symbol	Parameter	Min	Typ	Max	Units
V _{CC}	Supply Voltage Operating Data Retention Only	2.0	2.5, 3.3	3.6	V
		1.5	2.5, 3.3	3.6	
V _I	Input Voltage	0		5.5	V
V _O	Output Voltage (HIGH or LOW State) (3-State)	0		V _{CC}	V
		0		5.5	
I _{OH}	HIGH Level Output Current V _{CC} = 3.0 V - 3.6 V V _{CC} = 2.7 V - 3.0 V V _{CC} = 2.3 V - 2.7 V			-24	mA
				-12	
				-8	
I _{OL}	LOW Level Output Current V _{CC} = 3.0 V - 3.6 V V _{CC} = 2.7 V - 3.0 V V _{CC} = 2.3 V - 2.7 V			+24	mA
				+12	
				+8	
T _A	Operating Free-Air Temperature	-40		+85	°C
Δt/ΔV	Input Transition Rise or Fall Rate, V _{IN} from 0.8 V to 2.0 V, V _{CC} = 3.0 V	0		10	ns/V

MC74LCX16245

DC ELECTRICAL CHARACTERISTICS

Symbol	Characteristic	Condition	T _A = -40°C to +85°C		Units
			Min	Max	
V _{IH}	HIGH Level Input Voltage (Note 2)	2.3 V ≤ V _{CC} ≤ 2.7 V	1.7		V
		2.7 V ≤ V _{CC} ≤ 3.6 V	2.0		
V _{IL}	LOW Level Input Voltage (Note 2)	2.3 V ≤ V _{CC} ≤ 2.7 V		0.7	V
		2.7 V ≤ V _{CC} ≤ 3.6 V		0.8	
V _{OH}	HIGH Level Output Voltage	2.3 V ≤ V _{CC} ≤ 3.6 V; I _{OL} = 100 μA	V _{CC} - 0.2		V
		V _{CC} = 2.3 V; I _{OH} = -8 mA	1.8		
		V _{CC} = 2.7 V; I _{OH} = -12 mA	2.2		
		V _{CC} = 3.0 V; I _{OH} = -18 mA	2.4		
		V _{CC} = 3.0 V; I _{OH} = -24 mA	2.2		
V _{OL}	LOW Level Output Voltage	2.3 V ≤ V _{CC} ≤ 3.6 V; I _{OL} = 100 μA		0.2	V
		V _{CC} = 2.3 V; I _{OL} = 8 mA		0.6	
		V _{CC} = 2.7 V; I _{OL} = 12 mA		0.4	
		V _{CC} = 3.0 V; I _{OL} = 16 mA		0.4	
		V _{CC} = 3.0 V; I _{OL} = 24 mA		0.55	
I _{OZ}	3-State Output Current	V _{CC} = 3.6 V, V _{IN} = V _{IH} or V _{IL} , V _{OUT} = 0 to 5.5 V		±5	μA
I _{OFF}	Power Off Leakage Current	V _{CC} = 0, V _{IN} = 5.5 V or V _{OUT} = 5.5 V		10	μA
I _{IN}	Input Leakage Current	V _{CC} = 3.6 V, V _{IN} = 5.5 V or GND		±5	μA
I _{CC}	Quiescent Supply Current	V _{CC} = 3.6 V, V _{IN} = 5.5 V or GND		10	μA
ΔI _{CC}	Increase in I _{CC} per Input	2.3 ≤ V _{CC} ≤ 3.6 V; V _{IH} = V _{CC} - 0.6 V		500	μA

2. These values of V_I are used to test DC electrical characteristics only.

AC CHARACTERISTICS (t_R = t_F = 2.5 ns; R_L = 500 Ω)

Symbol	Parameter	Waveform	T _A = -40°C to +85°C						Units
			V _{CC} = 3.3 V ± 0.3 V C _L = 50 pF		V _{CC} = 2.7 V C _L = 50 pF		V _{CC} = 2.5 V ± 0.2 V C _L = 30 pF		
			Min	Max	Min	Max	Min	Max	
t _{PLH} t _{PHL}	Propagation Delay Input to Output	1	1.5 1.5	4.5 4.5	1.5 1.5	5.2 5.2	1.5 1.5	5.4 5.4	ns
t _{PZH} t _{PZL}	Output Enable Time to High and Low Level	2	1.5 1.5	6.5 6.5	1.5 1.5	7.2 7.2	1.5 1.5	8.5 8.5	
t _{PHZ} t _{PLZ}	Output Disable Time From High and Low Level	2	1.5 1.5	6.4 6.4	1.5 1.5	6.9 6.9	1.5 1.5	7.7 7.7	ns
t _{OSSL} t _{OSLH}	Output-to-Output Skew (Note 3)			1.0 1.0					

3. Skew is defined as the absolute value of the difference between the actual propagation delay for any two separate outputs of the same device. The specification applies to any outputs switching in the same direction, either HIGH-to-LOW (t_{OSSL}) or LOW-to-HIGH (t_{OSLH}); parameter guaranteed by design.

MC74LCX16245

DYNAMIC SWITCHING CHARACTERISTICS

Symbol	Characteristic	Condition	T _A = +25°C			Units
			Min	Typ	Max	
V _{OLP}	Dynamic LOW Peak Voltage (Note 4)	V _{CC} = 3.3 V, C _L = 50 pF, V _{IH} = 3.3 V, V _{IL} = 0 V V _{CC} = 2.5 V, C _L = 30 pF, V _{IH} = 2.5 V, V _{IL} = 0 V		0.8 0.6		V V
V _{OLV}	Dynamic LOW Valley Voltage (Note 4)	V _{CC} = 3.3 V, C _L = 50 pF, V _{IH} = 3.3 V, V _{IL} = 0 V V _{CC} = 2.5 V, C _L = 30 pF, V _{IH} = 2.5 V, V _{IL} = 0 V		-0.8 -0.6		V V

4. Number of outputs defined as “n”. Measured with “n-1” outputs switching from HIGH-to-LOW or LOW-to-HIGH. The remaining output is measured in the LOW state.

CAPACITIVE CHARACTERISTICS

Symbol	Parameter	Condition	Typical	Units
C _{IN}	Input Capacitance	V _{CC} = 3.3 V, V _I = 0 V or V _{CC}	7	pF
C _{I/O}	Input/Output Capacitance	V _{CC} = 3.3 V, V _I = 0 V or V _{CC}	8	pF
C _{PD}	Power Dissipation Capacitance	10 MHz, V _{CC} = 3.3 V, V _I = 0 V or V _{CC}	20	pF

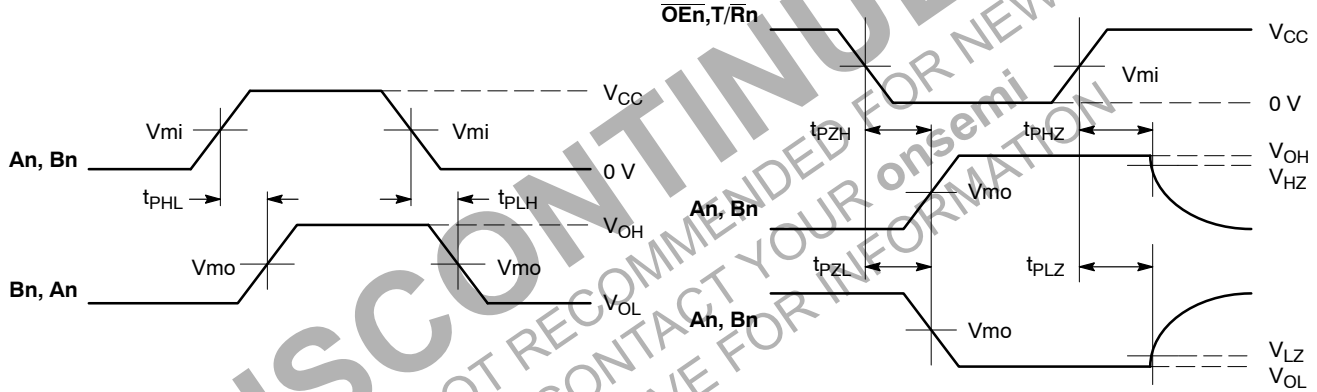

WAVEFORM 1 – PROPAGATION DELAYS
t_R = t_F = 2.5 ns, 10% to 90%, f = 1 MHz; t_w = 500 ns

WAVEFORM 2 – OUTPUT ENABLE AND DISABLE TIMES
t_R = t_F = 2.5 ns, 10% to 90%; f = 1 MHz; t_w = 500 ns

Figure 3. AC Waveforms

Table 2. AC WAVEFORMS

Symbol	V _{CC}		
	3.3 V ± 0.3 V	2.7 V	2.5 V ± 0.2 V
V _{mi}	1.5 V	1.5 V	V _{CC} / 2
V _{mo}	1.5 V	1.5 V	V _{CC} / 2
V _{HZ}	V _{OL} + 0.3 V	V _{OL} + 0.3 V	V _{OL} + 0.15 V
V _{LZ}	V _{OH} - 0.3 V	V _{OH} - 0.3 V	V _{OH} - 0.15 V

MC74LCX16245

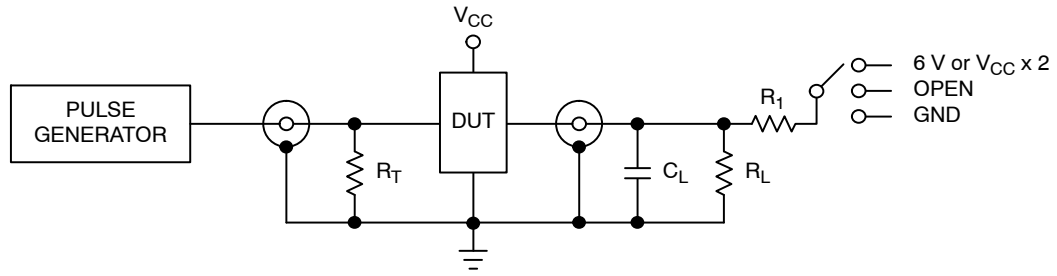

Figure 4. Test Circuit

Table 3. TEST CIRCUIT

Test	Switch
t_{PLH} , t_{PHL}	Open
t_{PZL} , t_{PLZ}	6 V at $V_{CC} = 3.3 \pm 0.3$ V 6 V at $V_{CC} = 2.5 \pm 0.2$ V
Open Collector/Drain t_{PLH} and t_{PHL}	6 V
t_{PZH} , t_{PHZ}	GND

$C_L = 50$ pF at $V_{CC} = 3.3 \pm 0.3$ V or equivalent (includes jig and probe capacitance)
 $C_L = 30$ pF at $V_{CC} = 2.5 \pm 0.2$ V or equivalent (includes jig and probe capacitance)
 $R_L = R_1 = 500 \Omega$ or equivalent
 $R_T = Z_{OUT}$ of pulse generator (typically 50Ω)

DISCONTINUED
 THIS DEVICE IS NOT RECOMMENDED FOR NEW DESIGN
 PLEASE CONTACT YOUR onsemi
 REPRESENTATIVE FOR INFORMATION

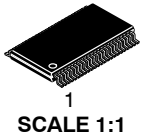

TSSOP-48
CASE 1201
ISSUE B

DATE 06 JUL 2010

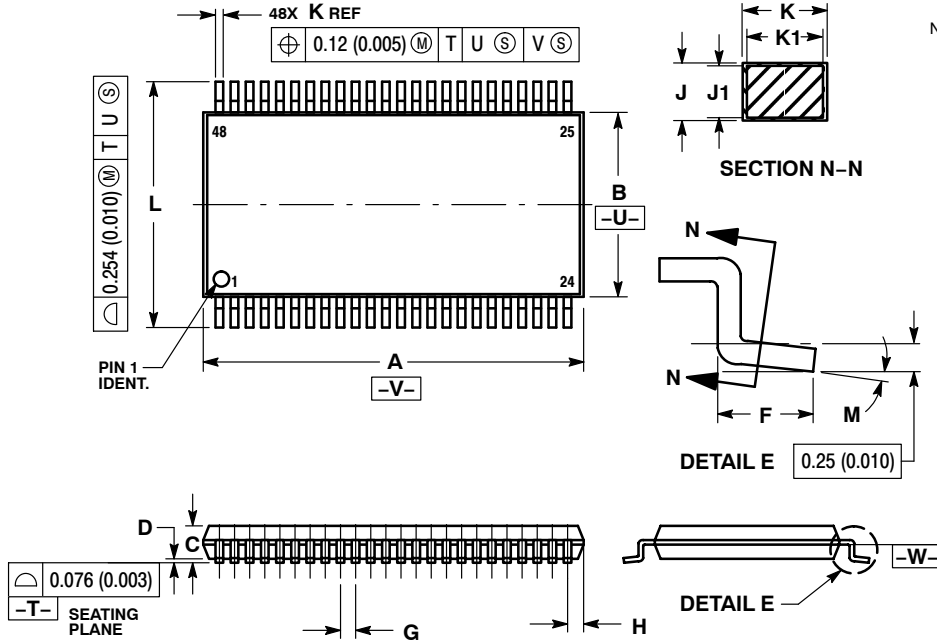

NOTES:

1. DIMENSIONING AND TOLERANCING PER ANSI Y14.5M, 1982.
2. CONTROLLING DIMENSION: MILLIMETER.
3. DIMENSIONS A AND B DO NOT INCLUDE MOLD FLASH, PROTRUSIONS OR GATE BURRS. MOLD FLASH OR GATE BURRS SHALL NOT EXCEED 0.15 (0.006) PER SIDE.
4. DIMENSION K DOES NOT INCLUDE DAMBAR PROTRUSION. ALLOWABLE DAMBAR PROTRUSION SHALL BE 0.08 (0.003) TOTAL IN EXCESS OF THE K DIMENSION AT MAXIMUM MATERIAL CONDITION.
5. TERMINAL NUMBERS ARE SHOWN FOR REFERENCE ONLY.
6. DIMENSIONS A AND B ARE TO BE DETERMINED AT DATUM PLANE -W-.

DIM	MILLIMETERS		INCHES	
	MIN	MAX	MIN	MAX
A	12.40	12.60	0.488	0.496
B	6.00	6.20	0.236	0.244
C	---	1.10	---	0.043
D	0.05	0.15	0.002	0.006
F	0.50	0.75	0.020	0.030
G	0.50 BSC		0.0197 BSC	
H	0.37	---	0.015	---
J	0.09	0.20	0.004	0.008
J1	0.09	0.16	0.004	0.006
K	0.17	0.27	0.007	0.011
K1	0.17	0.23	0.007	0.009
L	7.95	8.25	0.313	0.325
M	0°	8°	0°	8°

RECOMMENDED
SOLDERING FOOTPRINT*

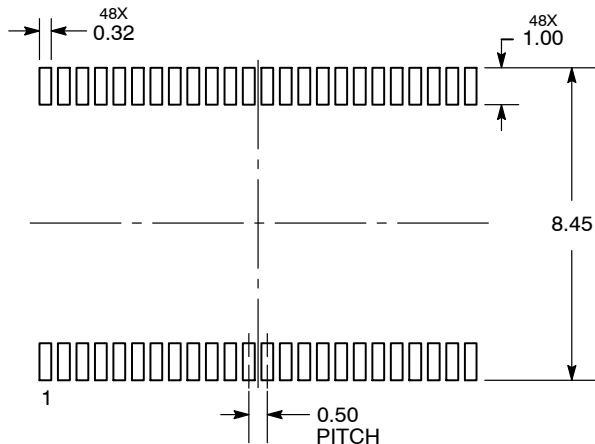

DIMENSIONS: MILLIMETERS

*For additional information on our Pb-Free strategy and soldering details, please download the onsemi Soldering and Mounting Techniques Reference Manual, SOLDERRM/D.

GENERIC
MARKING DIAGRAM*



- XXXXX = Specific Device Code
- A = Assembly Location
- WL = Wafer Lot
- YY = Year
- WW = Work Week
- G = Pb-Free Package

*This information is generic. Please refer to device data sheet for actual part marking. Pb-Free indicator, "G" or microdot "▪", may or may not be present. Some products may not follow the Generic Marking.

DOCUMENT NUMBER:	98ASH70297A	Electronic versions are uncontrolled except when accessed directly from the Document Repository. Printed versions are uncontrolled except when stamped "CONTROLLED COPY" in red.
DESCRIPTION:	TSSOP-48	PAGE 1 OF 1

onsemi and ONSEMI are trademarks of Semiconductor Components Industries, LLC dba onsemi or its subsidiaries in the United States and/or other countries. onsemi reserves the right to make changes without further notice to any products herein. onsemi makes no warranty, representation or guarantee regarding the suitability of its products for any particular purpose, nor does onsemi assume any liability arising out of the application or use of any product or circuit, and specifically disclaims any and all liability, including without limitation special, consequential or incidental damages. onsemi does not convey any license under its patent rights nor the rights of others.

onsemi, **Onsemi**, and other names, marks, and brands are registered and/or common law trademarks of Semiconductor Components Industries, LLC dba "**onsemi**" or its affiliates and/or subsidiaries in the United States and/or other countries. **onsemi** owns the rights to a number of patents, trademarks, copyrights, trade secrets, and other intellectual property. A listing of **onsemi**'s product/patent coverage may be accessed at www.onsemi.com/site/pdf/Patent-Marking.pdf. **onsemi** reserves the right to make changes at any time to any products or information herein, without notice. The information herein is provided "as-is" and **onsemi** makes no warranty, representation or guarantee regarding the accuracy of the information, product features, availability, functionality, or suitability of its products for any particular purpose, nor does **onsemi** assume any liability arising out of the application or use of any product or circuit, and specifically disclaims any and all liability, including without limitation special, consequential or incidental damages. Buyer is responsible for its products and applications using **onsemi** products, including compliance with all laws, regulations and safety requirements or standards, regardless of any support or applications information provided by **onsemi**. "Typical" parameters which may be provided in **onsemi** data sheets and/or specifications can and do vary in different applications and actual performance may vary over time. All operating parameters, including "Typicals" must be validated for each customer application by customer's technical experts. **onsemi** does not convey any license under any of its intellectual property rights nor the rights of others. **onsemi** products are not designed, intended, or authorized for use as a critical component in life support systems or any FDA Class 3 medical devices or medical devices with a same or similar classification in a foreign jurisdiction or any devices intended for implantation in the human body. Should Buyer purchase or use **onsemi** products for any such unintended or unauthorized application, Buyer shall indemnify and hold **onsemi** and its officers, employees, subsidiaries, affiliates, and distributors harmless against all claims, costs, damages, and expenses, and reasonable attorney fees arising out of, directly or indirectly, any claim of personal injury or death associated with such unintended or unauthorized use, even if such claim alleges that **onsemi** was negligent regarding the design or manufacture of the part. **onsemi** is an Equal Opportunity/Affirmative Action Employer. This literature is subject to all applicable copyright laws and is not for resale in any manner.

ADDITIONAL INFORMATION

TECHNICAL PUBLICATIONS:

Technical Library: www.onsemi.com/design/resources/technical-documentation
onsemi Website: www.onsemi.com

ONLINE SUPPORT: www.onsemi.com/support

For additional information, please contact your local Sales Representative at www.onsemi.com/support/sales