

# Octal D-Type Latch / 3-STATE Octal D-Type Flip-Flop

## MM74HCT573/MM74HCT574

### General Description

The MM74HCT573 octal D-type latches and MM74HCT574 octal D-type flip-flop advanced silicon-gate CMOS technology, which provides the inherent benefits of low power consumption and wide power supply range, but are LS-TTL input and output characteristic and pin-out compatible. The 3-STATE outputs are capable of driving 15 LS-TTL loads. All inputs are protected from damage due to static discharge by internal diodes to  $V_{CC}$  and ground.

When the MM74HCT573 Latch Enable input is HIGH, the Q outputs will follow the D inputs. When the Latch Enable goes LOW, data at the D inputs will be retained at the outputs until Latch Enable returns HIGH again. When a high logic level is applied to the Output Control input, all outputs go to a high impedance state, regardless of what signals are present at the other inputs and the state of the storage elements.

The MM74HCT574 are positive edge triggered flip-flops. Data at the D inputs, meeting the setup and hold time requirements, are transferred to the Q outputs on positive going transitions of the Clock (CK) input. When a high logic level is applied to the Output Control (OC) input, all outputs go to a high impedance state, regardless of what signals are present at the other inputs and the state of the storage elements.

The MM74HCT devices are intended to interface between TTL and NMOS components and standard CMOS devices. These parts are also plug in replacements for LS-TTL devices and can be used to reduce power consumption in existing designs.

### Features

- TTL Input Characteristic Compatible
- Typical Propagation Delay: 17 ns
- Low Input Current: 1  $\mu$ A Maximum
- Low Quiescent Current: 160  $\mu$ A Maximum
- Compatible with Bus-oriented Systems
- Output Drive Capability: 15 LS-TTL Loads
- These are Pb-Free Devices

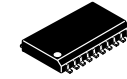

SOIC-20 WB  
CASE 751D-05

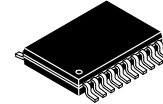

TSSOP20, 4.4x6.5  
CASE 948AQ

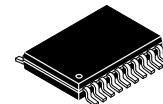

TSSOP-20 WB  
CASE 948E

### MARKING DIAGRAMS

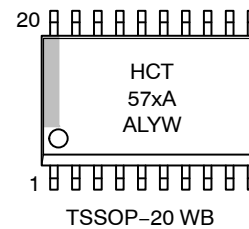
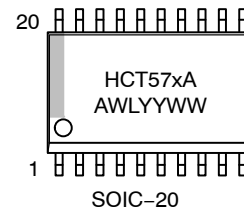

HCT57xA = Specific Device Code  
x = 3 or 4  
A = Assembly Location  
WL, L = Wafer Lot  
YY, Y = Year  
WW, W = Work Week

### ORDERING INFORMATION

See detailed ordering and shipping information on page 7 of this data sheet.

# MM74HCT573/MM74HCT574

## Connection Diagrams

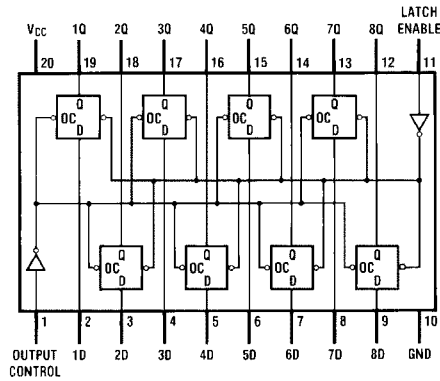

MM74HCT573  
(Top View)

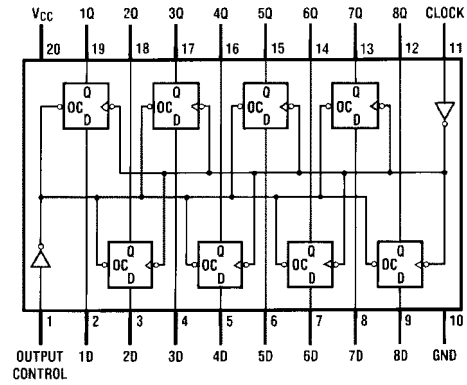

MM74HCT574  
(Top View)

Figure 1. Pin Assignments for SOIC and TSSOP

## Truth Tables

### MM74HCT573

Output Control	LE	Data	373 Output
L	H	H	H
L	H	L	L
L	L	X	Q <sub>0</sub>
H	X	X	Z

NOTES: H = HIGH Level  
 L = LOW Level  
 Q<sub>0</sub> = Level of output before steady-state input conditions were established.  
 Z = High Impedance State

### MM74HCT574

Output Control	Clock	Data	374 Output
L	↑	H	H
L	↑	L	L
L	L	X	Q <sub>0</sub>
H	X	X	Z

NOTES: H = HIGH Level  
 L = LOW Level  
 Q<sub>0</sub> = The level of the output before steady state input conditions were established.  
 X = Don't Care  
 Z = High Impedance State  
 ↑ = Transition from LOW-to-HIGH

# MM74HCT573/MM74HCT574

## ABSOLUTE MAXIMUM RATINGS (Note 1)

Symbol	Parameter		Rating
$V_{CC}$	Supply Voltage		-0.5 to +7.0 V
$V_{IN}$	DC Input Voltage		-0.5 to $V_{CC} + 0.5$ V
$V_{OUT}$	DC Output Voltage		-0.5 to $V_{CC} + 0.5$ V
$I_{IK}, I_{OK}$	Clamp Diode Current		$\pm 20$ mA
$I_{OUT}$	DC Output Current, per Pin		$\pm 35$ mA
$I_{CC}$	DC $V_{CC}$ or GND Current, per Pin		$\pm 70$ mA
$T_{STG}$	Storage Temperature Range		-65°C to +150°C
$P_D$	Power Dissipation	S.O. Package only	500 mW
$T_L$	Lead Temperature (Soldering 10 Seconds)		260°C

Stresses exceeding those listed in the Maximum Ratings table may damage the device. If any of these limits are exceeded, device functionality should not be assumed, damage may occur and reliability may be affected.

1. Unless otherwise specified all voltages are referenced to ground.

## RECOMMENDED OPERATING CONDITIONS

Symbol	Parameter	Min	Max	Unit
$V_{CC}$	Supply Voltage	4.5	5.5	V
$V_{IN}, V_{OUT}$	DC Input or Output Voltage	0	$V_{CC}$	V
$T_A$	Operating Temperature Range	-55	+125	°C
$t_r, t_f$	Input Rise or Fall Times		500	ns

Functional operation above the stresses listed in the Recommended Operating Ranges is not implied. Extended exposure to stresses beyond the Recommended Operating Ranges limits may affect device reliability.

## MM74HCT573/MM74HCT574

### DC ELECTRICAL CHARACTERISTICS ( $V_{CC} = 5\text{ V} \pm 10\%$ , unless otherwise specified)

Symbol	Parameter	Conditions	T <sub>A</sub> = 25°C		T <sub>A</sub> = -40°C to 85°C	T <sub>A</sub> = -55°C to 125°C	Unit
			Typ	Guaranteed Limits			
V <sub>IH</sub>	Minimum HIGH Level Input Voltage		-	2.0	2.0	2.0	V
V <sub>IL</sub>	Maximum LOW Level Input Voltage		-	0.8	0.8	0.8	V
V <sub>OH</sub>	Minimum HIGH Level Output Voltage	V <sub>IN</sub> = V <sub>IH</sub> or V <sub>IL</sub>  I <sub>OUT</sub>   = 20 μA	V <sub>CC</sub>	V <sub>CC</sub> - 0.1	V <sub>CC</sub> - 0.1	V <sub>CC</sub> - 0.1	V
		V <sub>IN</sub> = V <sub>IH</sub> or V <sub>IL</sub>  I <sub>OUT</sub>   = 6.0 mA, V <sub>CC</sub> = 4.5 V	4.2	3.98	3.84	3.7	V
		V <sub>IN</sub> = V <sub>IH</sub> or V <sub>IL</sub>  I <sub>OUT</sub>   = 7.2 mA, V <sub>CC</sub> = 5.5 V	5.7	4.98	4.84	4.7	V
V <sub>OL</sub>	Maximum LOW Level Voltage	V <sub>IN</sub> = V <sub>IH</sub> or V <sub>IL</sub>  I <sub>OUT</sub>   = 20 μA	0	0.1	0.1	0.1	V
		V <sub>IN</sub> = V <sub>IH</sub> or V <sub>IL</sub>  I <sub>OUT</sub>   = 6.0 mA, V <sub>CC</sub> = 4.5 V	0.2	0.26	0.33	0.4	V
		V <sub>IN</sub> = V <sub>IH</sub> or V <sub>IL</sub>  I <sub>OUT</sub>   = 7.2 mA, V <sub>CC</sub> = 5.5 V	0.2	0.26	0.33	0.4	V
I <sub>IN</sub>	Maximum Input Current	V <sub>IN</sub> = V <sub>CC</sub> or GND, V <sub>IH</sub> or V <sub>IL</sub>	-	±0.1	±1.0	±1.0	μA
I <sub>OZ</sub>	Maximum 3-STATE Output Leakage Current	V <sub>OUT</sub> = V <sub>CC</sub> or GND, Enable = V <sub>IH</sub> or V <sub>IL</sub>	-	±0.5	±5.0	±10	μA
I <sub>CC</sub>	Maximum Quiescent Supply Current	V <sub>IN</sub> = V <sub>CC</sub> or GND, I <sub>OUT</sub> = 0 μA	-	8.0	80	160	μA
		V <sub>IN</sub> = 2.4 V or 0.5 V (Note 2)	-	1.5	1.8	2.0	mA

Product parametric performance is indicated in the Electrical Characteristics for the listed test conditions, unless otherwise noted. Product performance may not be indicated by the Electrical Characteristics if operated under different conditions.

2. Measured per pin. All others tied to V<sub>CC</sub> or ground.

# MM74HCT573/MM74HCT574

## AC ELECTRICAL CHARACTERISTICS

(MM74HCT573:  $V_{CC} = 5.0\text{ V}$ ,  $T_A = 25^\circ\text{C}$ ,  $t_r = t_f = 6\text{ ns}$ , unless otherwise specified)

Symbol	Parameter	Conditions	Typ	Guaranteed Limit	Unit
$t_{PHL}$ , $t_{PLH}$	Maximum Propagation Delay Data to Output	$C_L = 45\text{ pF}$	17	27	ns
$t_{PHL}$ , $t_{PLH}$	Maximum Propagation Delay Latch Enable to Output	$C_L = 45\text{ pF}$	16	27	ns
$t_{PZH}$ , $t_{PZL}$	Maximum Enable Propagation Delay Control to Output	$C_L = 45\text{ pF}$ $R_L = 1\text{ k}\Omega$	21	30	ns
$t_{PHZ}$ , $t_{PLZ}$	Maximum Disable Propagation Delay Control to Output	$C_L = 5\text{ pF}$ $R_L = 1\text{ k}\Omega$	14	23	ns
$t_W$	Minimum Clock Pulse Width		-	15	ns
$t_S$	Minimum Setup Time Data to Clock		-	5	ns
$t_H$	Minimum Hold Time Clock to Data		-	12	ns

Product parametric performance is indicated in the Electrical Characteristics for the listed test conditions, unless otherwise noted. Product performance may not be indicated by the Electrical Characteristics if operated under different conditions.

## AC ELECTRICAL CHARACTERISTICS

(MM74HCT573:  $V_{CC} = 5.0\text{ V} \pm 10\%$ ,  $t_r = t_f = 6\text{ ns}$ , unless otherwise specified)

Symbol	Parameter	Conditions	$T_A = 25^\circ\text{C}$		$T_A = -40^\circ\text{C}$ to $85^\circ\text{C}$	$T_A = -55^\circ\text{C}$ to $125^\circ\text{C}$	Unit
			Typ	Guaranteed Limits			
$t_{PHL}$ , $t_{PLH}$	Maximum Propagation Delay Data to Output	$C_L = 50\text{ pF}$	18	30	38	45	ns
$t_{PHL}$ , $t_{PLH}$	Maximum Propagation Delay Latch Enable to Output	$C_L = 50\text{ pF}$	17	30	44	53	ns
$t_{PZH}$ , $t_{PZL}$	Maximum Enable Propagation Delay Control to Output	$C_L = 50\text{ pF}$ $R_L = 1\text{ k}\Omega$	22	30	38	45	ns
$t_{PHZ}$ , $t_{PLZ}$	Maximum Disable Propagation Delay Control to Output	$C_L = 50\text{ pF}$ $R_L = 1\text{ k}\Omega$	15	30	38	45	ns
$t_{THL}$ , $t_{TLH}$	Maximum Output Rise and Fall Time	$C_L = 50\text{ pF}$	6	12	15	18	ns
$t_W$	Minimum Clock Pulse Width		-	15	20	24	ns
$t_S$	Minimum Setup Time Data to Clock		3	5	6	8	ns
$t_H$	Minimum Hold Time Clock to Data		4	12	15	18	ns
$C_{IN}$	Maximum Input Capacitance		-	10	10	10	pF
$C_{OUT}$	Maximum Output Capacitance		-	20	20	20	pF
$C_{PD}$	Power Dissipation Capacitance (Note 3)	$OC = V_{CC}$	-	5	-	-	pF
		$OC = GND$	-	52	-	-	pF

Product parametric performance is indicated in the Electrical Characteristics for the listed test conditions, unless otherwise noted. Product performance may not be indicated by the Electrical Characteristics if operated under different conditions.

3.  $C_{PD}$  determines the no load dynamic power consumption,  $P_D = C_{PD} V_{CC}^2 f + I_{CC} V_{CC}$ , and the no load dynamic current consumption,  $I_S = C_{PD} V_{CC}^2 f + I_{CC}$ .

## MM74HCT573/MM74HCT574

### AC ELECTRICAL CHARACTERISTICS

(MM74HCT574:  $V_{CC} = 5.0\text{ V}$ ,  $T_A = 25^\circ\text{C}$ ,  $t_r = t_f = 6\text{ ns}$ )

Symbol	Parameter	Conditions	Typ	Guaranteed Limit	Unit
$f_{MAX}$	Maximum Clock Frequency		60	33	MHz
$t_{PHL}$ , $t_{PLH}$	Maximum Propagation Delay to Output	$C_L = 45\text{ pF}$	17	27	ns
$t_{PZH}$ , $t_{PZL}$	Maximum Enable Propagation Delay Control to Output	$C_L = 45\text{ pF}$ $R_L = 1\text{ k}\Omega$	19	28	ns
$t_{PHZ}$ , $t_{PLZ}$	Maximum Disable Propagation Delay Control to Output	$C_L = 45\text{ pF}$ $R_L = 1\text{ k}\Omega$	14	25	ns
$t_W$	Minimum Clock Pulse Width		-	15	ns
$t_S$	Minimum Setup Time Data to Clock		-	12	ns
$t_H$	Minimum Hold Time Clock to Data		-	5	ns

Product parametric performance is indicated in the Electrical Characteristics for the listed test conditions, unless otherwise noted. Product performance may not be indicated by the Electrical Characteristics if operated under different conditions.

### AC ELECTRICAL CHARACTERISTICS

(MM74HCT574:  $V_{CC} = 5.0\text{ V} \pm 10\%$ ,  $t_r = t_f = 6\text{ ns}$ , unless otherwise specified)

Symbol	Parameter	Conditions	$T_A = 25^\circ\text{C}$		$T_A = -40^\circ\text{C}$ to $85^\circ\text{C}$	$T_A = -55^\circ\text{C}$ to $125^\circ\text{C}$	Unit
			Typ	Guaranteed Limits			
$f_{MAX}$	Maximum Clock Frequency		-	33	28	23	MHz
$t_{PHL}$ , $t_{PLH}$	Maximum Propagation Delay Clock to Output	$C_L = 50\text{ pF}$	18	30	38	45	ns
$t_{PZH}$ , $t_{PZL}$	Maximum Enable Propagation Delay Control to Output	$C_L = 50\text{ pF}$ $R_L = 1\text{ k}\Omega$	22	30	38	45	ns
$t_{PHZ}$ , $t_{PLZ}$	Maximum Disable Propagation Delay Control to Output	$C_L = 50\text{ pF}$ $R_L = 1\text{ k}\Omega$	15	30	38	45	ns
$t_{THL}$ , $t_{TLH}$	Maximum Output Rise and Fall Time	$C_L = 50\text{ pF}$	6	12	15	18	ns
$t_W$	Minimum Clock Pulse Width		-	15	20	24	ns
$t_S$	Minimum Setup Time Data to Clock		6	12	15	18	ns
$t_H$	Minimum Hold Time Clock to Data		1	5	6	8	ns
$C_{IN}$	Maximum Input Capacitance		-	10	10	10	pF
$C_{OUT}$	Maximum Output Capacitance		-	20	20	20	pF
$C_{PD}$	Power Dissipation Capacitance (Note 4)	$OC = V_{CC}$	5	-	-	-	pF
		$OC = GND$	58	-	-	-	pF

Product parametric performance is indicated in the Electrical Characteristics for the listed test conditions, unless otherwise noted. Product performance may not be indicated by the Electrical Characteristics if operated under different conditions.

4.  $C_{PD}$  determines the no load dynamic power consumption,  $P_D = C_{PD} V_{CC}^2 f + I_{CC} V_{CC}$ , and the no load dynamic current consumption,  $I_S = C_{PD} V_{CC}^2 f + I_{CC}$ .

## MM74HCT573/MM74HCT574

### ORDERING INFORMATION

Part Number	Package	Shipping <sup>†</sup>
MM74HCT573WMX	SOIC-20 WB, Case 751D-05 (Pb-Free and Halide-Free)	1000 Units / Tape & Reel
MM74HCT573MTC	TSSOP-20 WB, Case 948E (Pb-Free)	75 Units / Tube
MM74HCT573MTCX		2500 Units / Tape & Reel
MM74HCT574WM	SOIC-20 WB, Case 751D-05 (Pb-Free and Halide-Free)	38 Units / Tube
MM74HCT574WMX		1000 Units / Tape & Reel
MM74HCT574MTC	TSSOP-20 WB, Case 948E (Pb-Free)	75 Units / Tube
MM74HCT574MTCX	TSSOP20, Case 948AQ-01 (Pb-Free)	2500 Units / Tape & Reel

<sup>†</sup>For information on tape and reel specifications, including part orientation and tape sizes, please refer to our Tape and Reel Packaging Specifications Brochure, [BRD8011/D](#).

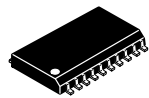

SCALE 1:1

SOIC-20 WB  
CASE 751D-05  
ISSUE H

DATE 22 APR 2015

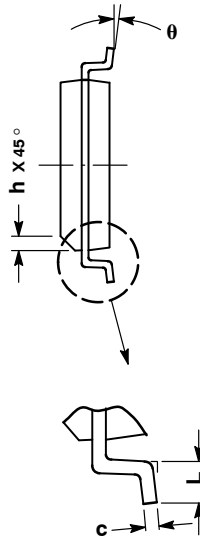
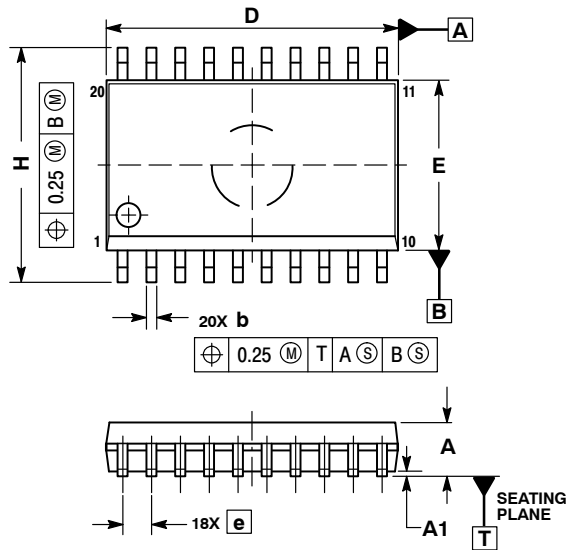

NOTES:

1. DIMENSIONS ARE IN MILLIMETERS.
2. INTERPRET DIMENSIONS AND TOLERANCES PER ASME Y14.5M, 1994.
3. DIMENSIONS D AND E DO NOT INCLUDE MOLD PROTRUSION.
4. MAXIMUM MOLD PROTRUSION 0.15 PER SIDE.
5. DIMENSION B DOES NOT INCLUDE DAMBAR PROTRUSION. ALLOWABLE PROTRUSION SHALL BE 0.13 TOTAL IN EXCESS OF B DIMENSION AT MAXIMUM MATERIAL CONDITION.

DIM	MILLIMETERS	
	MIN	MAX
A	2.35	2.65
A1	0.10	0.25
b	0.35	0.49
c	0.23	0.32
D	12.65	12.95
E	7.40	7.60
e	1.27 BSC	
H	10.05	10.55
h	0.25	0.75
L	0.50	0.90
θ	0°	7°

RECOMMENDED  
SOLDERING FOOTPRINT\*

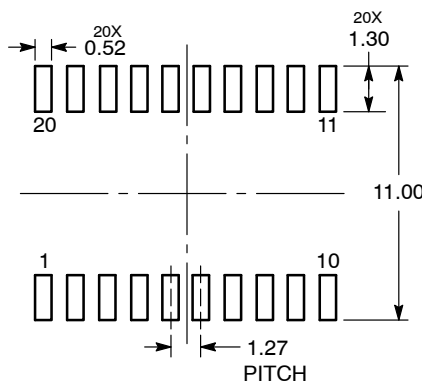

DIMENSIONS: MILLIMETERS

\*For additional information on our Pb-Free strategy and soldering details, please download the onsemi Soldering and Mounting Techniques Reference Manual, SOLDERRM/D.

GENERIC  
MARKING DIAGRAM\*

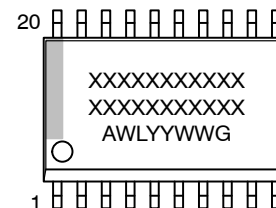

- XXXXXX = Specific Device Code
- A = Assembly Location
- WL = Wafer Lot
- YY = Year
- WW = Work Week
- G = Pb-Free Package

\*This information is generic. Please refer to device data sheet for actual part marking. Pb-Free indicator, "G" or microdot "▪", may or may not be present. Some products may not follow the Generic Marking.

DOCUMENT NUMBER:	98ASB42343B	Electronic versions are uncontrolled except when accessed directly from the Document Repository. Printed versions are uncontrolled except when stamped "CONTROLLED COPY" in red.
DESCRIPTION:	SOIC-20 WB	PAGE 1 OF 1

onsemi and onsemi are trademarks of Semiconductor Components Industries, LLC dba onsemi or its subsidiaries in the United States and/or other countries. onsemi reserves the right to make changes without further notice to any products herein. onsemi makes no warranty, representation or guarantee regarding the suitability of its products for any particular purpose, nor does onsemi assume any liability arising out of the application or use of any product or circuit, and specifically disclaims any and all liability, including without limitation special, consequential or incidental damages. onsemi does not convey any license under its patent rights nor the rights of others.



# MECHANICAL CASE OUTLINE

## PACKAGE DIMENSIONS

ON Semiconductor®



TSSOP-20 WB  
CASE 948E  
ISSUE D

DATE 17 FEB 2016

SCALE 2:1



NOTES:

1. DIMENSIONING AND TOLERANCING PER ANSI Y14.5M, 1982.
2. CONTROLLING DIMENSION: MILLIMETER.
3. DIMENSION A DOES NOT INCLUDE MOLD FLASH, PROTRUSIONS OR GATE BURRS. MOLD FLASH OR GATE BURRS SHALL NOT EXCEED 0.15 (0.006) PER SIDE.
4. DIMENSION B DOES NOT INCLUDE INTERLEAD FLASH OR PROTRUSION. INTERLEAD FLASH OR PROTRUSION SHALL NOT EXCEED 0.25 (0.010) PER SIDE.
5. DIMENSION K DOES NOT INCLUDE DAMBAR PROTRUSION. ALLOWABLE DAMBAR PROTRUSION SHALL BE 0.08 (0.003) TOTAL IN EXCESS OF THE K DIMENSION AT MAXIMUM MATERIAL CONDITION.
6. TERMINAL NUMBERS ARE SHOWN FOR REFERENCE ONLY.
7. DIMENSION A AND B ARE TO BE DETERMINED AT DATUM PLANE -W-.

DIM	MILLIMETERS		INCHES	
	MIN	MAX	MIN	MAX
A	6.40	6.60	0.252	0.260
B	4.30	4.50	0.169	0.177
C	---	1.20	---	0.047
D	0.05	0.15	0.002	0.006
F	0.50	0.75	0.020	0.030
G	0.65 BSC		0.026 BSC	
H	0.27	0.37	0.011	0.015
J	0.09	0.20	0.004	0.008
J1	0.09	0.16	0.004	0.006
K	0.19	0.30	0.007	0.012
K1	0.19	0.25	0.007	0.010
L	6.40 BSC		0.252 BSC	
M	0°	8°	0°	8°



SOLDERING FOOTPRINT



GENERIC MARKING DIAGRAM\*



- A = Assembly Location
- L = Wafer Lot
- Y = Year
- W = Work Week
- = Pb-Free Package

(Note: Microdot may be in either location)

\*This information is generic. Please refer to device data sheet for actual part marking. Pb-Free indicator, "G" or microdot "▪", may or may not be present.

DOCUMENT NUMBER:	98ASH70169A	Electronic versions are uncontrolled except when accessed directly from the Document Repository. Printed versions are uncontrolled except when stamped "CONTROLLED COPY" in red.
DESCRIPTION:	TSSOP-20 WB	PAGE 1 OF 1

ON Semiconductor and ON are trademarks of Semiconductor Components Industries, LLC dba ON Semiconductor or its subsidiaries in the United States and/or other countries. ON Semiconductor reserves the right to make changes without further notice to any products herein. ON Semiconductor makes no warranty, representation or guarantee regarding the suitability of its products for any particular purpose, nor does ON Semiconductor assume any liability arising out of the application or use of any product or circuit, and specifically disclaims any and all liability, including without limitation special, consequential or incidental damages. ON Semiconductor does not convey any license under its patent rights nor the rights of others.

**MECHANICAL CASE OUTLINE**  
**PACKAGE DIMENSIONS**



**TSSOP20, 4.4x6.5**  
**CASE 948AQ**  
**ISSUE A**

DATE 19 MAR 2009

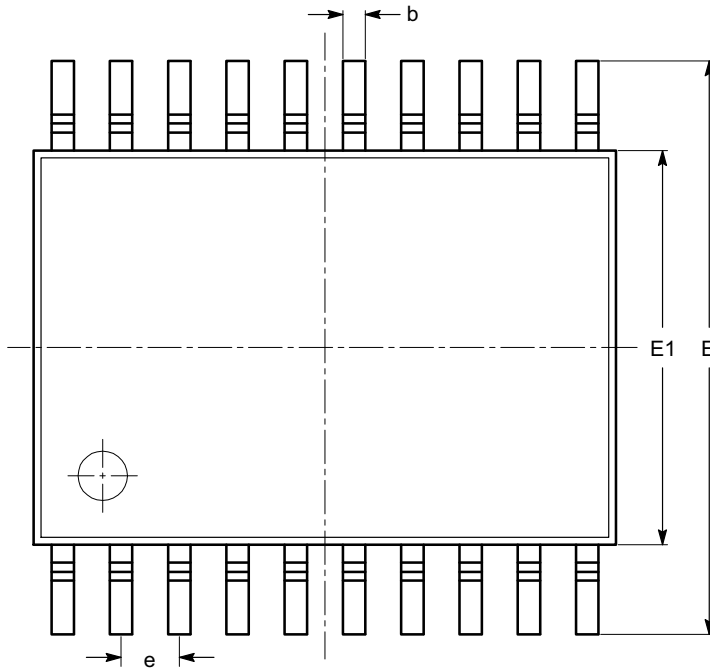

SYMBOL	MIN	NOM	MAX
A			1.20
A1	0.05		0.15
A2	0.80		1.05
b	0.19		0.30
c	0.09		0.20
D	6.40	6.50	6.60
E	6.30	6.40	6.50
E1	4.30	4.40	4.50
e	0.65 BSC		
L	0.45	0.60	0.75
L1	1.00 REF		
$\theta$	0°		8°

TOP VIEW

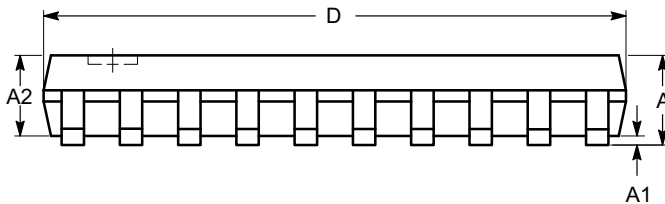

SIDE VIEW

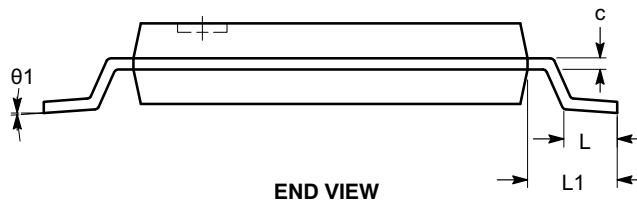

END VIEW

**Notes:**

- (1) All dimensions are in millimeters. Angles in degrees.
- (2) Complies with JEDEC MO-153.

<b>DOCUMENT NUMBER:</b>	<b>98AON34453E</b>	Electronic versions are uncontrolled except when accessed directly from the Document Repository. Printed versions are uncontrolled except when stamped "CONTROLLED COPY" in red.
<b>DESCRIPTION:</b>	<b>TSSOP20, 4.4X6.5</b>	<b>PAGE 1 OF 1</b>

onsemi and ONSEMI are trademarks of Semiconductor Components Industries, LLC dba onsemi or its subsidiaries in the United States and/or other countries. onsemi reserves the right to make changes without further notice to any products herein. onsemi makes no warranty, representation or guarantee regarding the suitability of its products for any particular purpose, nor does onsemi assume any liability arising out of the application or use of any product or circuit, and specifically disclaims any and all liability, including without limitation special, consequential or incidental damages. onsemi does not convey any license under its patent rights nor the rights of others.

**onsemi**, **Onsemi**, and other names, marks, and brands are registered and/or common law trademarks of Semiconductor Components Industries, LLC dba "**onsemi**" or its affiliates and/or subsidiaries in the United States and/or other countries. **onsemi** owns the rights to a number of patents, trademarks, copyrights, trade secrets, and other intellectual property. A listing of **onsemi**'s product/patent coverage may be accessed at [www.onsemi.com/site/pdf/Patent-Marking.pdf](http://www.onsemi.com/site/pdf/Patent-Marking.pdf). **onsemi** reserves the right to make changes at any time to any products or information herein, without notice. The information herein is provided "as-is" and **onsemi** makes no warranty, representation or guarantee regarding the accuracy of the information, product features, availability, functionality, or suitability of its products for any particular purpose, nor does **onsemi** assume any liability arising out of the application or use of any product or circuit, and specifically disclaims any and all liability, including without limitation special, consequential or incidental damages. Buyer is responsible for its products and applications using **onsemi** products, including compliance with all laws, regulations and safety requirements or standards, regardless of any support or applications information provided by **onsemi**. "Typical" parameters which may be provided in **onsemi** data sheets and/or specifications can and do vary in different applications and actual performance may vary over time. All operating parameters, including "Typicals" must be validated for each customer application by customer's technical experts. **onsemi** does not convey any license under any of its intellectual property rights nor the rights of others. **onsemi** products are not designed, intended, or authorized for use as a critical component in life support systems or any FDA Class 3 medical devices or medical devices with a same or similar classification in a foreign jurisdiction or any devices intended for implantation in the human body. Should Buyer purchase or use **onsemi** products for any such unintended or unauthorized application, Buyer shall indemnify and hold **onsemi** and its officers, employees, subsidiaries, affiliates, and distributors harmless against all claims, costs, damages, and expenses, and reasonable attorney fees arising out of, directly or indirectly, any claim of personal injury or death associated with such unintended or unauthorized use, even if such claim alleges that **onsemi** was negligent regarding the design or manufacture of the part. **onsemi** is an Equal Opportunity/Affirmative Action Employer. This literature is subject to all applicable copyright laws and is not for resale in any manner.

## ADDITIONAL INFORMATION

### TECHNICAL PUBLICATIONS:

Technical Library: [www.onsemi.com/design/resources/technical-documentation](http://www.onsemi.com/design/resources/technical-documentation)  
onsemi Website: [www.onsemi.com](http://www.onsemi.com)

### ONLINE SUPPORT: [www.onsemi.com/support](http://www.onsemi.com/support)

For additional information, please contact your local Sales Representative at [www.onsemi.com/support/sales](http://www.onsemi.com/support/sales)