

Linear Regulator - Low Output Voltage, Ultra-Fast Low Dropout, Enable

3.0 A

NCP5663, NCV5663

The NCP5663/NCV5663 is a high performance, low dropout linear regulator designed for high power applications that require up to 3.0 A current. It is offered in both fixed and adjustable output versions. With output voltages as low as 0.9 V and ultra-fast response times for load transients, the NCP5663/NCV5663 also provides additional features such as Enable and Error Flag (for the fixed output version), increasing the utility of this device. A thermally robust, 5 pin D²PAK, combined with an architecture that offers low ground current (independent of load), provides for a superior high-current LDO solution.

Features

- Ultra-Fast Transient Response (Settling Time: 1–3 μs)
- Low Noise Without Bypass Capacitor (28 μV_{rms})
- Low Ground Current Independent of Load (3.0 mA Maximum)
- Fixed/Adjustable Output Voltage Versions
- Enable Function
- Error Flag (Fixed Output Version)
- Current Limit Protection
- Thermal Protection
- 0.9 V Reference Voltage for Ultra-Low Output Operation
- Power Supply Rejection Ratio > 65 dB
- NCV Prefix for Automotive and Other Applications Requiring Unique Site and Control Change Requirements; AEC-Q100 Qualified and PPAP Capable
- This is a Pb-Free Device

Applications

- Servers
- ASIC Power Supplies
- Post Regulation for Power Supplies
- Constant Current Source
- Networking Equipment
- Gaming and STB Modules

MARKING DIAGRAM

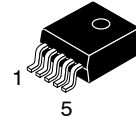

D²PAK
CASE 936A

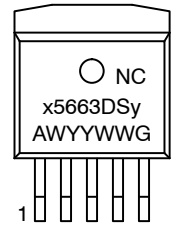

- Tab = Ground
 Pin 1. Enable
 2. V_{in}
 3. Ground
 4. V_{out}
 5. Adj (adjustable output)
 5. Error Flag (fixed output)

- x = P or V
 y = A for Adjustable Version
 B for Fixed 1.5 V Version
 C for Fixed 1.8 V Version
 A = Assembly Location
 W = Wafer Lot
 Y = Year
 WW = Work Week
 G = Pb-Free

ORDERING INFORMATION

See detailed ordering and shipping information in the package dimensions section on page 12 of this data sheet.

NOTE: Some of the devices on this data sheet have been **DISCONTINUED**. Please refer to the table on page 12.

NCP5663, NCV5663

PIN FUNCTION DESCRIPTION

Pin Adj/Fixed	Pin Name	Description
1	Enable	This pin allows for on/off control of the regulator. To disable the device, connect to Ground. If this function is not in use, connect to V_{in} .
2	V_{in}	Positive Power Supply Input Voltage
3	Ground	Power Supply Ground
4	V_{out}	Regulated Output Voltage
5	Adj (Adjustable Version)	This pin is connected to the resistor divider network and programs the output voltage.
5	Error Flag (Fixed Version)	An Error Flag is triggered when the output voltage is out of regulation excluding transient signals that may occur. Requires a pullup resistor $\approx 100\text{ k}\Omega$.

NCP5663, NCV5663

ABSOLUTE MAXIMUM RATINGS

Rating	Symbol	Value	Unit
Input Voltage (Note 1)	V_{in}	18	V
Output Pin Voltage	V_{out}	-0.3 to $V_{in} + 0.3$	V
Adjust Pin Voltage	V_{adj}	-0.3 to $V_{in} + 0.3$	V
Enable Pin Voltage	V_{en}	-0.3 to $V_{in} + 0.3$	V
Error Flag Voltage	V_{ef}	-0.3 to $V_{in} + 0.3$	V
Error Flag Current	I_{ef}	3.0	mA
Thermal Characteristics (Note 1) Thermal Resistance Junction-to-Air (Note 2) Thermal Resistance Junction-to-Case	$R_{\theta JA}$ $R_{\theta JC}$	45 5.0	$^{\circ}C/W$
Operating Junction Temperature Range	T_J	-40 to +150	$^{\circ}C$
Storage Temperature Range	T_{stg}	-55 to +150	$^{\circ}C$

Stresses exceeding those listed in the Maximum Ratings table may damage the device. If any of these limits are exceeded, device functionality should not be assumed, damage may occur and reliability may be affected.

NOTE: This device series contains ESD protection and exceeds the following tests:

Human Body Model (HBM) JESD 22-A114-B

Machine Model (MM) JESD 22-A115-A.

1. Refer to Electrical Characteristics table and Application Information section for Safe Operating Area.
2. As measured using a copper heat spreading area of 625 mm², 1 oz. copper thickness.

NCP5663, NCV5663

ELECTRICAL CHARACTERISTICS

($V_{in} - V_{out} = 1.5$ V, for typical values $T_J = 25^\circ\text{C}$, for min/max values $T_J = -40^\circ\text{C}$ to 85°C (125°C for NCV versions), $C_{in} = C_{out} = 150$ μF unless otherwise noted.)

Characteristic	Symbol	Min	Typ	Max	Unit
ADJUSTABLE OUTPUT VERSION					
Input Voltage	V_{in}	2.0	–	9.0	V
Output Noise Voltage	V_n	–	28	–	μV_{rms}
Output Voltage Accuracy $T_J = 25^\circ\text{C}$ ($V_{in} = V_{out} + 1.5$ V to 7.0 V, $I_{out} = 10$ mA to 3.0 A) $T_J = -20$ to $+125^\circ\text{C}$ ($V_{in} = V_{out} + 1.5$ V to 7.0 V, $I_{out} = 10$ mA to 3.0 A) $T_J = -40$ to $+150^\circ\text{C}$ ($V_{in} = V_{out} + 1.5$ V to 7.0 V, $I_{out} = 10$ mA to 3.0 A)	V_{out}	-1% -1.5% -2%	– 0.9 –	+1% +1.5% +2%	V
Adjustable Pin Input Current	I_{adj}	–	40	–	nA
Line Regulation ($I_{out} = 10$ mA, $V_{out} + 1.5$ V < V_{in} < 7.0 V)	REG_{line}	–	0.03	–	%
Load Regulation (10 mA < I_{out} < 3.0 A)	REG_{load}	–	0.03	–	%
Dropout Voltage ($I_{out} = 3.0$ A)	V_{DO}	–	1.0	1.3	V
Peak Output Current Limit	I_{out}	3.0	–	–	A
Internal Current Limitation	I_{lim}	–	4.5	–	A
Ripple Rejection (120 Hz)	RR	–	70	–	dB
Ripple Rejection (1 kHz)		–	65	–	
Thermal Shutdown (Guaranteed by Design)	T_{SHD}	–	160	–	$^\circ\text{C}$
Ground Current $I_{out} = 3.0$ A Disabled State	I_q I_{qds}	– –	1.3 10	3.0 300	mA μA
Enable Input Threshold Voltage Voltage Increasing, On state, Logic High Voltage Decreasing, Off state, Logic Low	V_{en}	1.3 –	– –	– 0.3	V
Enable Input Current Enable Pin Voltage = $0.3 V_{\text{max}}$ Enable Pin Voltage = $1.3 V_{\text{min}}$	I_{en}	– –	0.5 0.5	– –	μA

NCP5663, NCV5663

ELECTRICAL CHARACTERISTICS

($V_{in} - V_{out} = 1.5$ V, for typical values $T_J = 25^\circ\text{C}$, for min/max values $T_J = -40^\circ\text{C}$ to 85°C (125°C for NCV versions), $C_{in} = C_{out} = 150$ μF unless otherwise noted.)

Characteristic	Symbol	Min	Typ	Max	Unit
FIXED OUTPUT VOLTAGE					
Input Voltage	V_{in}	2.0	–	9.0	V
Output Noise Voltage ($V_{out} = 0.9$ V)	V_n	–	28	–	μV_{rms}
Output Voltage Accuracy (Note 3) $T_J = 25^\circ\text{C}$ ($V_{in} = V_{out} + 1.5$ V to 7.0 V, $I_{out} = 10$ mA to 3.0 A) $T_J = -20$ to $+125^\circ\text{C}$ ($V_{in} = V_{out} + 1.5$ V to 7.0 V, $I_{out} = 10$ mA to 3.0 A) $T_J = -40$ to $+150^\circ\text{C}$ ($V_{in} = V_{out} + 1.5$ V to 7.0 V, $I_{out} = 10$ mA to 3.0 A)	V_{out}	-1% -1.5% -2%	– V_{out} –	+1% +1.5% +2%	V
Line Regulation ($I_{out} = 10$ mA, $V_{out} + 1.5$ V < V_{in} < 7.0 V)	REG_{line}	–	0.03	–	%
Load Regulation (10 mA < I_{out} < 3.0 A)	REG_{load}	–	0.2	–	%
Dropout Voltage ($I_{out} = 3.0$ A)	V_{DO}	–	1.0	1.3	V
Peak Output Current Limit	I_{out}	3.0	–	–	A
Internal Current Limitation	I_{lim}	–	4.5	–	A
Ripple Rejection (120 Hz)	RR	–	70	–	dB
Ripple Rejection (1 kHz)		–	65	–	
Thermal Shutdown (Guaranteed by Design)	T_{SHD}	–	160	–	$^\circ\text{C}$
Ground Current $I_{out} = 3.0$ A Disabled State	I_q I_{qds}	– –	1.3 30	3.0 300	mA μA
Enable Input Threshold Voltage Voltage Increasing, On state, Logic High Voltage Decreasing, Off state, Logic Low	V_{en}	1.3 –	– –	– 0.3	V
Enable Input Current Enable Pin Voltage = $0.3 V_{\text{max}}$ Enable Pin Voltage = $1.3 V_{\text{min}}$	I_{en}	– –	0.5 0.5	– –	μA
Error Flag (Fixed Output)	V_{cflt}	91	94	97	% of V_{out}
Error Flag Output Low Voltage Saturation ($I_{ef} = 1.0$ mA)	V_{cfdo}	–	200	–	mV
Error Flag Leakage	I_{efleak}	–	1.0	–	μA
Error Flag Blanking Time (Note 4)	T_{ef}	–	50	–	μs

3. Refer to Ordering Information Table for available voltage options.
 4. Can be disabled per customer request.

NCP5663, NCV5663

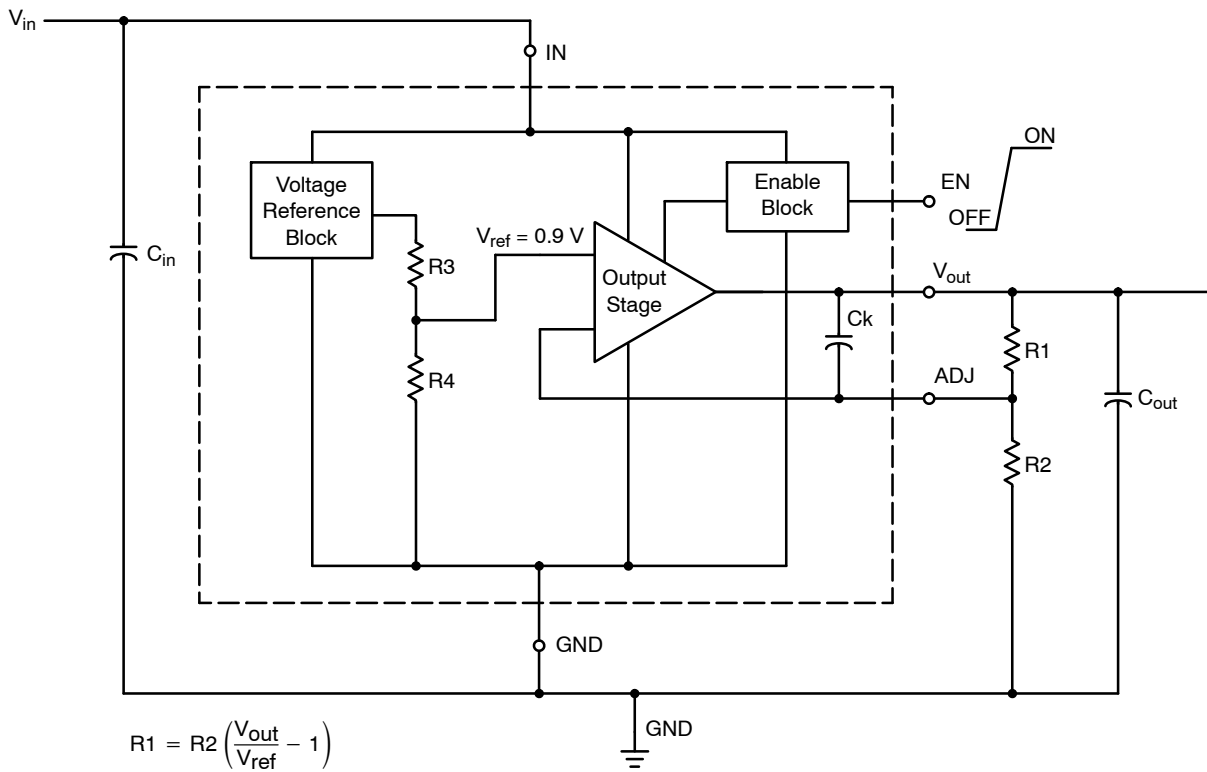

Figure 1. Typical Schematic, Adjustable Output Version

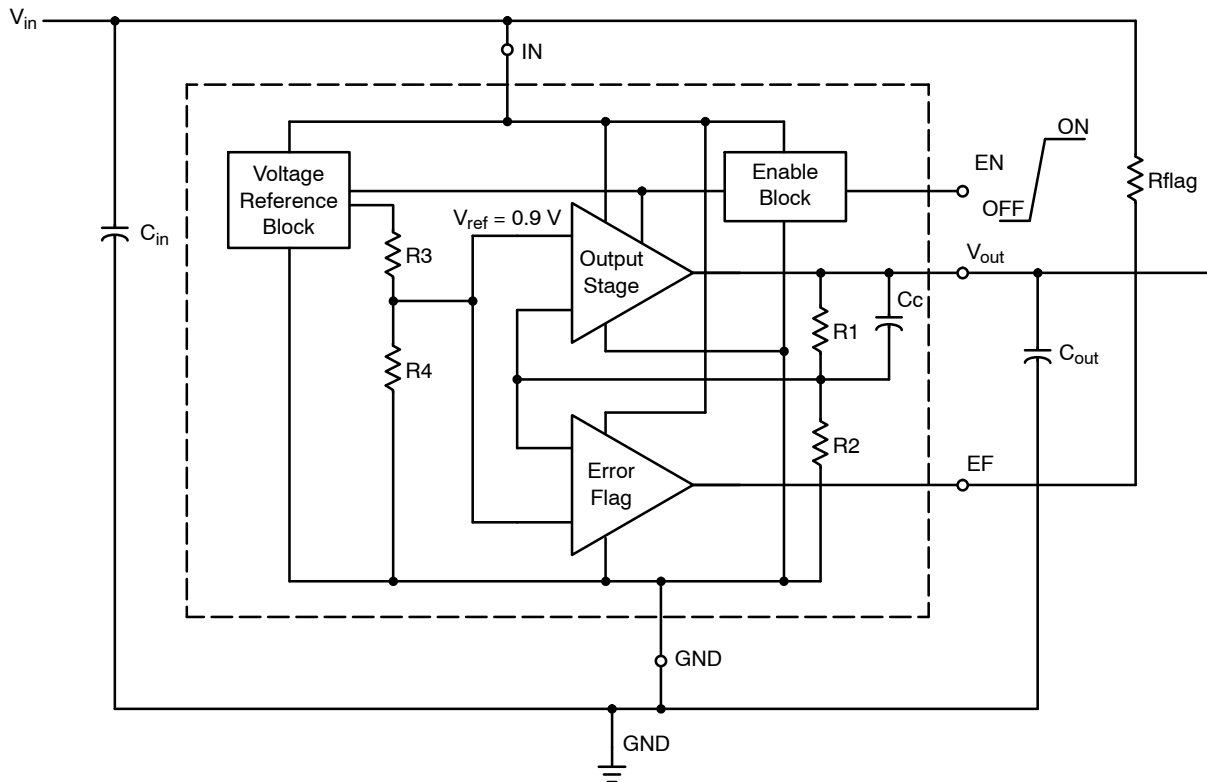

Figure 2. Typical Schematic, Fixed Output Version

NCP5663, NCV5663

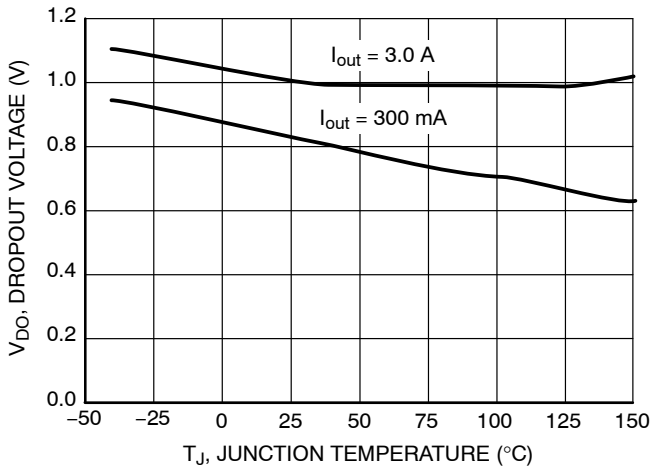

Figure 1. Dropout Voltage vs. Temperature

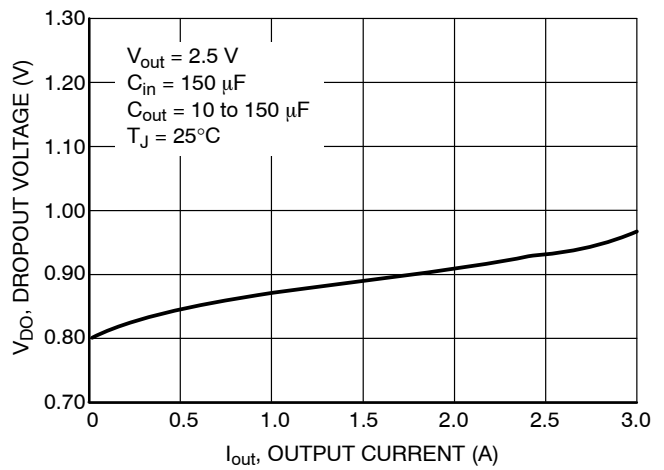

Figure 2. Dropout Voltage vs. Output Current

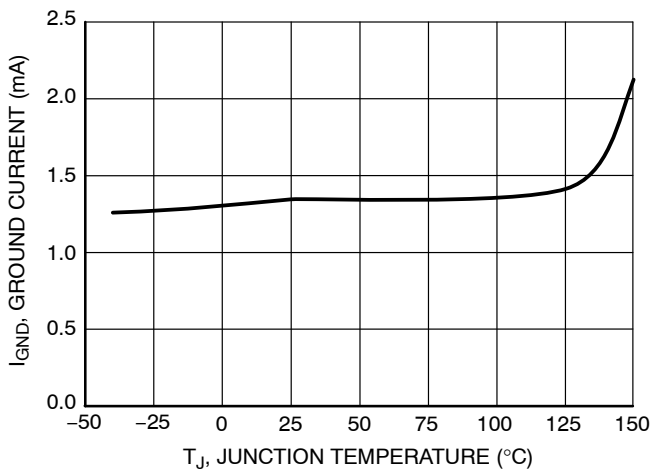

Figure 3. Ground Current vs. Temperature

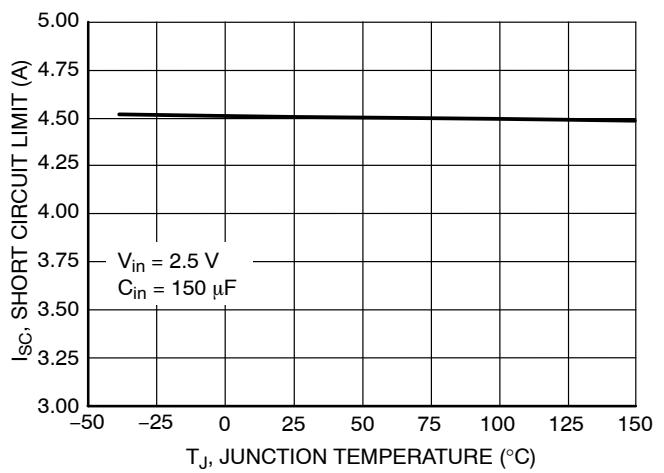

Figure 4. Short Circuit Current Limit vs. Temperature

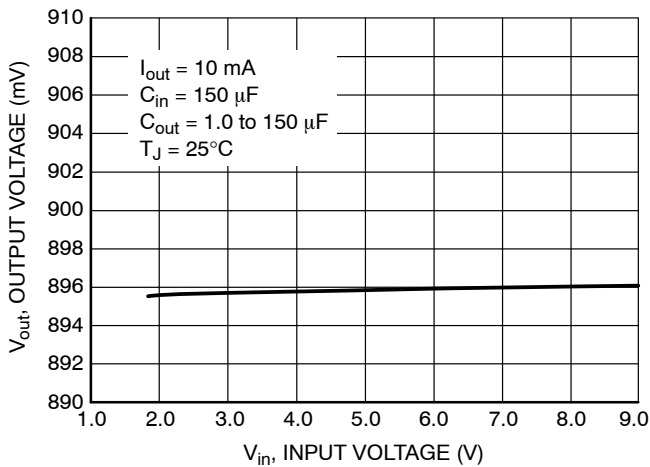

Figure 5. Output Voltage vs. Input Voltage

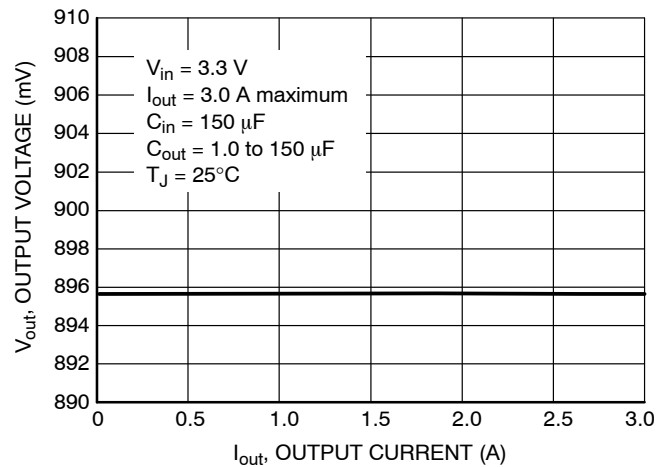

Figure 6. Output Voltage vs. Output Load Current

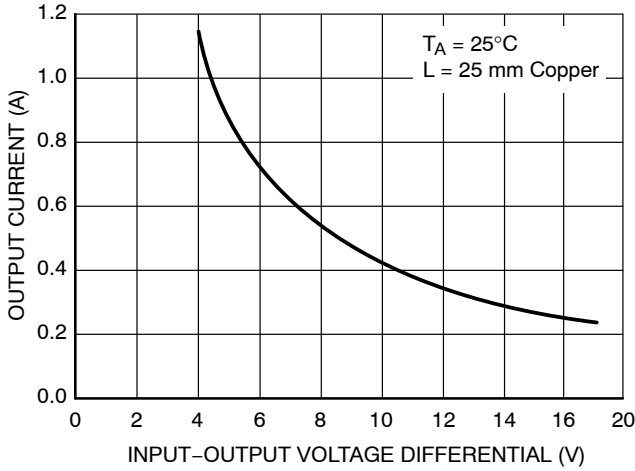

Figure 7. Output Current vs. Input-Output Voltage Differential

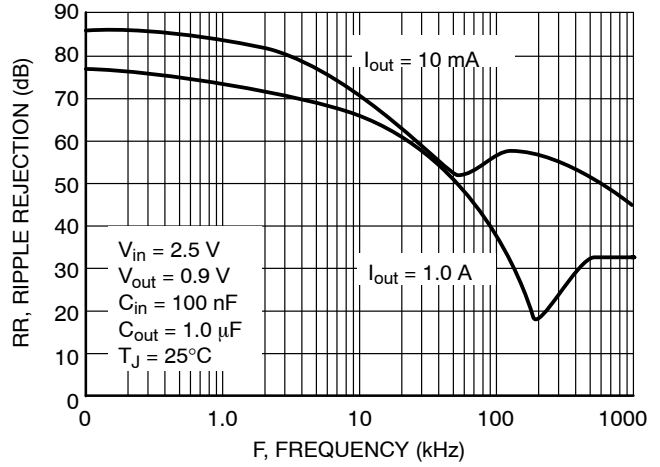

Figure 8. Ripple Rejection vs. Frequency

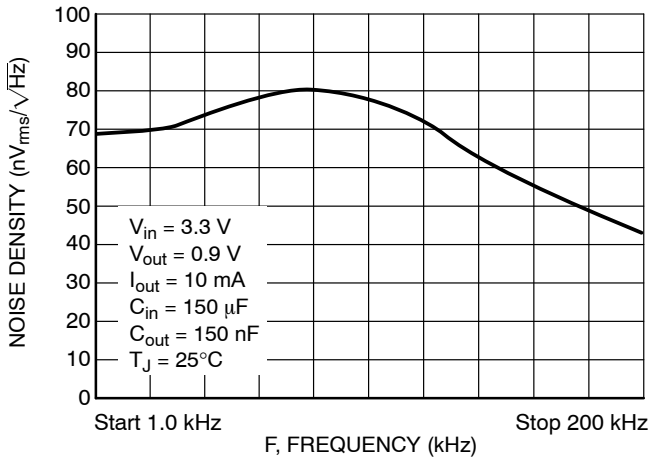

Figure 9. Noise Density vs. Frequency

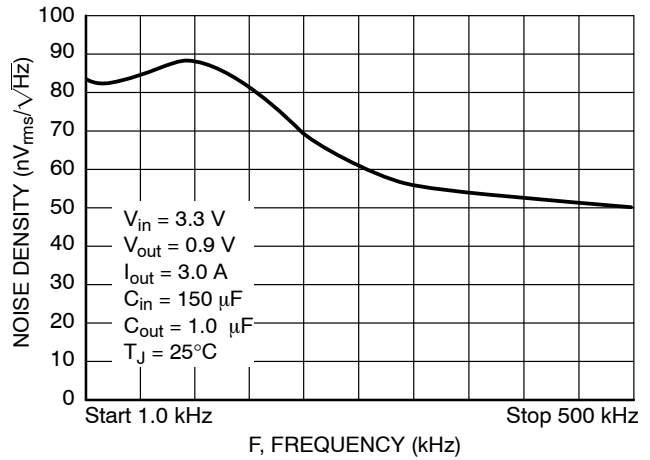

Figure 10. Noise Density vs. Frequency

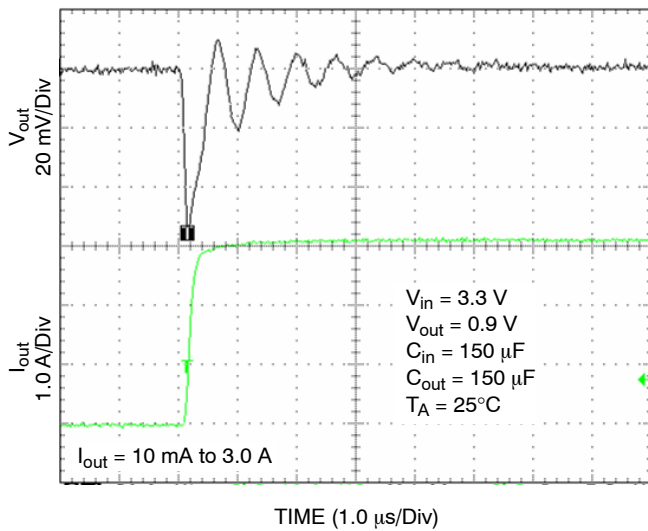

Figure 11. Load Transient Response

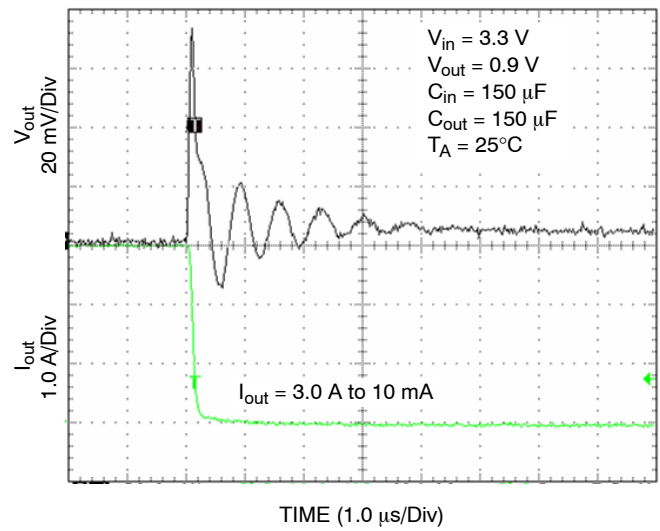

Figure 12. Load Transient Response

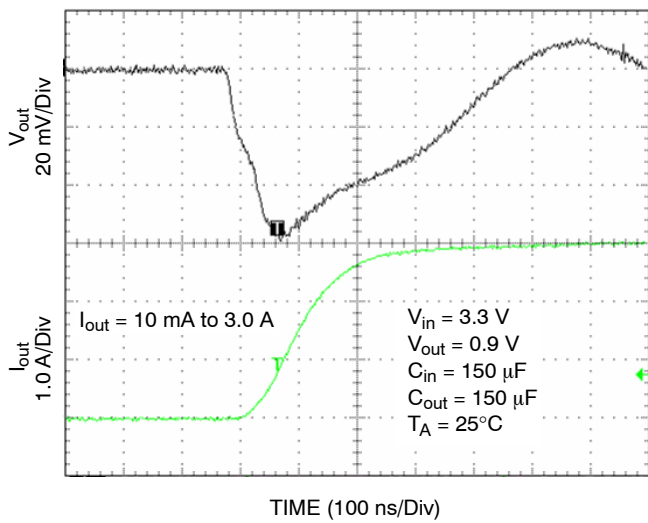

Figure 13. Load Transient Response

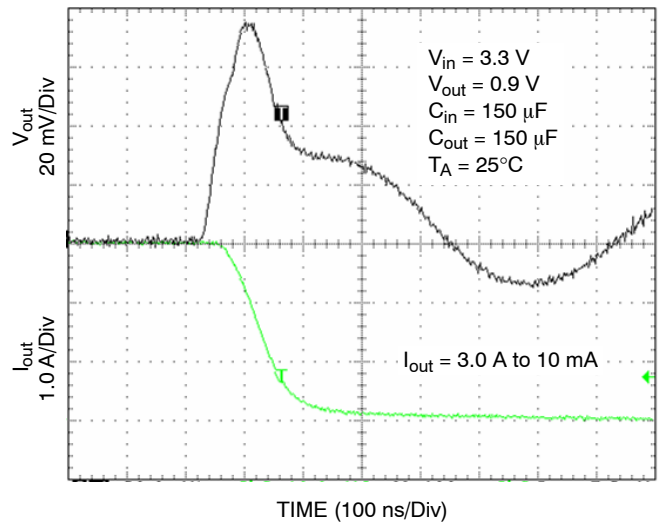

Figure 14. Load Transient Response

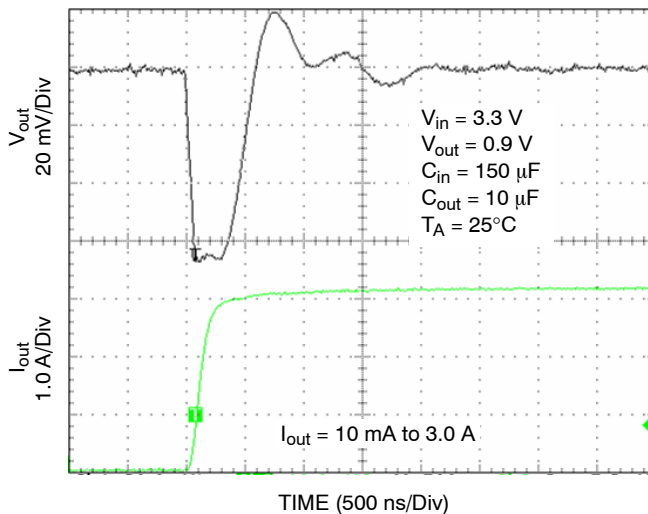

Figure 15. Load Transient Response

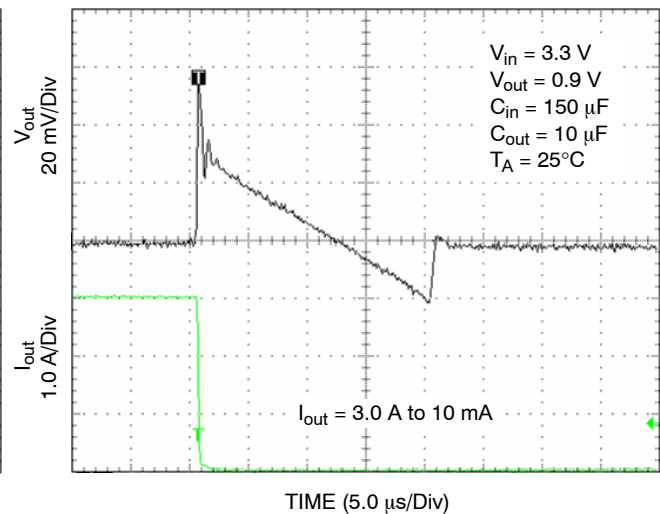

Figure 16. Load Transient Response

APPLICATION INFORMATION

The NCP5663/NCV5663 is a high performance low dropout 3.0 A linear regulator suitable for high power applications, featuring an ultra-fast response time and low noise without a bypass capacitor. It is offered in both fixed and adjustable output versions with voltages as low as 0.9 V. Additional features, such as Enable and Error Flag (fixed output version) increase the utility of the NCP5663/NCV5663. It is thermally robust and includes the safety features necessary during a fault condition, which provide for an attractive high current LDO solution for server, ASIC power supplies, networking equipment applications, and many others.

Input Capacitor

The recommended input capacitor value is a 150 µF OSCON with an Equivalent Series Resistance (ESR) of 50 mΩ. It is especially required if the power source is located more than a few inches from the NCP5663/NCV5663. This capacitor will reduce device sensitivity and enhance the output transient response time. The PCB layout is very important and in order to obtain the optimal solution, the Vin and GND traces should be sufficiently wide to minimize noise and unstable operation.

Output Capacitor

Proper output capacitor selection is required to maintain stability. The NCP5663/NCV5663 is stable for Cout as low as 10 µF (Figures 15 and 16) and guaranteed to be stable at an output capacitance of, Cout > 33 µF with an ESR between 50 mΩ and 300 mΩ over the output current range of 10 mA to 3.0 A. For PCB layout considerations, place the recommended ceramic capacitor close to the output pin and keep the leads short. This should help ensure ultra-fast transient response times.

Adjustable Output Operation

The application circuit for the adjustable output version is shown in Figure 1. The reference voltage is 0.9 V and the adjustable pin current is typically 40 nA. A resistor divider network, R1 and R2, is calculated using the following formula:

$$R1 = R2 \left(\frac{V_{out}}{V_{ref}} - 1 \right)$$

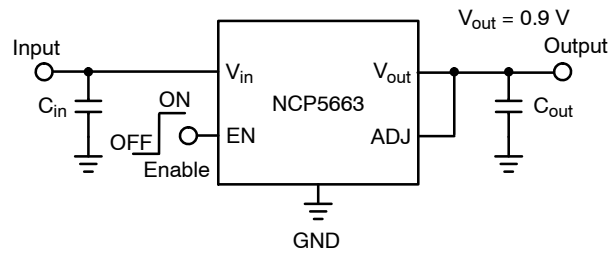

Figure 17. To achieve the minimum output voltage, ADJ to Vout has to be connected together

Current Limit Operation

As the peak output current increases beyond its limitation, the device is internally clamped to 4.5 A, thus causing the output voltage to decrease and go out of regulation. This allows the device never to exceed the maximum power dissipation.

Error Flag Operation

The Error Flag pin on the NCP5663/NCV5663 will produce a logic Low when it drops below the nominal output voltage. Refer to the electrical characteristics for the threshold values at which point the Error Flag goes Low. When the NCP5663/NCV5663 is above the nominal output voltage, the Error Flag will remain at logic High.

The external pullup resistor needs to be connected between Vin and the Error Flag pin. A resistor of approximately 100 kΩ is recommended to minimize the current consumption. No pullup resistor is required if the Error Flag output is not being used.

Thermal Consideration

This series contains an internal thermal limiting circuit that is designed to protect the regulator in the event that the maximum junction temperature is exceeded. This feature provides protection from a catastrophic device failure due to accidental overheating. It is not intended to be used as a substitute for proper heat sinking. The maximum device power dissipation can be calculated by:

$$P_D = \frac{T_{J(max)} - T_A}{R_{\theta JA}}$$

The bipolar process employed for this IC is fully characterized and rated for reliable 18 V VCCmax operation. To avoid damaging the part or degrading its reliability, power dissipation transients should be limited to under 30 W for D²PAK. For open-circuit to short-circuit transient,

$$P_{DTransient} = V_{CCmax} * I_{SC}$$

NCP5663, NCV5663

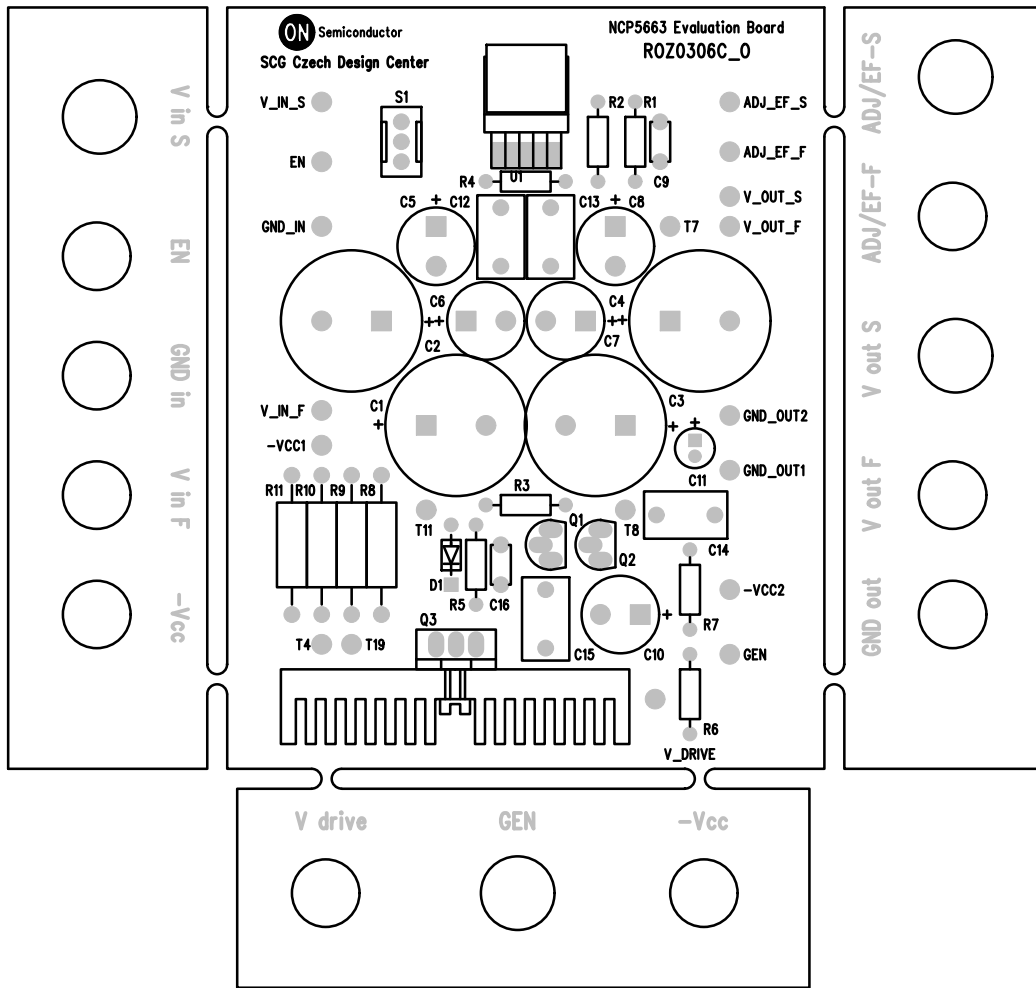

Figure 18. Test Board used for Evaluation

NCP5663, NCV5663

ORDERING INFORMATION

Device	Nominal Output Voltage	Package	Shipping†
NCP5663DSADJR4G	Adj	D ² PAK (Pb-Free)	800 Tape & Reel

DISCONTINUED (Note 6)

NCP5663DS15R4G (Note 5)	Fixed, 1.5 V	D ² PAK (Pb-Free)	800 Tape & Reel
NCP5663DS18R4G (Note 5)	Fixed, 1.8 V		800 Tape & Reel
NCP5663DS18G (Note 5)	Fixed, 1.8 V		50 Units / Rail
NCV5663DSADJR4G*	Adj		800 Tape & Reel
NCV5663DS15R4G* (Note 5)	Fixed, 1.5 V		800 Tape & Reel

5. Other fixed output voltages available at 0.9 V, 1.2 V, 2.5 V, 3.0 V, 3.3 V per request.

†For information on tape and reel specifications, including part orientation and tape sizes, please refer to our Tape and Reel Packaging Specifications Brochure, BRD8011/D.

*NCV Prefix for Automotive and Other Applications Requiring Unique Site and Control Change Requirements; AEC-Q100 Qualified and PPAP Capable

6. **DISCONTINUED:** These devices are not recommended for new design. Please contact your **onsemi** representative for information. The most current information on these devices may be available on www.onsemi.com.

MECHANICAL CASE OUTLINE

PACKAGE DIMENSIONS

ON Semiconductor®



D²PAK 5-LEAD CASE 936A-02 ISSUE E

DATE 28 JUL 2021

SCALE 1:1

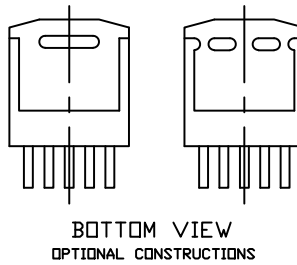
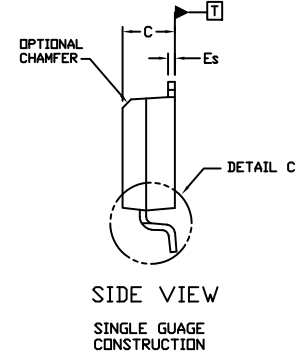
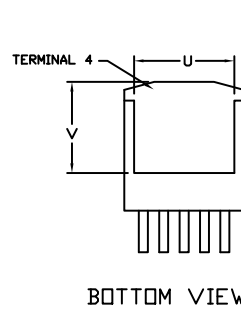
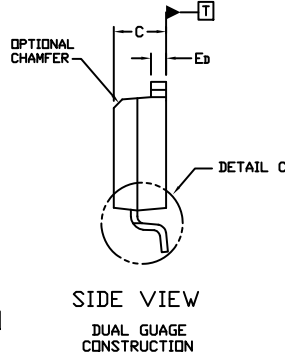
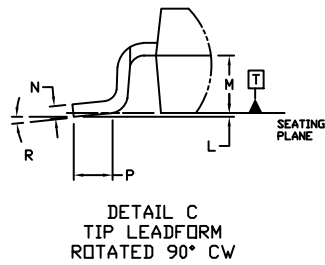

NOTES:

1. DIMENSIONING AND TOLERANCING PER ANSI Y14.5M, 1982.
2. CONTROLLING DIMENSION INCHES
3. TAB CONTOUR OPTIONAL WITHIN DIMENSIONS A AND K.
4. DIMENSIONS U AND V ESTABLISH A MINIMUM MOUNTING SURFACE FOR TERMINAL 4.
5. DIMENSIONS A AND B DO NOT INCLUDE MOLD FLASH OR GATE PROTRUSIONS. MOLD FLASH AND GATE PROTRUSIONS NOT TO EXCEED 0.025 (0.635) MAXIMUM.

DIM	INCHES		MILLIMETERS	
	MIN.	MAX.	MIN.	MAX.
A	0.396	0.403	9.804	10.236
B	0.356	0.368	9.042	9.347
C	0.170	0.180	4.318	4.572
D	0.026	0.036	0.660	0.914
Ed	0.045	0.055	1.143	1.397
Es	0.018	0.026	0.457	0.660
G	0.067	BSC	1.702	BSC
H	0.539	0.579	13.691	14.707
K	0.050	REF	1.270	REF
L	0.000	0.010	0.000	0.254
M	0.088	0.102	2.235	2.591
N	0.018	0.026	0.457	0.660
P	0.058	0.078	1.473	1.981
R	0°	8°	0°	8°
S	0.116	REF	2.946	REF
U	0.200	MIN	5.080	MIN
V	0.250	MIN	6.350	MIN

GENERIC MARKING DIAGRAM*

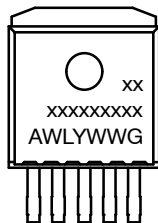

- xxxxxx = Device Code
- A = Assembly Location
- WL = Wafer Lot
- Y = Year
- WW = Work Week
- G = Pb-Free Package

*This information is generic. Please refer to device data sheet for actual part marking. Pb-Free indicator, "G" or microdot "•", may or may not be present. Some products may not follow the Generic Marking.

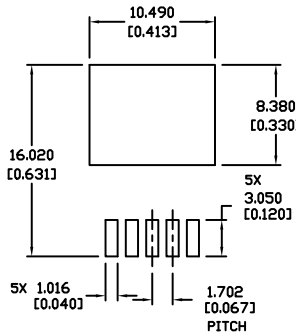

RECOMMENDED MOUNTING FOOTPRINT *

* For additional information on our Pb-Free strategy and soldering details, please download the ON Semiconductor Soldering and Mounting Techniques Reference Manual, SOLDERRM/D.

DOCUMENT NUMBER:	98ASH01006A	Electronic versions are uncontrolled except when accessed directly from the Document Repository. Printed versions are uncontrolled except when stamped "CONTROLLED COPY" in red.
DESCRIPTION:	D2PAK 5-LEAD	PAGE 1 OF 1

ON Semiconductor and are trademarks of Semiconductor Components Industries, LLC dba ON Semiconductor or its subsidiaries in the United States and/or other countries. ON Semiconductor reserves the right to make changes without further notice to any products herein. ON Semiconductor makes no warranty, representation or guarantee regarding the suitability of its products for any particular purpose, nor does ON Semiconductor assume any liability arising out of the application or use of any product or circuit, and specifically disclaims any and all liability, including without limitation special, consequential or incidental damages. ON Semiconductor does not convey any license under its patent rights nor the rights of others.

onsemi, **Onsemi**, and other names, marks, and brands are registered and/or common law trademarks of Semiconductor Components Industries, LLC dba "**onsemi**" or its affiliates and/or subsidiaries in the United States and/or other countries. **onsemi** owns the rights to a number of patents, trademarks, copyrights, trade secrets, and other intellectual property. A listing of **onsemi**'s product/patent coverage may be accessed at www.onsemi.com/site/pdf/Patent-Marking.pdf. **onsemi** reserves the right to make changes at any time to any products or information herein, without notice. The information herein is provided "as-is" and **onsemi** makes no warranty, representation or guarantee regarding the accuracy of the information, product features, availability, functionality, or suitability of its products for any particular purpose, nor does **onsemi** assume any liability arising out of the application or use of any product or circuit, and specifically disclaims any and all liability, including without limitation special, consequential or incidental damages. Buyer is responsible for its products and applications using **onsemi** products, including compliance with all laws, regulations and safety requirements or standards, regardless of any support or applications information provided by **onsemi**. "Typical" parameters which may be provided in **onsemi** data sheets and/or specifications can and do vary in different applications and actual performance may vary over time. All operating parameters, including "Typicals" must be validated for each customer application by customer's technical experts. **onsemi** does not convey any license under any of its intellectual property rights nor the rights of others. **onsemi** products are not designed, intended, or authorized for use as a critical component in life support systems or any FDA Class 3 medical devices or medical devices with a same or similar classification in a foreign jurisdiction or any devices intended for implantation in the human body. Should Buyer purchase or use **onsemi** products for any such unintended or unauthorized application, Buyer shall indemnify and hold **onsemi** and its officers, employees, subsidiaries, affiliates, and distributors harmless against all claims, costs, damages, and expenses, and reasonable attorney fees arising out of, directly or indirectly, any claim of personal injury or death associated with such unintended or unauthorized use, even if such claim alleges that **onsemi** was negligent regarding the design or manufacture of the part. **onsemi** is an Equal Opportunity/Affirmative Action Employer. This literature is subject to all applicable copyright laws and is not for resale in any manner.

ADDITIONAL INFORMATION

TECHNICAL PUBLICATIONS:

Technical Library: www.onsemi.com/design/resources/technical-documentation
onsemi Website: www.onsemi.com

ONLINE SUPPORT: www.onsemi.com/support

For additional information, please contact your local Sales Representative at www.onsemi.com/support/sales