

NCS2005

Operational Amplifier, Low Power, 8 MHz GBW, Rail-to-Rail Input-Output

The NCS2005 provides high performance in a wide range of applications. The NCS2005 offers beyond rail-to-rail input range, full rail-to-rail output swing, large capacitive load driving ability, and low distortion. The inputs can be driven by voltages that exceed both power supply rails, thus eliminating concerns over exceeding the common-mode voltage range. The rail-to-rail output swing capability provides the maximum possible dynamic range at the output. This is particularly important when operating on low supply voltages.

Operating on supplies of 2.2 V to 32 V, the NCS2005 is excellent for a very wide range of applications in low power systems. With a supply current of 1.3 mA, the 8 MHz gain-bandwidth of this device supports applications where faster speeds are required. Placing the amplifier right at the signal source reduces board size and simplifies signal routing. The NCS2005 is available in a space-saving 5-pin SOT-23 package.

Features

- Wide Power Supply Range: 2.2 V to 32 V
- Common Mode Voltage Range Wider than Rail-to-Rail:
 $V_{CM} = -0.1 \text{ V to } 5.1 \text{ V @ } V_S = 5 \text{ V}$
- Wide Gain-bandwidth: 8 MHz typical
- Low Supply Current: 1.3 mA typical
- Stable with a 1 nF Capacitor Load with a Phase Margin over $25^\circ @ V_S = 10 \text{ V}$
- Available in a Space-saving 5-pin SOT23 Package
- These devices are Pb-free, Halogen free/BFR Free and are RoHS Compliant

Typical Applications

- Active Filters
- Voltage Referenced Buffers
- Sensors and Instrumentation
- Microphone Amplifiers
- ASIC Input Drivers
- Portable Communications
- PCMCIA Cards



ON Semiconductor®

www.onsemi.com



SOT23-5
SN SUFFIX
CASE 483

MARKING DIAGRAM

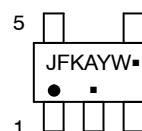

JFK = Specific Device Code
A = Assembly Location
Y = Year
W = Work Week
▪ = Pb-Free Package

(Note: Microdot may be in either location)

PIN DIAGRAM

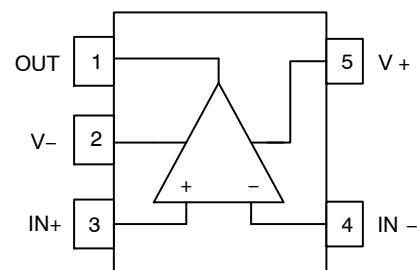

(Top View)

ORDERING INFORMATION

Device	Package	Shipping†
NCS2005SN1T1G	SOT-23 (Pb-Free)	3000 / Tape & Reel

†For information on tape and reel specifications, including part orientation and tape sizes, please refer to our Tape and Reel Packaging Specification Brochure, BRD8011/D.

Table 1. PIN DESCRIPTION

Pin	Name	Type	Description
1	OUT	Output	Amplifier output
2	V-	Power	Negative power supply
3	IN+	Input	Non-inverting input of amplifier
4	IN-	Input	Inverting input of amplifier
5	V+	Power	Positive power supply

Table 2. ABSOLUTE MAXIMUM RATINGS (Note 1)

rating	Symbol	Value	Units
Supply Voltage Range (V+ - V-)	V _S	0 to 35	V
Input Voltage Range	V _{CM}	(V-) - 0.3 V to (V+) + 0.3 V	V
Differential Input Voltage Range	V _{diff}	0 to 15	V
Input Pin Current	I _{IN}	±10	mA
Output Pin Current (Note 2)	I _{OUT}	±20	mA
Supply Current	I _S	25	mA
Maximum Junction Temperature (Note 3)	T _{J(max)}	+150	°C
Storage Temperature Range	T _{stg}	-65 to +150	°C
ESD Capability (Note 4) Human Body Model Charged Device Model	HBM CDM	4000 400	V
Moisture Sensitivity Level (Note 5)	MSL	Level 1	

Stresses exceeding those listed in the Maximum Ratings table may damage the device. If any of these limits are exceeded, device functionality should not be assumed, damage may occur and reliability may be affected.

1. Refer to ELECTRICAL CHARACTERISTICS and APPLICATION INFORMATION for Safe Operating Area.
2. Applies to both single supply and split supply operation. Continuous short circuit operation at elevated ambient temperature can result in exceeding the maximum allowed junction temperature of 150°C.
3. The maximum power dissipation is a function of T_{J(MAX)}, T_{JA}, and T_A. The maximum allowable dissipation at any ambient temperature is P_d = (T_{J(max)} - T_A)/T_{JA}. All numbers apply for packages soldered directly to a PC board.
4. This device series incorporates ESD protection and is tested by the following methods:
ESD Human Body Model tested per JESD22-A114
ESD Charged Device Model tested per ANSI/ESD S5.3.1-2009
5. Moisture Sensitivity Level tested per IPC/JEDEC standard: J-STD-020A

Table 3. THERMAL CHARACTERISTICS

Parameter	Symbol	Package	Single Layer Board	Multi Layer Board	Units
Thermal Resistance Junction-to-Ambient (Note 6)	θ _{JA}	SOT-23-5	408 (Note 6)	355 (Note 7)	°C/W

6. Values based on a 1S standard PCB according to JEDEC51-3 with 1.0 oz copper and a 300 mm² copper area
7. Values based on a 1S2P standard PCB according to JEDEC51-7 with 1.0 oz copper and a 100 mm² copper area

Table 4. OPERATING RANGES

Parameter	Symbol	Min	Max	Units
Power Supply Voltage	V _S	2.2	32	V
Common Mode Input Voltage	V _{CM}	(V-) - 0.1	(V+) + 0.1	V
Ambient Temperature	T _A	-40	125	°C

Functional operation above the stresses listed in the Recommended Operating Ranges is not implied. Extended exposure to stresses beyond the Recommended Operating Ranges limits may affect device reliability.

NCS2005

Table 5. ELECTRICAL CHARACTERISTICS AT 10 V SUPPLY Unless otherwise noted, values are referenced to $T_A = 25^\circ\text{C}$, $V_+ = 10\text{ V}$, $V_- = 0\text{ V}$, $V_{CM} = V_+/2$, and $R_L > 1\text{ M}\Omega$ to $V_+/2$. **Boldface** limits apply from $T_A = -40^\circ\text{C}$ to 125°C . (Notes 8, 9)

Parameter	Test Conditions	Symbol	Min	Typ	Max	Units
-----------	-----------------	--------	-----	-----	-----	-------

SUPPLY CHARACTERISTICS

Quiescent Supply Current	No load	I_S		1.30	1.5	mA
					1.7	
Power Supply Rejection Ratio	$V_S = 2.7\text{ V to }30\text{ V}$	PSRR		113		dB
			70			

INPUT CHARACTERISTICS

Input Offset Voltage		V_{OS}		0.2	6	mV
					6	
Input Offset Voltage Drift		$\Delta V/\Delta T$		1		$\mu\text{V}/^\circ\text{C}$
Input Bias Current	$V_{CM} = 0\text{ V}$	I_{IB}		50	200	nA
					200	
	$V_{CM} = 10\text{ V}$			50	200	
					200	
Input Offset Current	$V_{CM} = 0\text{ V}$	I_{OS}		2	70	nA
					80	
	$V_{CM} = 10\text{ V}$			2	70	
					80	
Input Resistance		R_{IN}		95		$\text{M}\Omega$
Input Capacitance		C_{IN}		3		pF
Common Mode Rejection Ratio	$V_{CM} = V_- \text{ to } V_+$	CMRR	73	84		dB

OUTPUT CHARACTERISTICS

High-level output voltage	$I_L = 10\text{ mA}$	V_{OH}	9.65	9.80		V
Low-Level Output Voltage	$I_L = 10\text{ mA}$	V_{OL}		176	300	mV
Output Current Capability	Sourcing current	I_{OUT}		12		mA
	Sinking current			20		

DYNAMIC PERFORMANCE

Open Loop Voltage Gain	$R_L = 10\text{ k}\Omega$	A_{VOL}	83	107		dB
Gain-Bandwidth Product	$R_L = 10\text{ k}\Omega$	GBWP		8.5		MHz
Gain Margin	$R_L = 10\text{ k}\Omega$	A_M		5.5		dB
Phase Margin	$R_L = 10\text{ k}\Omega$	ψ_M		65		$^\circ$
Slew Rate	$R_L = 10\text{ k}\Omega$	SR		2.8		$\text{V}/\mu\text{s}$
Total Harmonic Distortion Plus Noise	$f_{IN} = 1\text{ kHz}$, $A_V = 2$, $R_L = 2\text{ k}\Omega$	THD+n		0.0015		%

NOISE PERFORMANCE

Voltage Noise Density	$f = 1\text{ kHz}$	e_N		45		$\text{nV}/\sqrt{\text{Hz}}$
-----------------------	--------------------	-------	--	----	--	------------------------------

8. Refer to ABSOLUTE MAXIMUM RATINGS and APPLICATION INFORMATION for Safe Operating Area.

9. Performance guaranteed over the indicated operating temperature range by design and/or characterization tested at $T_J = T_A = 25^\circ\text{C}$.

Product parametric performance is indicated in the Electrical Characteristics for the listed test conditions, unless otherwise noted. Product performance may not be indicated by the Electrical Characteristics if operated under different conditions.

NCS2005

Table 6. ELECTRICAL CHARACTERISTICS AT 5 V SUPPLY Unless otherwise noted, values are referenced to $T_A = 25^\circ\text{C}$, $V_+ = 5\text{ V}$, $V_- = 0\text{ V}$, $V_{CM} = V_+/2$, and $R_L \geq 1\text{ M}\Omega$ to $V_+/2$. **Boldface** limits apply from $T_A = -40^\circ\text{C}$ to 125°C , unless otherwise noted. (Notes 10, 11)

Parameter	Test Conditions	Symbol	Min	Typ	Max	Units
-----------	-----------------	--------	-----	-----	-----	-------

SUPPLY CHARACTERISTICS

Quiescent Supply Current	No load	I_S		1.25		mA
Power Supply Rejection Ratio	$V_S = 2.7\text{ V to }30\text{ V}$	PSRR		113		dB
			70			

INPUT CHARACTERISTICS

Input Offset Voltage		V_{OS}		0.2	6	mV
			6			
Input Offset Voltage Drift		$\Delta V/\Delta T$		1		$\mu\text{V}/^\circ\text{C}$
Input Bias Current	$V_{CM} = 0\text{ V}$	I_{IB}		55		nA
	$V_{CM} = 5\text{ V}$			55		
Input Offset Current	$V_{CM} = 0\text{ V}$	I_{OS}		2		nA
	$V_{CM} = 5\text{ V}$			2		
Input Resistance		R_{IN}		45		$\text{M}\Omega$
Input Capacitance		C_{IN}		3		pF
Common Mode Rejection Ratio	$V_{CM} = V_- \text{ to } V_+$	CMRR	68	90		dB

OUTPUT CHARACTERISTICS

High-level Output Voltage	$I_L = 5\text{ mA}$	V_{OH}	4.75	4.83		V
Low-level Output Voltage	$I_L = 5\text{ mA}$	V_{OL}		130	200	mV
Output Current Capability	Sourcing current	I_{OUT}		12		mA
	Sinking current			20		

DYNAMIC PERFORMANCE

Open Loop Voltage Gain	$R_L = 10\text{ k}\Omega$	A_{VOL}	83	100		dB
Gain-Bandwidth Product	$R_L = 10\text{ k}\Omega$	GBWP		8.5		MHz
Gain Margin	$R_L = 10\text{ k}\Omega$	A_M		5.5		dB
Phase Margin	$R_L = 10\text{ k}\Omega$	ψ_M		65		$^\circ$
Slew Rate	$R_L = 10\text{ k}\Omega$	SR		2.7		$\text{V}/\mu\text{s}$
Total Harmonic Distortion Plus Noise	$f_{IN} = 1\text{ kHz}$, $A_V = 2$, $R_L = 2\text{ k}\Omega$	THD+n		0.002		%

NOISE PERFORMANCE

Voltage Noise Density	$f = 1\text{ kHz}$	e_N		45		$\text{nV}/\sqrt{\text{Hz}}$
-----------------------	--------------------	-------	--	----	--	------------------------------

10. Refer to ABSOLUTE MAXIMUM RATINGS and APPLICATION INFORMATION for Safe Operating Area.

11. Performance guaranteed over the indicated operating temperature range by design and/or characterization tested at $T_J = T_A = 25^\circ\text{C}$.

NCS2005

Table 7. ELECTRICAL CHARACTERISTICS AT 2.7 V SUPPLY Unless otherwise noted, values are referenced to $T_A = 25^\circ\text{C}$, $V_+ = 2.7\text{ V}$, $V_- = 0\text{ V}$, $V_{CM} = V_+/2$, and $R_L \geq 1\text{ M}\Omega$ to $V_+/2$. **Boldface** limits apply from $T_A = -40^\circ\text{C}$ to 125°C , unless otherwise noted. (Notes 12, 13)

Parameter	Test Conditions	Symbol	Min	Typ	Max	Units
-----------	-----------------	--------	-----	-----	-----	-------

SUPPLY CHARACTERISTICS

Quiescent Supply Current	No load	I_S		1.25		mA
Power Supply Rejection Ratio	$V_S = 2.7\text{ V to }30\text{ V}$	PSRR	70	113		dB

INPUT CHARACTERISTICS

Input Offset Voltage		V_{OS}		0.2	6	mV
					6	
Input Offset Voltage Drift		$\Delta V/\Delta T$		1		$\mu\text{V}/^\circ\text{C}$
Input Bias Current	$V_{CM} = 0\text{ V}$	I_{IB}		45		nA
	$V_{CM} = 2.7\text{ V}$			45		
Input Offset Current	$V_{CM} = 0\text{ V}$	I_{OS}		2		nA
	$V_{CM} = 2.7\text{ V}$			2		
Input Resistance		R_{IN}		90		$\text{M}\Omega$
Input Capacitance		C_{IN}		3		pF
Common Mode Rejection Ratio	$V_{CM} = V_-$ to V_+	CMRR	58	96		dB

OUTPUT CHARACTERISTICS

High-Level Output Voltage	$I_L = 2.7\text{ mA}$	V_{OH}	2.50	2.60		V
Low-Level Output Voltage	$I_L = 2.7\text{ mA}$	V_{OL}		100	130	mV
Output Current Capability	Sourcing current	I_{OUT}		12		mA
	Sinking current			20		

DYNAMIC PERFORMANCE

Open Loop Voltage Gain	$R_L = 10\text{ k}\Omega$	A_{VOL}	73	114		dB
Gain-Bandwidth Product	$R_L = 10\text{ k}\Omega$	GBWP		8.5		MHz
Gain Margin	$R_L = 10\text{ k}\Omega$	A_M		6		dB
Phase Margin	$R_L = 10\text{ k}\Omega$	ψ_M		60		$^\circ$
Slew Rate	$R_L = 10\text{ k}\Omega$	SR		2.6		$\text{V}/\mu\text{s}$
Total Harmonic Distortion Plus Noise	$f_{IN} = 1\text{ kHz}$, $A_V = 2$, $R_L = 2\text{ k}\Omega$	THD+n		0.05		%

NOISE PERFORMANCE

Voltage Noise Density	$f = 1\text{ kHz}$	e_N		45		$\text{nV}/\sqrt{\text{Hz}}$
-----------------------	--------------------	-------	--	----	--	------------------------------

12. Refer to ABSOLUTE MAXIMUM RATINGS and APPLICATION INFORMATION for Safe Operating Area.

13. Performance guaranteed over the indicated operating temperature range by design and/or characterization tested at $T_J = T_A = 25^\circ\text{C}$.

TYPICAL CHARACTERISTICS

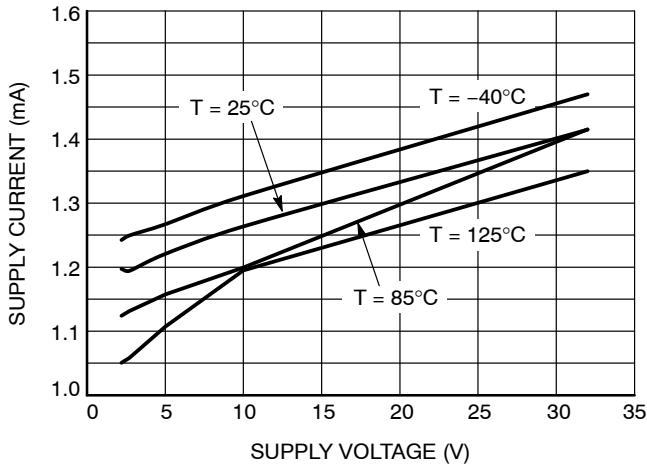

Figure 1. Quiescent Current Per Channel vs. Supply Voltage

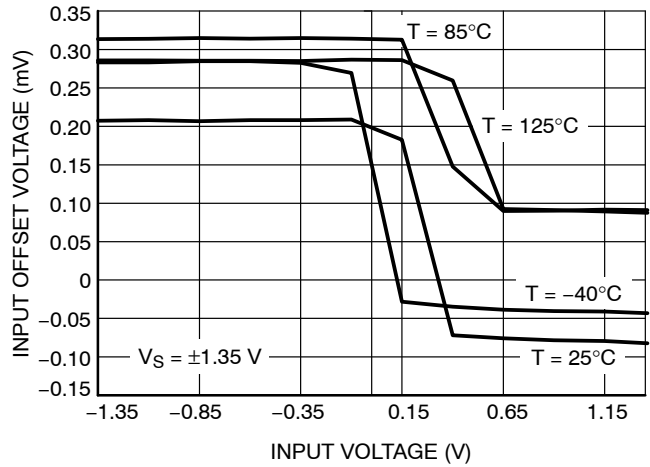

Figure 2. Input Offset Voltage vs. Common Mode Input Voltage

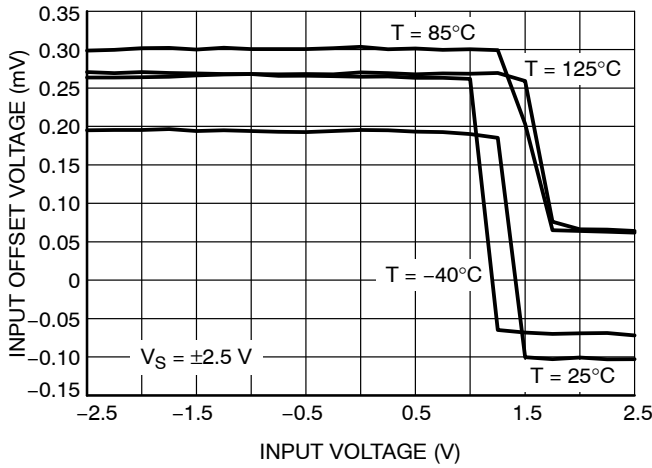

Figure 3. Input Offset Voltage vs. Common Mode Input Voltage

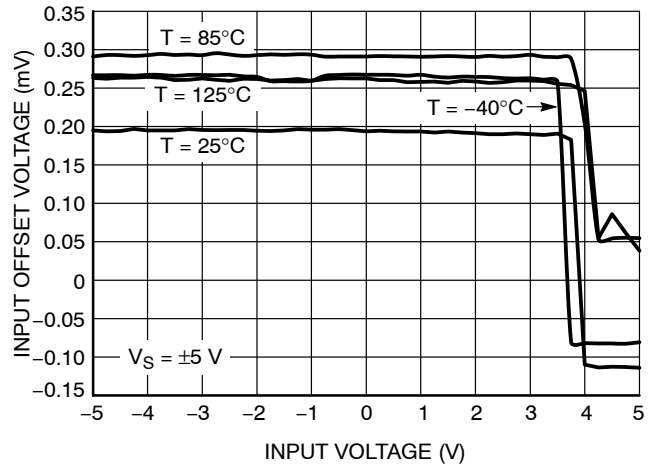

Figure 4. Input Offset Voltage vs. Common Mode Voltage

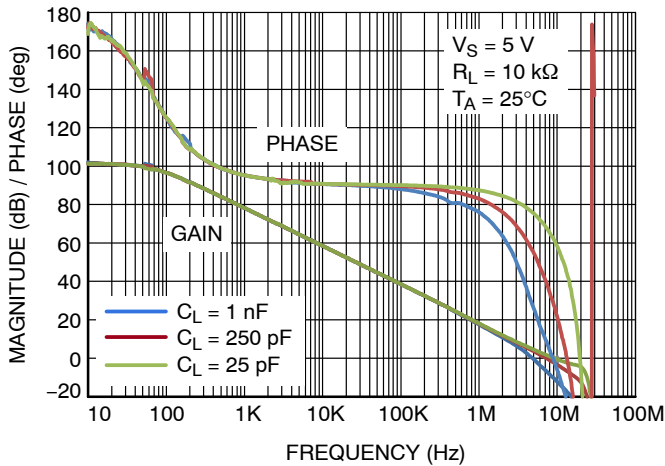

Figure 5. Gain and Phase vs. Frequency

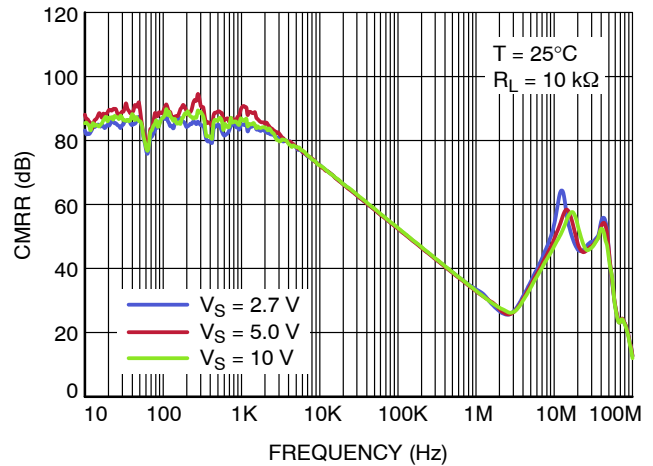

Figure 6. CMRR vs. Frequency

TYPICAL CHARACTERISTICS

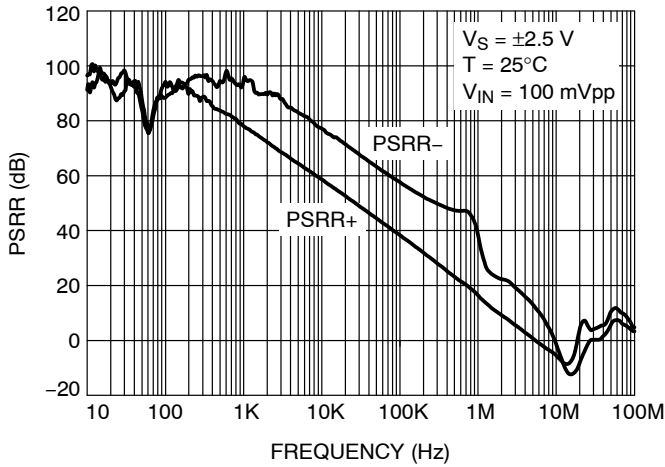

Figure 7. PSRR vs. Frequency

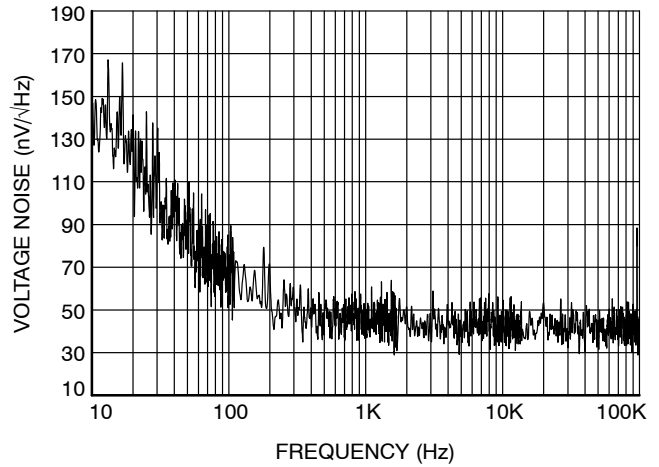

Figure 8. Input Voltage Noise vs. Frequency

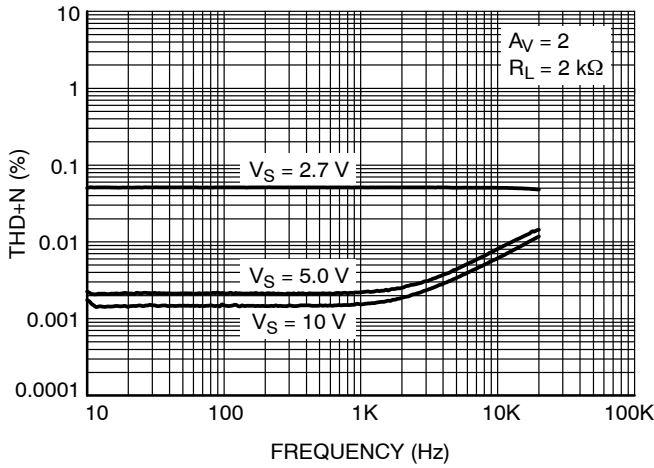

Figure 9. THD+N vs. Frequency

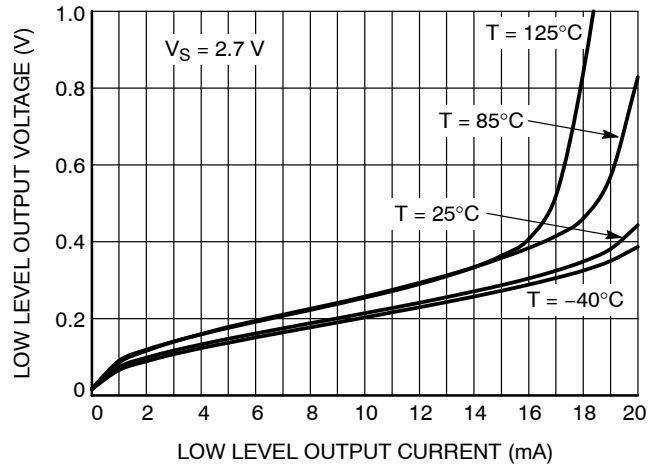

Figure 10. Low Level Output Voltage vs. Output Current @ VS = 2.7 V

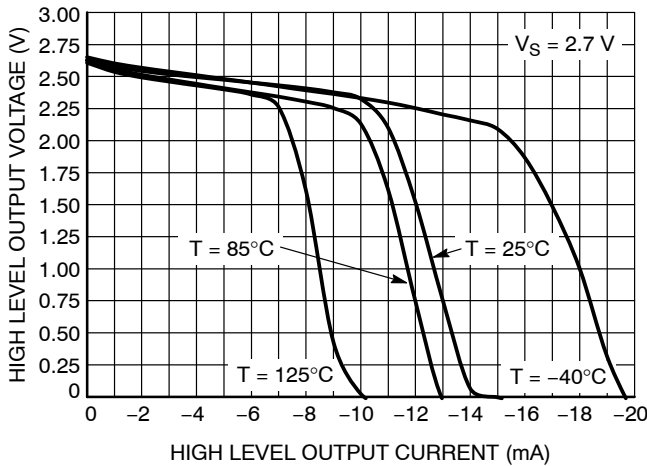

Figure 11. High Level Output Voltage vs. Output Current @ VS = 2.7 V

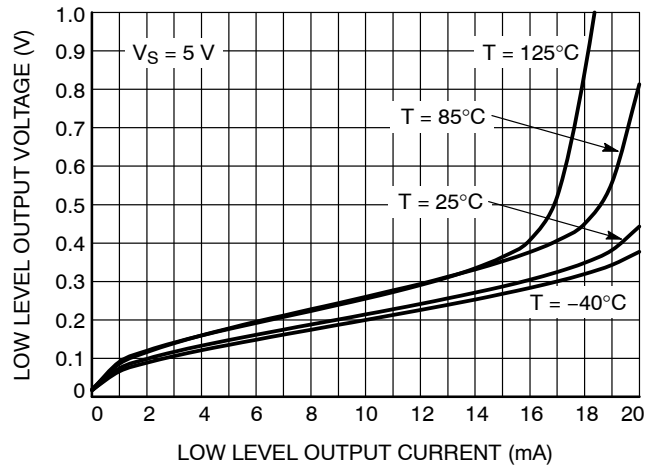

Figure 12. Low Level Output Voltage vs. Output Current @ VS = 5 V

TYPICAL CHARACTERISTICS

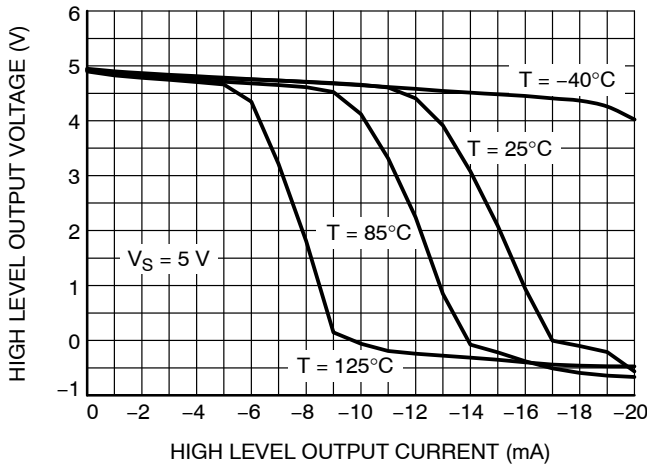

Figure 13. Low Level Output Voltage vs. Output Current

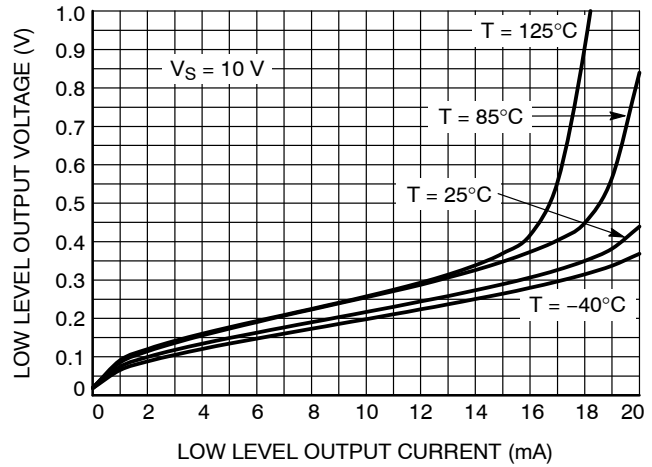

Figure 14. High Level Output Voltage vs. Output Current

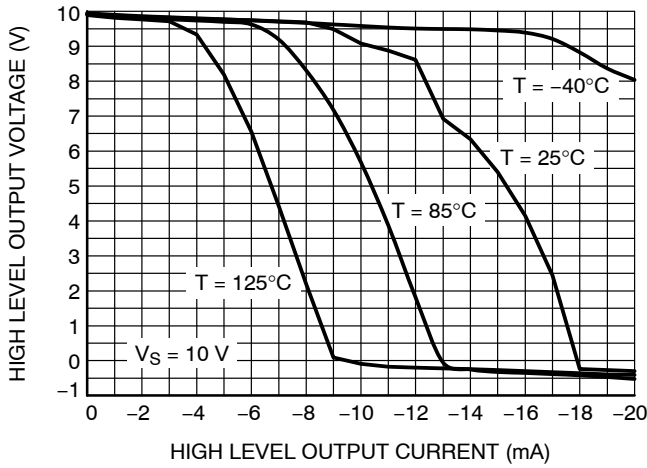

Figure 15. Low Level Output Voltage vs. Output Current

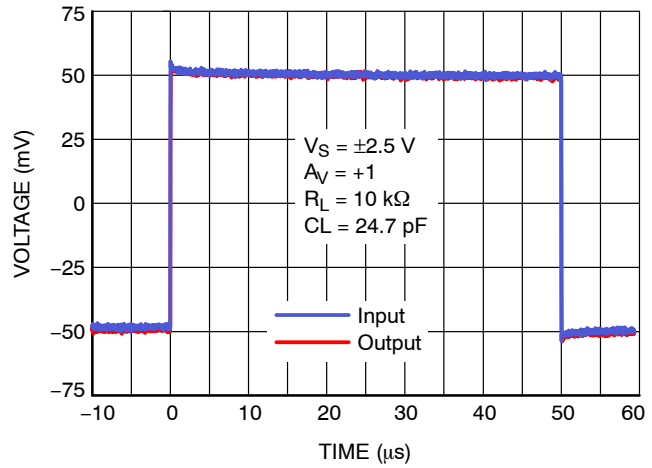

Figure 16. Non-inverting Small Signal Transient Response

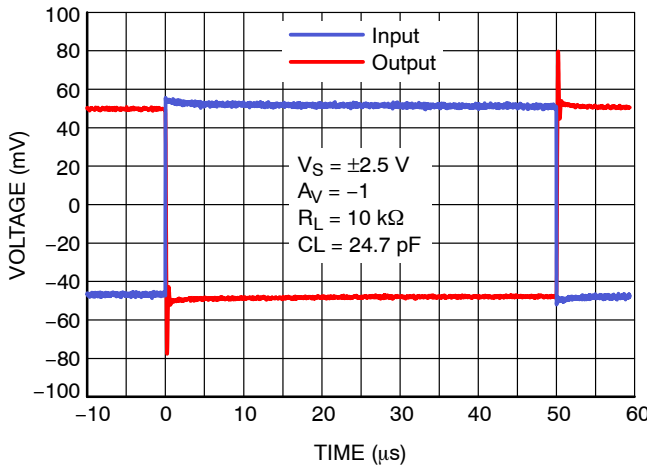

Figure 17. Inverting Small Signal Transient Response

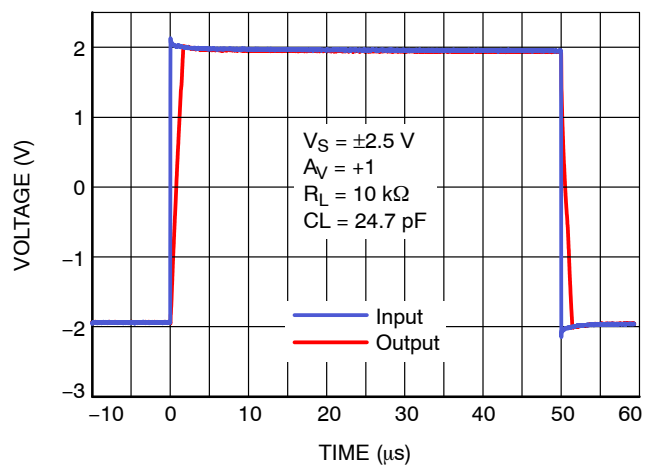

Figure 18. Non-Inverting Large Signal Transient Response

TYPICAL CHARACTERISTICS

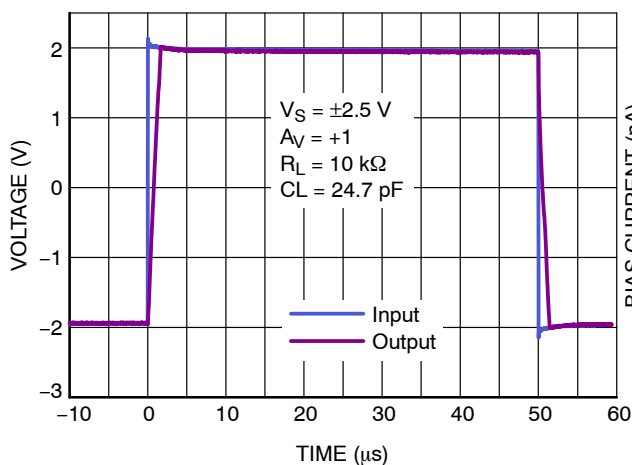

Figure 19. Inverting Large Signal Transient Response

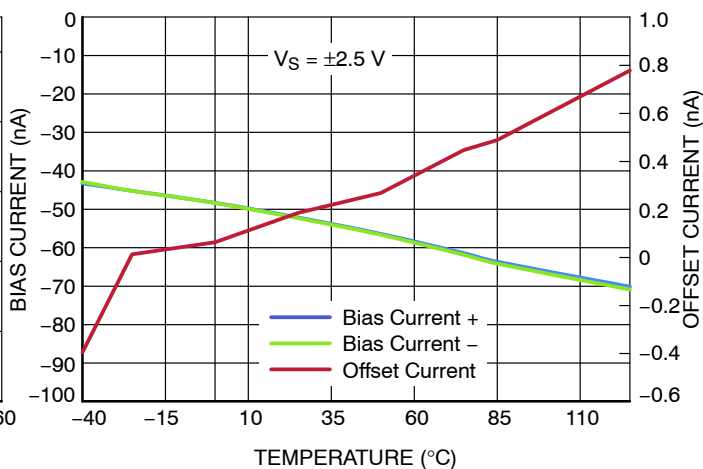
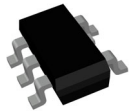

Figure 20. Input Bias and Offset Current vs. Temperature

MECHANICAL CASE OUTLINE PACKAGE DIMENSIONS



TSOP-5 3.00x1.50x0.95, 0.95P CASE 483 ISSUE P

DATE 01 APR 2024

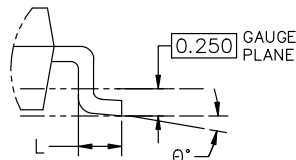

NOTES:

1. DIMENSIONING AND TOLERANCING CONFORM TO ASME Y14.5-2018.
2. ALL DIMENSION ARE IN MILLIMETERS (ANGLES IN DEGREES).
3. MAXIMUM LEAD THICKNESS INCLUDES LEAD FINISH THICKNESS. MINIMUM LEAD THICKNESS IS THE MINIMUM THICKNESS OF BASE MATERIAL.
4. DIMENSIONS D AND E1 DO NOT INCLUDE MOLD FLASH, PROTRUSIONS OF GATE BURRS. MOLD FLASH, PROTRUSIONS, OR GATE BURRS SHALL NOT EXCEED 0.15 PER SIDE. DIMENSION D.
5. OPTIONAL CONSTRUCTION: AN ADDITIONAL TRIMMED LEAD IS ALLOWED IN THIS LOCATION. TRIMMED LEAD NOT TO EXTEND MORE THAN 0.2 FROM BODY.

DIM	MILLIMETERS		
	MIN.	NOM.	MAX.
A	0.900	1.000	1.100
A1	0.010	0.055	0.100
A2	0.950 REF.		
b	0.250	0.375	0.500
c	0.100	0.180	0.260
D	2.850	3.000	3.150
E	2.500	2.750	3.000
E1	1.350	1.500	1.650
e	0.950 BSC		
L	0.200	0.400	0.600
θ	0°	5°	10°

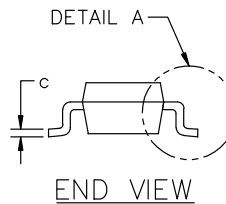

GENERIC MARKING DIAGRAM*

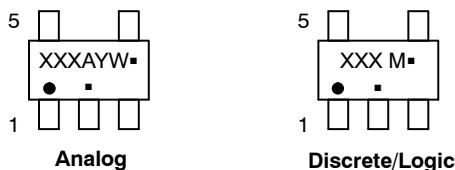

- XXX = Specific Device Code XXX = Specific Device Code
 A = Assembly Location M = Date Code
 Y = Year ▪ = Pb-Free Package
 W = Work Week
- = Pb-Free Package

(Note: Microdot may be in either location)

*This information is generic. Please refer to device data sheet for actual part marking. Pb-Free indicator, "G" or microdot "▪", may or may not be present. Some products may not follow the Generic Marking.

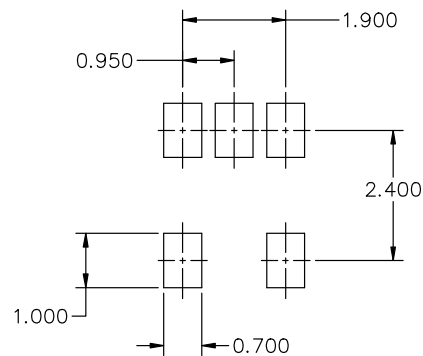

* FOR ADDITIONAL INFORMATION ON OUR Pb-FREE STRATEGY AND SOLDERING DETAILS, PLEASE DOWNLOAD THE ON SEMICONDUCTOR SOLDERING AND MOUNTING TECHNIQUES REFERENCE MANUAL, SOLDERM/D.

DOCUMENT NUMBER:	98ARB18753C	Electronic versions are uncontrolled except when accessed directly from the Document Repository. Printed versions are uncontrolled except when stamped "CONTROLLED COPY" in red.
DESCRIPTION:	TSOP-5 3.00x1.50x0.95, 0.95P	PAGE 1 OF 1

onsemi and ONSEMI are trademarks of Semiconductor Components Industries, LLC dba onsemi or its subsidiaries in the United States and/or other countries. onsemi reserves the right to make changes without further notice to any products herein. onsemi makes no warranty, representation or guarantee regarding the suitability of its products for any particular purpose, nor does onsemi assume any liability arising out of the application or use of any product or circuit, and specifically disclaims any and all liability, including without limitation special, consequential or incidental damages. onsemi does not convey any license under its patent rights nor the rights of others.

onsemi, **Onsemi**, and other names, marks, and brands are registered and/or common law trademarks of Semiconductor Components Industries, LLC dba "**onsemi**" or its affiliates and/or subsidiaries in the United States and/or other countries. **onsemi** owns the rights to a number of patents, trademarks, copyrights, trade secrets, and other intellectual property. A listing of **onsemi**'s product/patent coverage may be accessed at www.onsemi.com/site/pdf/Patent-Marking.pdf. **onsemi** reserves the right to make changes at any time to any products or information herein, without notice. The information herein is provided "as-is" and **onsemi** makes no warranty, representation or guarantee regarding the accuracy of the information, product features, availability, functionality, or suitability of its products for any particular purpose, nor does **onsemi** assume any liability arising out of the application or use of any product or circuit, and specifically disclaims any and all liability, including without limitation special, consequential or incidental damages. Buyer is responsible for its products and applications using **onsemi** products, including compliance with all laws, regulations and safety requirements or standards, regardless of any support or applications information provided by **onsemi**. "Typical" parameters which may be provided in **onsemi** data sheets and/or specifications can and do vary in different applications and actual performance may vary over time. All operating parameters, including "Typicals" must be validated for each customer application by customer's technical experts. **onsemi** does not convey any license under any of its intellectual property rights nor the rights of others. **onsemi** products are not designed, intended, or authorized for use as a critical component in life support systems or any FDA Class 3 medical devices or medical devices with a same or similar classification in a foreign jurisdiction or any devices intended for implantation in the human body. Should Buyer purchase or use **onsemi** products for any such unintended or unauthorized application, Buyer shall indemnify and hold **onsemi** and its officers, employees, subsidiaries, affiliates, and distributors harmless against all claims, costs, damages, and expenses, and reasonable attorney fees arising out of, directly or indirectly, any claim of personal injury or death associated with such unintended or unauthorized use, even if such claim alleges that **onsemi** was negligent regarding the design or manufacture of the part. **onsemi** is an Equal Opportunity/Affirmative Action Employer. This literature is subject to all applicable copyright laws and is not for resale in any manner.

ADDITIONAL INFORMATION

TECHNICAL PUBLICATIONS:

Technical Library: www.onsemi.com/design/resources/technical-documentation
onsemi Website: www.onsemi.com

ONLINE SUPPORT: www.onsemi.com/support

For additional information, please contact your local Sales Representative at www.onsemi.com/support/sales