

NCV7721

Dual Half-Bridge Driver with Parallel Input Control

The NCV7721 is a fully protected Dual Half-Bridge Driver designed specifically for automotive and industrial motion control applications. The two half-bridge drivers have independent control. This allows for high side, low side, and H-Bridge control. H-Bridge control provides forward, reverse, brake, and high impedance states (with EN = low).

The drivers are controlled via logic level inputs.

The device is available in a SOIC-14 package.

Features

- 2 High-side and 2 Low-side Drivers Connected as Half-bridges
- 500 mA [typ], 1.1 A [max] Drivers
 - ♦ $R_{DS(on)} = 0.8 \Omega$ (typ), 1.7Ω (max)
- Internal Free-wheeling Diodes
- Parallel Input Logic Control
- Ultra Low Quiescent Current in Sleep Mode, $1 \mu A$ for V_S and V_{CC}
- Compliance with 5 V and 3.3 V Systems
- Overvoltage and Undervoltage Lockout
- Fault Reporting for Underload, Overcurrent and Thermal Shutdown
- 3 A Current Limit
- Internally Fused Leads in SOIC-14 for Better Thermal Performance
- ESD Protection up to 6 kV
- This is a Pb-Free Device

Applications

- Automotive
- Industrial
- DC Motor Management



ON Semiconductor®

www.onsemi.com

MARKING DIAGRAM

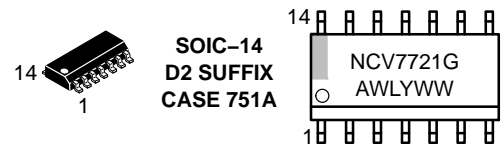

NCV7721G = Specific Device Code

A = Assembly Location
WL = Wafer Lot
Y = Year
WW = Work Week
G = Pb-Free Package

PIN CONNECTIONS

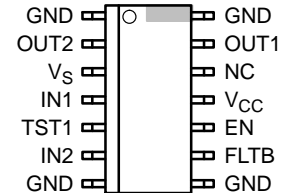

ORDERING INFORMATION

Device	Package	Shipping†
NCV7721D2R2G	SOIC-14 (Pb-Free)	2500 / Tape & Reel

†For information on tape and reel specifications, including part orientation and tape sizes, please refer to our Tape and Reel Packaging Specifications Brochure, BRD8011/D.

NCV7721

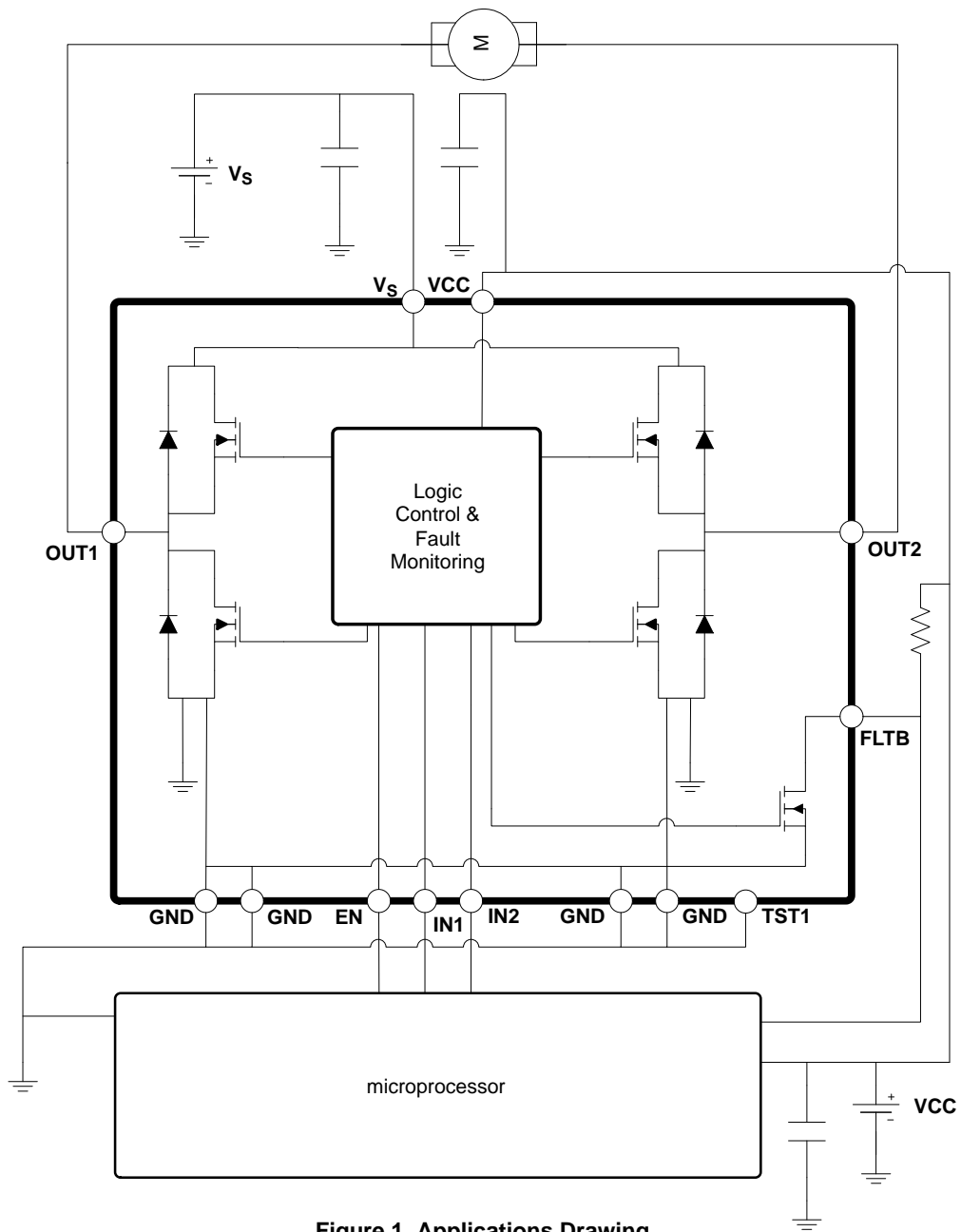

Figure 1. Applications Drawing

NCV7721

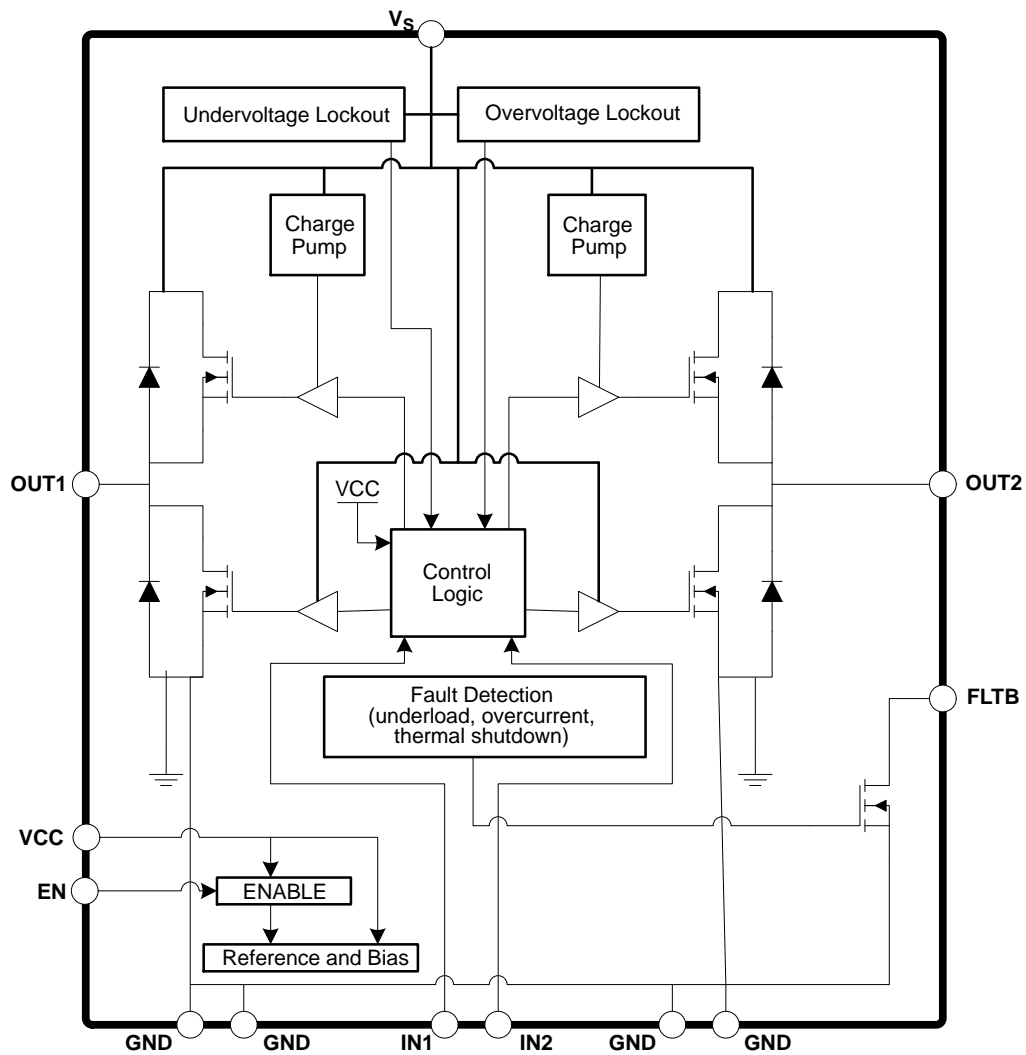

Figure 2. Block Diagram

Table 1. PIN FUNCTION DESCRIPTION

SSIC-14 Fused Package		
Pin #	Symbol	Description
1	GND*	Ground. Connect all grounds together.
2	OUT2	Half Bridge Output 2.
3	V _S	Power Supply input for the output driver and internal supply voltage.
4	IN1	Logic level input for OUT1.
5	TST1	Test pin (ground pin).
6	IN2	Logic level input for OUT2.
7	GND*	Ground. Connect all grounds together.
8	GND*	Ground. Connect all grounds together.
9	FLT _B	Fault Bar. Faults are reported (low) for underload, overload, and thermal shutdown.
10	EN	Enable. A high enables the device.
11	V _{CC}	Power supply input for internal logic.
12	NC	No Connection.
13	OUT1	Half Bridge Output 1.
14	GND*	Ground. Connect all grounds together.

*Pins 1, 7, 8 and 14 are internally shorted together. It is recommended to also short these pins externally.

NCV7721

Table 2. MAXIMUM RATINGS (Voltages are with respect to device substrate.)

Rating	Value	Unit
Power Supply Voltage (V_S) DC AC, $t < 500$ ms, $I_{V_S} > -2$ A	-0.3 to 40 -1	V
Output Pin OUTx DC AC, $t < 500$ ms, $I_{V_S} > -2$ A	-0.3 to 40 -1	V
Pin Voltage (IN1, IN2, EN, VCC) (FLTb)	-0.3 to 5.5 -0.3 to (VCC + 0.3)	V
Output Current (OUTx) DC AC, 50 ms pulse, 1s period	-1.8 to 1.8 -4.0 to 4.0	A
Electrostatic Discharge, Human Body Model (V_S , OUT1, OUT2) (Note 3)	6	kV
Electrostatic Discharge, Human Body Model All other pins (Note 3)	2	kV
Electrostatic Discharge, Machine Model All pins	200	V
Moisture Sensitivity Level	MSL3	-
Operating Junction Temperature, T_J	-40 to 150	°C
Storage Temperature Range	-55 to 150	°C
Peak Reflow Soldering Temperature: Lead-free 60 to 150 seconds at 217°C (Note 4)	260 peak	°C

Stresses exceeding those listed in the Maximum Ratings table may damage the device. If any of these limits are exceeded, device functionality should not be assumed, damage may occur and reliability may be affected.

Thermal Parameters	Test Conditions (Typical Value)		Unit
	Min-pad board (Note 1)	1" pad board (Note 2)	
14 Pin Fused SOIC Package			
Junction-to-Lead (ψ_{JL8} , Ψ_{JL8}) or Pins 1, 7, 8, 14	23	22	°C/W
Junction-to-Ambient ($R_{\theta JA}$, θ_{JA})	122	83	°C/W

- 1-oz copper, 67 mm² copper area, 0.062" thick FR4.
- 1-oz copper, 645 mm² copper area, 0.062", thick FR4.
- This device series incorporates ESD protection and is characterized by the following methods:
ESD HBM according to AEC-Q100-002 (EIA/JESD22-A114)
ESD MM according to AEC-Q100-003 (EIA/JESD22-A115)
- For additional information, see or download ON Semiconductor's Soldering and Mounting Techniques Reference Manual, SOLDERRM/D, and Application Note AND8003/D.

NCV7721

Table 3. ELECTRICAL CHARACTERISTICS

 (−40°C ≤ T_J ≤ 150°C, 5.5 V < V_S < 40 V, 3.15 V < V_{CC} < 5.25 V, EN = V_{CC}, unless otherwise specified.)

Characteristic	Conditions	Min	Typ	Max	Unit
GENERAL					
Supply Current (V _S) Sleep Mode (Note 5)	V _S = 13.2 V, OUTx = 0 V EN = IN1 = IN2 = 0 V 0 V < V _{CC} < 5.25 V T _J = −40°C to 85°C	–	1.0	5.0	μA
	V _S = 13.2 V, OUTx = 0 V EN = IN1 = IN2 = 0 V 0 V < V _{CC} < 5.25 V T _J = 25°C	–	–	2.0	μA
Supply Current (V _S) Active Mode	EN = V _{CC} , 5.5 V < V _S < 35 V No Load	–	2.0	4.0	mA
Supply Current (V _{CC}) Sleep Mode (Note 6)	EN = IN1 = IN2 = 0 V T _J = −40°C to 85°C	–	0.1	2.5	μA
Supply Current (V _{CC}) Active Mode	EN = V _{CC}	–	1.5	3.0	mA
V _{CC} Power-On_Reset Threshold		–	2.55	2.90	V
V _S Undervoltage Detection Threshold Hysteresis	V _S decreasing	3.7	4.1	4.5	V
		100	365	450	mV
V _S Overvoltage Detection Threshold Hysteresis	V _S increasing	33.0	36.5	40.0	V
		1.0	2.5	4.0	
Thermal Shutdown Threshold (Note 4)		155	175	195	°C
OUTPUTS					
Output Rds(on) (Source)	I _{out} = −500 mA	–	–	1.7	Ω
Output Rds(on) (Sink)	I _{out} = 500 mA	–	–	1.7	Ω
Source Leakage Current Sum of OUT1 and OUT2	OUTx = 0 V, V _S = 40 V, EN = 0 V IN1 = IN2 = 0 V 0 V < V _{CC} < 5.25 V Sum(I(OUTx))	−5.0	–	–	μA
	OUTx = 0 V, V _S = 40 V, EN = 0 V IN1 = IN2 = 0 V 0 V < V _{CC} < 5.25 V, T _J = 25°C Sum(I(OUTx))	−1.0	–	–	
Sink Leakage Current	OUTx = V _S = 40 V, EN = 0 V IN1 = IN2 = 0 V 0V < V _{CC} < 5.25 V	–	–	300	μA
	OUTx = V _S = 13.2 V, EN = 0 V IN1 = IN2 = 0 V 0 V < V _{CC} < 5.25 V, T _J = 25°C	–	–	10	
Under Load Detection Threshold Source Sink		−17	−7.0	−2.0	mA
		2.0	7.0	17	
Power Transistor Body Diode Forward Voltage	I _f = 500 mA	–	0.9	1.3	V

NCV7721

Table 3. ELECTRICAL CHARACTERISTICS

($-40^{\circ}\text{C} \leq T_J \leq 150^{\circ}\text{C}$, $5.5\text{ V} < V_S < 40\text{ V}$, $3.15\text{ V} < V_{CC} < 5.25\text{ V}$, $\text{EN} = V_{CC}$, unless otherwise specified.)

Characteristic	Conditions	Min	Typ	Max	Unit
OVERCURRENT					
Overcurrent Shutdown Threshold (OUTHx)	$V_{CC} = 5\text{ V}$, $V_S = 13.2\text{ V}$	-2.0	-1.45	-1.1	A
Overcurrent Shutdown Threshold (OUTLx)	$V_{CC} = 5\text{ V}$, $V_S = 13.2\text{ V}$	1.1	1.45	2.0	A
CURRENT LIMIT					
Current Limit (OUTHx)	$V_{CC} = 5\text{ V}$, $V_S = 13.2\text{ V}$	-5.0	-3.0	-2.0	A
Current Limit (OUTLx)	$V_{CC} = 5\text{ V}$, $V_S = 13.2\text{ V}$	2.0	3.0	5.0	A
LOGIC INPUTS (EN, IN1, IN2)					
Input Threshold	High Low	2.0 -	- -	- 0.8	V
Input Hysteresis		100	400	800	mV
Pulldown Resistance		50	125	250	k Ω
Input Capacitance		-	10	15	pF
LOGIC OUTPUT (FLTB)					
Output Low	$I_{\text{FLTB}} = 1.25\text{ mA}$ $I_{\text{FLTB}} = 10\text{ mA}$	- -	0.08 0.6	0.25 1.1	V
Output Leakage	$\text{EN} = 5\text{ V}$, $0\text{ V} < \text{FLTB} < V_{CC}$	-	-	1	μA
TIMING SPECIFICATIONS					
Under Load Detection Time		200	350	600	μs
Overcurrent Shutdown Delay Time	$V_S = 13.2\text{ V}$, $R_{\text{load}} = 25\ \Omega$	10	25	50	μs
High Side Turn-on Time	$V_S = 13.2\text{ V}$, $R_{\text{load}} = 25\ \Omega$	-	7.5	15	μs
High Side Turn-off Time	$V_S = 13.2\text{ V}$, $R_{\text{load}} = 25\ \Omega$	-	3.0	6.0	μs
Low Side Turn-on Time	$V_S = 13.2\text{ V}$, $R_{\text{load}} = 25\ \Omega$	-	6.5	15	μs
Low Side Turn-off Time	$V_S = 13.2\text{ V}$, $R_{\text{load}} = 25\ \Omega$	-	3.0	6.0	μs
High Side Rise Time	$V_S = 13.2\text{ V}$, $R_{\text{load}} = 25\ \Omega$	-	5.0	10	μs
High Side Fall Time	$V_S = 13.2\text{ V}$, $R_{\text{load}} = 25\ \Omega$	-	2.0	5.0	μs
Low Side Rise Time	$V_S = 13.2\text{ V}$, $R_{\text{load}} = 25\ \Omega$	-	1.0	3.0	μs
Low Side Fall Time	$V_S = 13.2\text{ V}$, $R_{\text{load}} = 25\ \Omega$	-	1.0	3.0	μs
NonOverlap Time	High Side Turn-off to Low Side Turn-on	1.0	-	-	μs
NonOverlap Time	Low Side Turn-off to High Side Turn on	1.0	-	-	μs
Enable Turn-on Time (high-side driver)	$\text{INx} = \text{high}$, $R_{\text{load}} = 25\ \Omega$ to GND EN going high through 50% to OUTx going high through 50%	-	50	-	μs
Enable Turn-on Time (low-side driver)	$\text{INx} = \text{low}$, $R_{\text{load}} = 25\ \Omega$ to V_S EN going high through 50% to OUTx going low through 50%	-	50	-	μs
Enable Turn-off Time (high-side driver)	$\text{INx} = \text{high}$, $R_{\text{load}} = 25\ \Omega$ to GND EN going low through 50% to OUTx going low through 50%	-	2.5	-	μs
Enable Turn-off Time (low-side driver)	$\text{INx} = \text{low}$, $R_{\text{load}} = 25\ \Omega$ to V_S EN going low through 50% to OUTx going high through 50%	-	2.5	-	μs

Product parametric performance is indicated in the Electrical Characteristics for the listed test conditions, unless otherwise noted. Product performance may not be indicated by the Electrical Characteristics if operated under different conditions.

TYPICAL CHARACTERISTICS

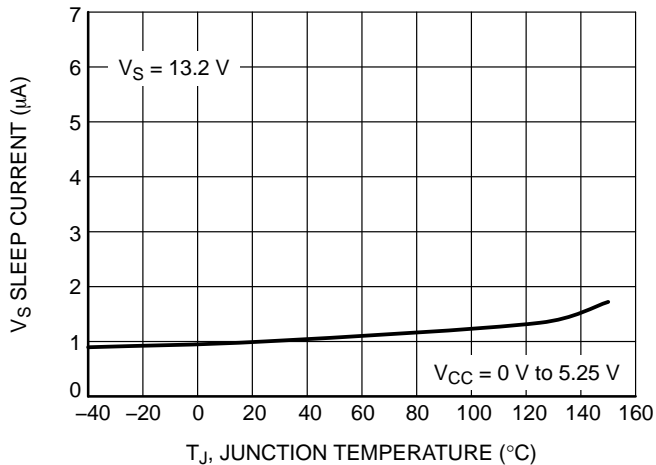

Figure 3. V_S Sleep Supply Current vs. Temperature

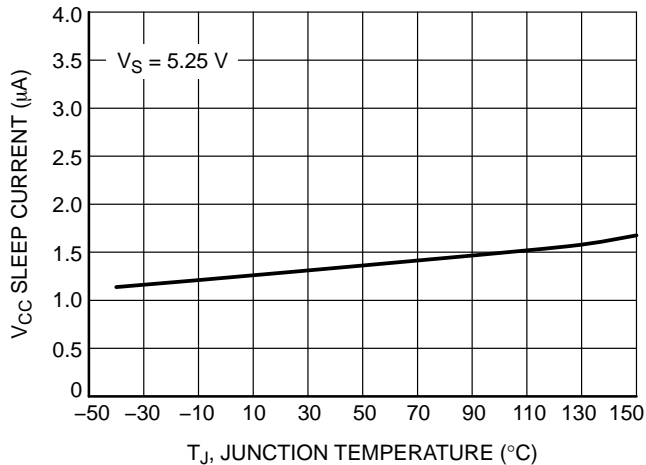

Figure 4. V_{CC} Sleep Supply Current vs. Temperature

TYPICAL CHARACTERISTICS

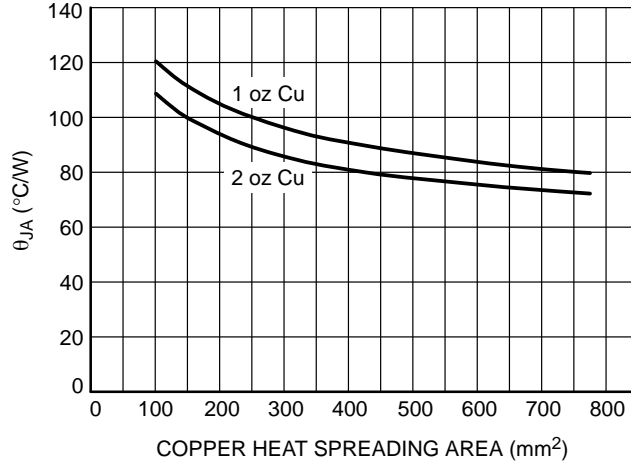

Figure 5. θ_{JA} vs. Copper Spreader Area, 14 Lead SON (fused leads)

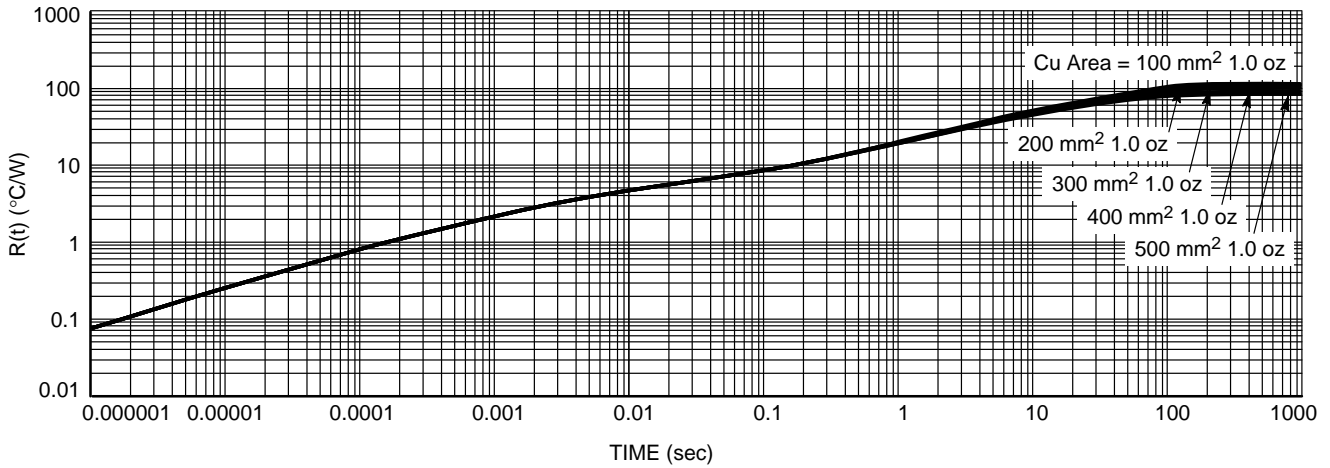

Figure 6. Transient Thermal Response to a Single Pulse 1 oz Copper (Log-Log)

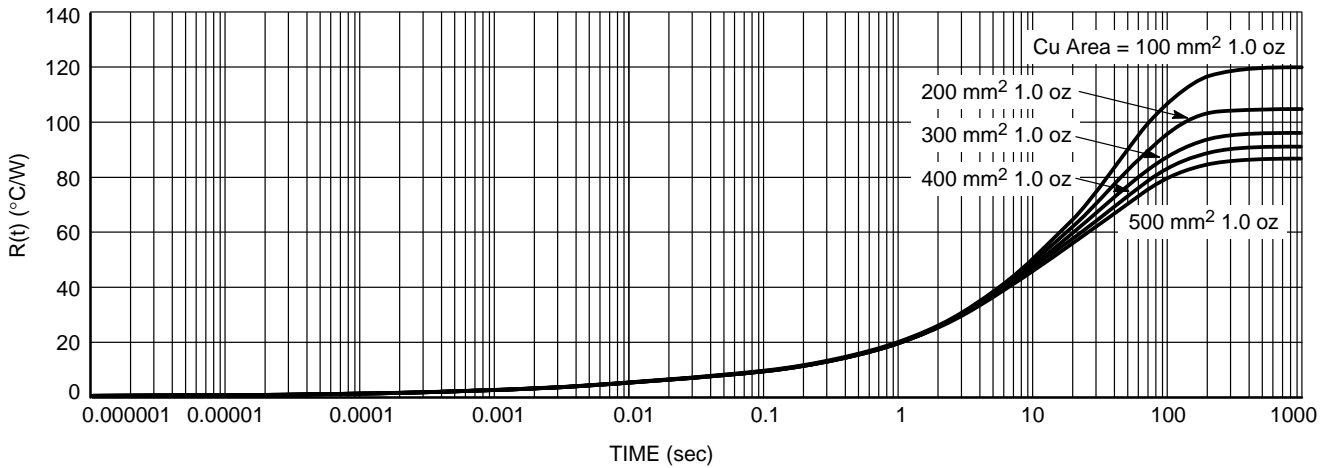

Figure 7. Transient Thermal Response to a Single Pulse 1 oz Copper (Semi-Log)

DETAILED OPERATING DESCRIPTION

General

The NCV7721 Dual Half Bridge Driver provides drive capability for 2 Half-Bridge configurations. Each output drive is characterized for a 500 mA load with capability up to 1.1 A (min overvoltage shutdown threshold). Strict adherence to the integrated circuit die temperature is necessary, with a maximum die temperature of 150°C. Output drive control is handled via the parallel input control pins (IN1 & IN2). A single open Drain output reports underload, overload, and thermal shutdown faults.

An Enable function (EN) provides a low quiescent sleep current mode when the device is not being utilized. A resistor pulldown is provided on EN, IN1, and IN2 to insure a predictive state (low) in the event of a detached input signal.

Power Up/Down Control (Undervoltage Detection)

A feature incorporated in the NCV7721 is an undervoltage lockout circuit that prevents the output drivers from turning on unintentionally. VCC and V_S are monitored for undervoltage conditions supporting a smooth turn-on transition. All drivers are initialized in the off (high impedance) condition, and will remain off during a VCC or V_S undervoltage condition. This allows power up sequencing of VCC and V_S up to the user. Hysteresis in the UVLO circuits results in glitch free operation during power up/down.

Overvoltage Shutdown

Overvoltage lockout monitors the voltage on the V_S pin. When the overvoltage voltage threshold is breached (36.5 V [typ]), all outputs will turn off and remain off until V_S is out of overvoltage. A typical voltage hysteresis of 2.5 V eliminates the possibility of oscillation at the shutdown threshold.

H-Bridge Driver Configuration

The NCV7721 has the flexibility of controlling each half bridge driver independently through the IN1 and IN2 logic input pins. This allows for high-side, low side and H-Bridge control. H-bridge control provides forward, reverse, brake and high impedance states.

Overvoltage Clamping – Driving Inductive Loads

Each output is internally clamped to ground and V_S by internal freewheeling diodes. The diodes have ratings that complement the FETs they protect. A flyback event from

driving an inductive load causes the voltage on the output to rise up. Once the voltage rises higher than V_S by a diode voltage (body diode of the high-side driver), the energy in the inductor will dissipate through the diode to V_S . If a reverse battery diode is used in the system, care must be taken to insure the power supply capacitor is sufficient to dampen any increase in voltage to V_S caused by the current flow through the body diode so that it is below 40 V. Negative transients will momentarily occur when a high-side driver driving an inductive load is turned off. This will be clamped by an internal diode from the output pin (OUT1 or OUT2) to the IC ground.

Current Limit

OUTx current is limited per the Current Limit electrical parameter for each driver. The magnitude of the current has a minimum specification of 2 A at VCC = 5 V and V_S = 13.2 V. The output is protected for high power conditions during Current Limit by thermal shutdown and the Overcurrent Detection shutdown function. Overcurrent Detection shutdown protects the device during current limit because the Overcurrent threshold is below the Current Limit threshold. The Over current Detection Shutdown Control Timer is initiated at the Overcurrent Shutdown Threshold which starts before the Current Limit is reached.

Note: High currents will cause a rise in die temperature. Devices will not be allowed to turn on if the die temperature exceeds the thermal shutdown temperature.

Overcurrent Shutdown

Effected outputs will turn off when the Overcurrent Shutdown Threshold has been breached for the Overcurrent Shutdown Delay Time. FLTb will report a low and the driver will latch off. The driver can only be turned back on by a toggle of the EN pin or a power on reset of VCC.

Overcurrent Detection Shut Down Timer

There are two protection mechanisms for output current, overcurrent and current limit.

1. Current Limit – Maximum current for OUT1 and OUT2.
2. Overcurrent Detection – Threshold at which timer starts.

Figure 8 shows the typical performance of a part which has exceeded the 1.45 A (typ) Overcurrent Detection threshold and started the shutdown timer.

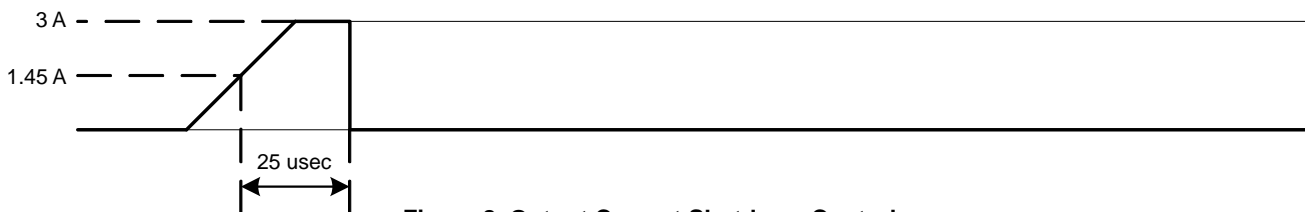

Figure 8. Output Current Shutdown Control

Underload Detection

The underload detection circuit monitors the current from each output driver. A minimum load current (this is the maximum open circuit detection threshold) is required when the drivers are turned on. If the underload detection threshold has been detected continuously for more than the underload delay time, FLTb will report a low. There is no change to the driver condition (remains in the active state). The fault can be cleared by a toggle of the EN pin or a power on reset of VCC.

The NCV7721 uses a global underload timer. An underload condition starts the global under load delay timer. If

under load occurs in another channel after the global timer has been started, the delay for any subsequent underload will be the remainder of the initially started timer. The timer runs continuously with any persistent underload condition and will impact the time for multi underload situations. Figures 9 and 10 highlight the timing conditions for an underload state where the global timer is reset (discontinuous time) and the conditions where the global timer is not reset (continuous time).

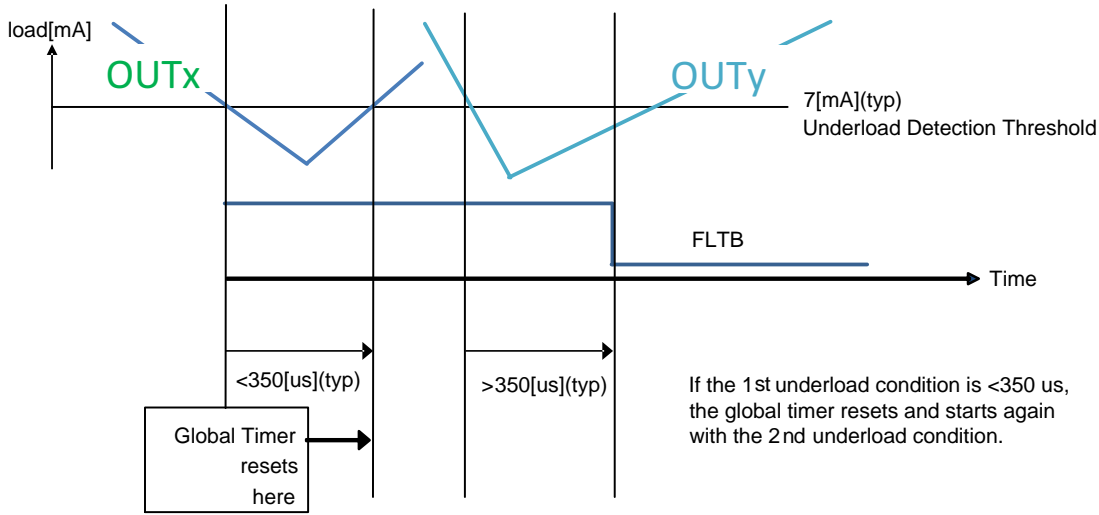

Figure 9. Underload Discontinuous Time

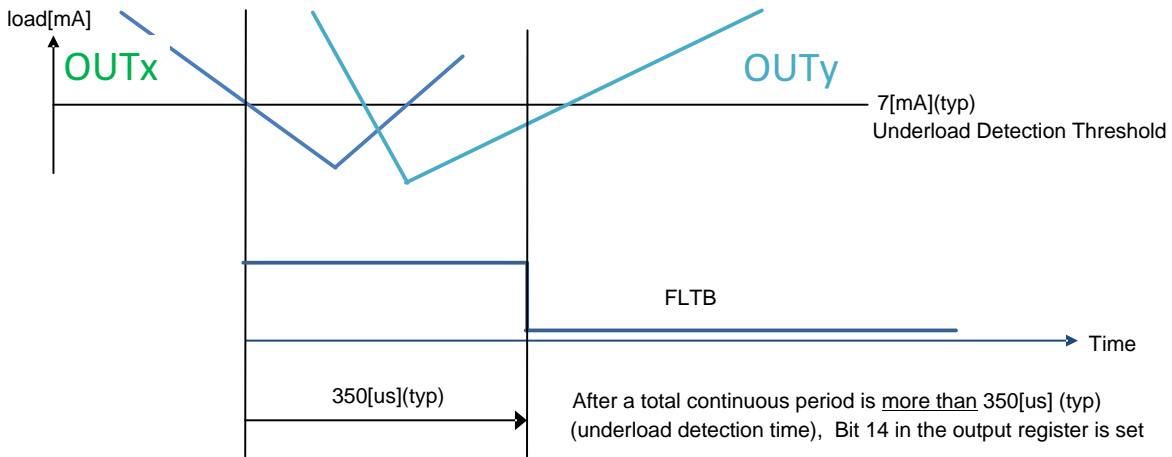

Figure 10. Underload Continuous Time

ENABLE

A single enable input (EN) provides on and off control for the two half-bridge outputs and activation of the fault reporting FLT pin. The EN input has a logic level input threshold. A high on EN enables both outputs (OUT1 & OUT2). The outputs will become active in the state which is represented by the respective input pins (IN1 & IN2).

Input Control

IN1 & IN2 are both logic level inputs which are active with EN high. A low on IN1 or IN2 with EN high activates the low-side drivers of OUT1 or OUT2. A high on IN1 or IN2 with EN high activates the high-side drivers of OUT1 or OUT2.

Fault Reporting

Fault reporting is carried out through the open-drain FLT pin. A pull-up resistor is required for operation. The FLT pin has a maximum voltage of 5.5 V. In normal operation, FLT reports a high signal. During a fault, the FLT pin will go low and stay low. FLT reporting is cleared by a toggle of the EN input or a power-on reset of VCC.

There are 3 faults reported by FLT

1. Underload
2. Overcurrent

Table 5. FAULT TABLE

Fault	FLT	Driver Condition During Fault	Driver Condition after Parameters Within Specified Limits	FLT Clear Requirement
No Fault	High	Output Driver on	Output Driver on	N/A
Underload (7 mA)	Low	unchanged	unchanged	EN toggle or VCC POR
Overcurrent	Low	Offending Driver is latched off after 25 μ s	Offending Driver is latched off	EN toggle or VCC POR
Thermal Shutdown	Low	All Drivers latched off at 175°C	All Drivers latched off	EN toggle or VCC POR

3. Thermal Shutdown

Undervoltage lockout and overvoltage lockout are **NOT** reported on FLT.

Thermal Shutdown

Thermal Shutdown uses one common sensor for each HS and LS transistor pair. If the IC temperature reaches Over Temperature Shutdown, all drivers are latched off and FLT will report a low. It can be reset only after the part cools below the shutdown temperature, including thermal hysteresis. The driver can be turned back on by a toggle of the EN pin or a power on reset of VCC.

Table 4. LOGIC TABLE

EN	IN1	IN2	OUT1	OUT2
0	0	0	Off	Off
0	0	1	Off	Off
0	1	0	Off	Off
0	1	1	Off	Off
1	0	0	Low	Low
1	0	1	Low	High
1	1	0	High	Low
1	1	1	High	High

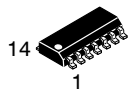

SCALE 1:1

SOIC-14 NB
CASE 751A-03
ISSUE L

DATE 03 FEB 2016

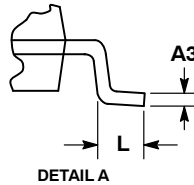
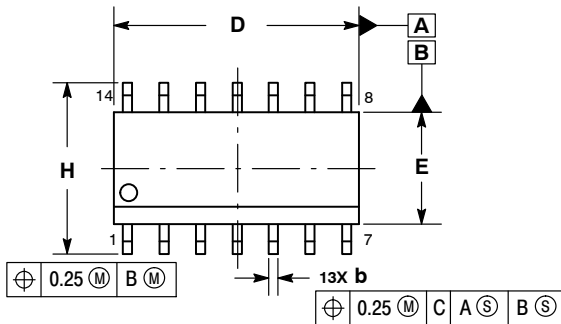

- NOTES:
1. DIMENSIONING AND TOLERANCING PER ASME Y14.5M, 1994.
 2. CONTROLLING DIMENSION: MILLIMETERS.
 3. DIMENSION b DOES NOT INCLUDE DAMBAR PROTRUSION. ALLOWABLE PROTRUSION SHALL BE 0.13 TOTAL IN EXCESS OF AT MAXIMUM MATERIAL CONDITION.
 4. DIMENSIONS D AND E DO NOT INCLUDE MOLD PROTRUSIONS.
 5. MAXIMUM MOLD PROTRUSION 0.15 PER SIDE.

DIM	MILLIMETERS		INCHES	
	MIN	MAX	MIN	MAX
A	1.35	1.75	0.054	0.068
A1	0.10	0.25	0.004	0.010
A3	0.19	0.25	0.008	0.010
b	0.35	0.49	0.014	0.019
D	8.55	8.75	0.337	0.344
E	3.80	4.00	0.150	0.157
e	1.27 BSC		0.050 BSC	
H	5.80	6.20	0.228	0.244
h	0.25	0.50	0.010	0.019
L	0.40	1.25	0.016	0.049
M	0°	7°	0°	7°

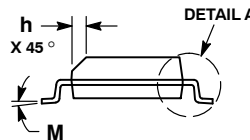
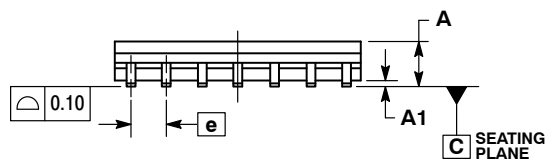

SOLDERING FOOTPRINT*

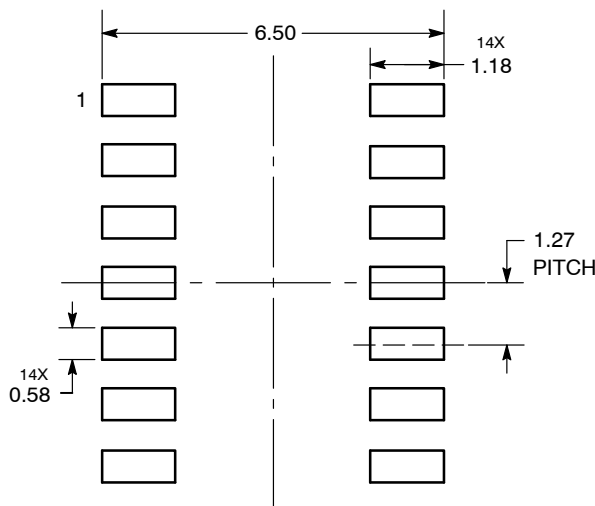

DIMENSIONS: MILLIMETERS

*For additional information on our Pb-Free strategy and soldering details, please download the onsemi Soldering and Mounting Techniques Reference Manual, SOLDERRM/D.

GENERIC MARKING DIAGRAM*

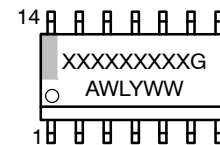

- XXXXXX = Specific Device Code
- A = Assembly Location
- WL = Wafer Lot
- Y = Year
- WW = Work Week
- G = Pb-Free Package

*This information is generic. Please refer to device data sheet for actual part marking. Pb-Free indicator, "G" or microdot "▪", may or may not be present. Some products may not follow the Generic Marking.

STYLES ON PAGE 2

DOCUMENT NUMBER:	98ASB42565B	Electronic versions are uncontrolled except when accessed directly from the Document Repository. Printed versions are uncontrolled except when stamped "CONTROLLED COPY" in red.
DESCRIPTION:	SOIC-14 NB	PAGE 1 OF 2

onsemi and onsemi are trademarks of Semiconductor Components Industries, LLC dba onsemi or its subsidiaries in the United States and/or other countries. onsemi reserves the right to make changes without further notice to any products herein. onsemi makes no warranty, representation or guarantee regarding the suitability of its products for any particular purpose, nor does onsemi assume any liability arising out of the application or use of any product or circuit, and specifically disclaims any and all liability, including without limitation special, consequential or incidental damages. onsemi does not convey any license under its patent rights nor the rights of others.

SOIC-14
CASE 751A-03
ISSUE L

DATE 03 FEB 2016

STYLE 1:
 PIN 1. COMMON CATHODE
 2. ANODE/CATHODE
 3. ANODE/CATHODE
 4. NO CONNECTION
 5. ANODE/CATHODE
 6. NO CONNECTION
 7. ANODE/CATHODE
 8. ANODE/CATHODE
 9. ANODE/CATHODE
 10. NO CONNECTION
 11. ANODE/CATHODE
 12. ANODE/CATHODE
 13. NO CONNECTION
 14. COMMON ANODE

STYLE 2:
 CANCELLED

STYLE 3:
 PIN 1. NO CONNECTION
 2. ANODE
 3. ANODE
 4. NO CONNECTION
 5. ANODE
 6. NO CONNECTION
 7. ANODE
 8. ANODE
 9. ANODE
 10. NO CONNECTION
 11. ANODE
 12. ANODE
 13. NO CONNECTION
 14. COMMON CATHODE

STYLE 4:
 PIN 1. NO CONNECTION
 2. CATHODE
 3. CATHODE
 4. NO CONNECTION
 5. CATHODE
 6. NO CONNECTION
 7. CATHODE
 8. CATHODE
 9. CATHODE
 10. NO CONNECTION
 11. CATHODE
 12. CATHODE
 13. NO CONNECTION
 14. COMMON ANODE

STYLE 5:
 PIN 1. COMMON CATHODE
 2. ANODE/CATHODE
 3. ANODE/CATHODE
 4. ANODE/CATHODE
 5. ANODE/CATHODE
 6. NO CONNECTION
 7. COMMON ANODE
 8. COMMON CATHODE
 9. ANODE/CATHODE
 10. ANODE/CATHODE
 11. ANODE/CATHODE
 12. ANODE/CATHODE
 13. NO CONNECTION
 14. COMMON ANODE

STYLE 6:
 PIN 1. CATHODE
 2. CATHODE
 3. CATHODE
 4. CATHODE
 5. CATHODE
 6. CATHODE
 7. CATHODE
 8. ANODE
 9. ANODE
 10. ANODE
 11. ANODE
 12. ANODE
 13. ANODE
 14. ANODE

STYLE 7:
 PIN 1. ANODE/CATHODE
 2. COMMON ANODE
 3. COMMON CATHODE
 4. ANODE/CATHODE
 5. ANODE/CATHODE
 6. ANODE/CATHODE
 7. ANODE/CATHODE
 8. ANODE/CATHODE
 9. ANODE/CATHODE
 10. ANODE/CATHODE
 11. COMMON CATHODE
 12. COMMON ANODE
 13. ANODE/CATHODE
 14. ANODE/CATHODE

STYLE 8:
 PIN 1. COMMON CATHODE
 2. ANODE/CATHODE
 3. ANODE/CATHODE
 4. NO CONNECTION
 5. ANODE/CATHODE
 6. ANODE/CATHODE
 7. COMMON ANODE
 8. COMMON ANODE
 9. ANODE/CATHODE
 10. ANODE/CATHODE
 11. NO CONNECTION
 12. ANODE/CATHODE
 13. ANODE/CATHODE
 14. COMMON CATHODE

DOCUMENT NUMBER:	98ASB42565B	Electronic versions are uncontrolled except when accessed directly from the Document Repository. Printed versions are uncontrolled except when stamped "CONTROLLED COPY" in red.
DESCRIPTION:	SOIC-14 NB	PAGE 2 OF 2

onsemi and **ONSEMI** are trademarks of Semiconductor Components Industries, LLC dba **onsemi** or its subsidiaries in the United States and/or other countries. **onsemi** reserves the right to make changes without further notice to any products herein. **onsemi** makes no warranty, representation or guarantee regarding the suitability of its products for any particular purpose, nor does **onsemi** assume any liability arising out of the application or use of any product or circuit, and specifically disclaims any and all liability, including without limitation special, consequential or incidental damages. **onsemi** does not convey any license under its patent rights nor the rights of others.

onsemi, **Onsemi**, and other names, marks, and brands are registered and/or common law trademarks of Semiconductor Components Industries, LLC dba "**onsemi**" or its affiliates and/or subsidiaries in the United States and/or other countries. **onsemi** owns the rights to a number of patents, trademarks, copyrights, trade secrets, and other intellectual property. A listing of **onsemi**'s product/patent coverage may be accessed at www.onsemi.com/site/pdf/Patent-Marking.pdf. **onsemi** reserves the right to make changes at any time to any products or information herein, without notice. The information herein is provided "as-is" and **onsemi** makes no warranty, representation or guarantee regarding the accuracy of the information, product features, availability, functionality, or suitability of its products for any particular purpose, nor does **onsemi** assume any liability arising out of the application or use of any product or circuit, and specifically disclaims any and all liability, including without limitation special, consequential or incidental damages. Buyer is responsible for its products and applications using **onsemi** products, including compliance with all laws, regulations and safety requirements or standards, regardless of any support or applications information provided by **onsemi**. "Typical" parameters which may be provided in **onsemi** data sheets and/or specifications can and do vary in different applications and actual performance may vary over time. All operating parameters, including "Typicals" must be validated for each customer application by customer's technical experts. **onsemi** does not convey any license under any of its intellectual property rights nor the rights of others. **onsemi** products are not designed, intended, or authorized for use as a critical component in life support systems or any FDA Class 3 medical devices or medical devices with a same or similar classification in a foreign jurisdiction or any devices intended for implantation in the human body. Should Buyer purchase or use **onsemi** products for any such unintended or unauthorized application, Buyer shall indemnify and hold **onsemi** and its officers, employees, subsidiaries, affiliates, and distributors harmless against all claims, costs, damages, and expenses, and reasonable attorney fees arising out of, directly or indirectly, any claim of personal injury or death associated with such unintended or unauthorized use, even if such claim alleges that **onsemi** was negligent regarding the design or manufacture of the part. **onsemi** is an Equal Opportunity/Affirmative Action Employer. This literature is subject to all applicable copyright laws and is not for resale in any manner.

ADDITIONAL INFORMATION

TECHNICAL PUBLICATIONS:

Technical Library: www.onsemi.com/design/resources/technical-documentation
onsemi Website: www.onsemi.com

ONLINE SUPPORT: www.onsemi.com/support

For additional information, please contact your local Sales Representative at www.onsemi.com/support/sales