

Single D Flip-Flop

NLX1G74

The NLX1G74 is a high performance, full function edge-triggered D Flip-Flop in ultra-small footprint. The NLX1G74 input structures provide protection when voltages up to 7.0 V are applied, regardless of the supply voltage.

Features

- Extremely High Speed: $t_{PD} = 2.6$ ns (typical) at $V_{CC} = 5.0$ V
- Designed for 1.65 V to 5.5 V V_{CC} Operation
- Low Power Dissipation: $I_{CC} = 1$ μ A (Max) at $T_A = 25^\circ$ C
- 24 mA Balanced Output Sink and Source Capability at $V_{CC} = 3.0$ V
- Balanced Propagation Delays
- Overvoltage Tolerant (OVT) Input Pins
- Ultra Small Package
- NLV Prefix for Automotive and Other Applications Requiring Unique Site and Control Change Requirements; AEC-Q100 Qualified and PPAP Capable
- This is a Pb-Free Device

TRUTH TABLE

Inputs				Outputs		Operating Mode
PR	CLR	CP	D	Q	\bar{Q}	
L	H	X	X	H	L	Asynchronous Set Asynchronous Clear Undetermined
H	L	X	X	L	H	
L	L	X	X	H	H	
H	H	\uparrow	h	H	L	Load and Read Register
H	H	\uparrow	l	L	H	
H	H	\uparrow	X	NC	NC	Hold

- H = High Voltage Level
 h = High Voltage Level One Setup Time Prior to the Low-to-High Clock Transition
 L = Low Voltage Level
 l = Low Voltage Level One Setup Time Prior to the Low-to-High Clock Transition
 NC = No Change
 X = High or Low Voltage Level and Transitions are Acceptable
 \uparrow = Low-to-High Transition
 \updownarrow = Not a Low-to-High Transition
 For I_{CC} reasons, DO NOT FLOAT Inputs



UQFN8
MU SUFFIX
CASE 523AN

MARKING DIAGRAM

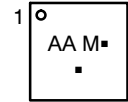

AA = Device Code
 M = Date Code*
 ■ = Pb-Free Package

(Note: Microdot may be in either location)

PINOUT DIAGRAM

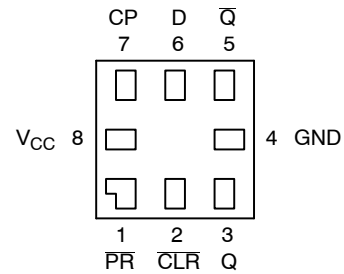

LOGIC DIAGRAM

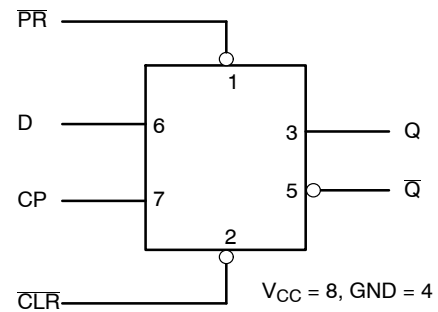

ORDERING INFORMATION

See detailed ordering and shipping information in the package dimensions section on page 3 of this data sheet.

NOTE: Some of the devices on this data sheet have been **DISCONTINUED**. Please refer to the table on page 3.

NLX1G74

MAXIMUM RATINGS

Symbol	Parameter	Value	Unit
V _{CC}	DC Supply Voltage	-0.5 to +7.0	V
V _I	DC Input Voltage	-0.5 to +7.0	V
V _O	DC Output Voltage – Output in High or Low State (Note 1)	-0.5 to V _{CC} +0.5	V
I _{IK}	DC Input Diode Current V _I < GND	-50	mA
I _{OK}	DC Output Diode Current V _O < GND	-50	mA
I _O	DC Output Sink Current	±50	mA
I _{CC}	DC Supply Current Per Supply Pin	±100	mA
I _{GND}	DC Ground Current Per Ground Pin	±100	mA
T _{STG}	Storage Temperature Range	-65 to +150	°C
T _L	Lead Temperature, 1 mm from Case for 10 Seconds	260	°C
T _J	Junction Temperature Under Bias	+150	°C
θ _{JA}	Thermal Resistance (Note 2)	250	°C/W
P _D	Power Dissipation in Still Air at 85°C	250	mW
MSL	Moisture Sensitivity	Level 1	
F _R	Flammability Rating Oxygen Index: 28 to 34	UL 94 V-0 @ 0.125 in	
V _{ESD}	ESD Withstand Voltage Human Body Model (Note 3) Machine Model (Note 4) Charged Device Model (Note 5)	>2000 >200 N/A	V

Stresses exceeding those listed in the Maximum Ratings table may damage the device. If any of these limits are exceeded, device functionality should not be assumed, damage may occur and reliability may be affected.

1. I_O absolute maximum rating must be observed.
2. Measured with minimum pad spacing on an FR4 board, using 10 mm X 1 inch, 2 ounce copper trace with no air flow.
3. Tested to EIA/JESD22-A114-A.
4. Tested to EIA/JESD22-A115-A.
5. Tested to JESD22-C101-A.

RECOMMENDED OPERATING CONDITIONS

Symbol	Parameter	Min	Max	Unit	
V _{CC}	Supply Voltage	Operating	1.65	5.5	V
		Data Retention Only	1.5	5.5	
V _I	Input Voltage (Note 6)	0	5.5	V	
V _O	Output Voltage (HIGH or LOW State)	0	V _{CC}	V	
T _A	Operating Free-Air Temperature	-40	+85	°C	
Δt/ΔV	Input Transition Rise or Fall Rate	V _{CC} = 2.5 V ±0.2 V	0	20	ns/V
		V _{CC} = 3.0 V ±0.3 V	0	10	
		V _{CC} = 5.0 V ±0.5 V	0	5.0	

6. Unused inputs may not be left open. All inputs must be tied to a high-logic voltage level or a low-logic input voltage level.

NLX1G74

ORDERING INFORMATION

Device	Package	Shipping†
NLX1G74MUTCG	UQFN8 (Pb-Free)	3000 / Tape & Reel

DISCONTINUED (Note 7)

NLVX1G74MUTCG*	UQFN8 (Pb-Free)	3000 / Tape & Reel
----------------	--------------------	--------------------

†For information on tape and reel specifications, including part orientation and tape sizes, please refer to our Tape and Reel Packaging Specifications Brochure, BRD8011/D.

*NLV Prefix for Automotive and Other Applications Requiring Unique Site and Control Change Requirements; AEC-Q100 Qualified and PPAP Capable.

7. **DISCONTINUED:** These devices are not recommended for new design. Please contact your **onsemi** representative for information. The most current information on these devices may be available on www.onsemi.com.

DC ELECTRICAL CHARACTERISTICS

Symbol	Parameter	Condition	V _{CC} (V)	T _A = 25°C			-40°C ≤ T _A ≤ 85°C		Unit
				Min	Typ	Max	Min	Max	
V _{IH}	High-Level Input Voltage		1.65	0.75 V _{CC}			0.75 V _{CC}		V
			2.3 to 5.5	0.7 V _{CC}			0.7 V _{CC}		
V _{IL}	Low-Level Input Voltage		1.65			0.25 V _{CC}		0.25 V _{CC}	V
			2.3 to 5.5			0.3 V _{CC}		0.3 V _{CC}	
V _{OH}	High-Level Output Voltage V _{IN} = V _{IL} or V _{IH}	I _{OH} = 100 μA	1.65 to 5.5	V _{CC} - 0.1	V _{CC}		V _{CC} - 0.1		V
		I _{OH} = -3 mA	1.65	1.29	1.52		1.29		
		I _{OH} = -8 mA	2.3	1.9	2.1		1.9		
		I _{OH} = -12 mA	2.7	2.2	2.4		2.2		
		I _{OH} = -16 mA	3.0	2.4	2.7		2.4		
		I _{OH} = -24 mA	3.0	2.3	2.5		2.3		
		I _{OH} = -32 mA	4.5	3.8	4.0		3.8		
V _{OL}	Low-Level Output Voltage V _{IN} = V _{IH}	I _{OL} = 100 μA	1.65 to 5.5		0.008	0.1		0.1	V
		I _{OL} = 3 mA	1.65		0.10	0.24		0.24	
		I _{OL} = 8 mA	2.3		0.12	0.3		0.3	
		I _{OL} = 12 mA	2.7		0.15	0.4		0.4	
		I _{OL} = 16 mA	3.0		0.19	0.4		0.4	
		I _{OL} = 24 mA	3.0		0.30	0.55		0.55	
		I _{OL} = 32 mA	4.5		0.30	0.55		0.55	
I _{IN}	Input Leakage Current	V _{IN} = V _{CC} or GND	5.5			±0.1		±1.0	μA
I _{OFF}	Power off Input Leakage Current	5.5V or V _{IN} = GND	0			1.0		10	μA
I _{CC}	Quiescent Supply Current	V _{IN} = V _{CC} or GND	5.5			1.0		10	μA

NLX1G74

AC ELECTRICAL CHARACTERISTICS (Input $t_r = t_f = 3.0$ ns)

Symbol	Parameter	V _{CC} (V)	Test Conditions	T _A = 25°C			T _A = -40 to 85°C		Unit
				Min	Typ	Max	Min	Max	
f _{MAX}	Maximum Clock Frequency (50% Duty Cycle) (Waveform 1)	1.8 ± 0.15	C _L = 15 pF R _D = 1 MΩ S ₁ = Open	75			75		MHz
		2.5 ± 0.2		150			150		
		3.3 ± 0.3		200			200		
		5.0 ± 0.5	250			250			
		3.3 ± 0.3	C _L = 50 pF, R _D = 500 Ω, S ₁ = Open	175			175		
		5.0 ± 0.5		200			200		
t _{PLH} , t _{PHL}	Propagation Delay, CP to Q or \bar{Q} (Waveform 1)	1.8 ± 0.15	C _L = 15 pF R _D = 1 MΩ S ₁ = Open	2.5	6.5	12.5	2.5	13	ns
		2.5 ± 0.2		1.5	3.8	7.5	1.5	8.0	
		3.3 ± 0.3		1.0	2.8	6.5	1.0	7.0	
		5.0 ± 0.5	0.8	2.2	4.5	0.8	5.0		
		3.3 ± 0.3	C _L = 50 pF, R _D = 500 Ω, S ₁ = Open	1.0	3.4	7.0	1.0	7.5	
		5.0 ± 0.5		1.0	2.6	5.0	1.0	5.5	
t _{PLH} , t _{PHL}	Propagation Delay, PR or CLR to Q or \bar{Q} (Waveform 2)	1.8 ± 0.15	C _L = 15 pF R _D = 1 MΩ S ₁ = Open	2.5	6.5	14	2.5	14.5	ns
		2.5 ± 0.2		1.5	3.8	9.0	1.5	9.5	
		3.3 ± 0.3		1.0	2.8	6.5	1.0	7.0	
		5.0 ± 0.5	0.8	2.2	5.0	0.8	5.5		
		3.3 ± 0.3	C _L = 50 pF, R _D = 500 Ω, S ₁ = Open	1.0	3.4	7.0	1.0	7.5	
		5.0 ± 0.5		1.0	2.6	5.0	1.0	5.5	
t _S	Setup Time, D to CP (Waveform 1)	1.8 ± 0.15	C _L = 15 pF R _D = 1 MΩ S ₁ = Open	6.5			6.5		ns
		2.5 ± 0.2		3.5			3.5		
		3.3 ± 0.3		2.0			2.0		
		5.0 ± 0.5	1.5			1.5			
		3.3 ± 0.3	C _L = 50 pF, R _D = 500 Ω, S ₁ = Open	2.0			2.0		
		5.0 ± 0.5		1.5			1.5		
t _H	Hold Time, D to CP (Waveform 1)	1.8 ± 0.15	C _L = 15 pF R _D = 1 MΩ S ₁ = Open	0.5			0.5		ns
		2.5 ± 0.2		0.5			0.5		
		3.3 ± 0.3		0.5			0.5		
		5.0 ± 0.5	0.5			0.5			
		3.3 ± 0.3	C _L = 50 pF, R _D = 500 Ω, S ₁ = Open	0.5			0.5		
		5.0 ± 0.5		0.5			0.5		
t _W	Pulse Width, CP, CLR, PR (Waveform 3)	1.8 ± 0.15	C _L = 15 pF R _D = 1 MΩ S ₁ = Open	6.0			6.0		ns
		2.5 ± 0.2		4.0			4.0		
		3.3 ± 0.3		3.0			3.0		
		5.0 ± 0.5	2.0			2.0			
		3.3 ± 0.3	C _L = 50 pF, R _D = 500 Ω, S ₁ = Open	3.0			3.0		
		5.0 ± 0.5		2.0			2.0		
t _{REC}	Recover Time PR; CLR to CP (Waveform 3)	1.8 ± 0.15	C _L = 15 pF R _D = 1 MΩ S ₁ = Open	8.0			8.0		MHz
		2.5 ± 0.2		4.5			4.5		
		3.3 ± 0.3		3.0			3.0		
		5.0 ± 0.5	3.0			3.0			
		3.3 ± 0.3	C _L = 50 pF, R _D = 500 Ω, S ₁ = Open	3.0			3.0		
		5.0 ± 0.5		3.0			3.0		

8. C_{PD} is defined as the value of the internal equivalent capacitance which is calculated from the operating current consumption without load. Average operating current can be obtained by the equation: I_{CC(OPR)} = C_{PD} • V_{CC} • f_{in} + I_{CC}/2 (per flip-flop). C_{PD} is used to determine the no-load dynamic power consumption; P_D = C_{PD} • V_{CC}² • f_{in} + I_{CC} • V_{CC}.

CAPACITANCE (Note 9)

Symbol	Parameter	Condition	Typical	Unit
C _{IN}	Input Capacitance	V _{CC} = 5.5 V	7.0	pF
C _{OUT}	Output Capacitance	V _{CC} = 5.5 V	7.0	pF
C _{PD}	Power Dissipation Capacitance (Note 10) Frequency = 10 MHz	V _{CC} = 3.3 V	16	pF
		V _{CC} = 5.0 V	21	

9. T_A = +25°C, f = 1 MHz

10. C_{PD} is defined as the value of the internal equivalent capacitance which is derived from dynamic operating current consumption (I_{CCD}) at no output loading and operating at 50% duty cycle. (See Figure 1) C_{PD} is related to I_{CCD} dynamic operating current by the expression:
I_{CCD} = C_{PD} • V_{CC} • f_{in} + I_{CC(static)}.

NLX1G74

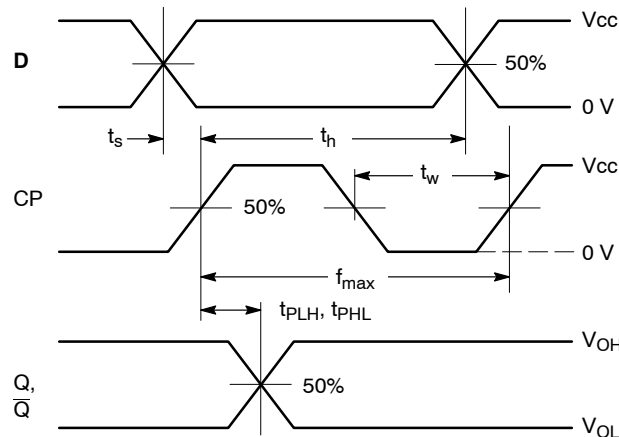

WAVEFORM 1 - PROPAGATION DELAYS, SETUP AND HOLD TIMES

$t_R = t_F = 3.0$ ns, 10% to 90%; $f = 1$ MHz; $t_W = 500$ ns

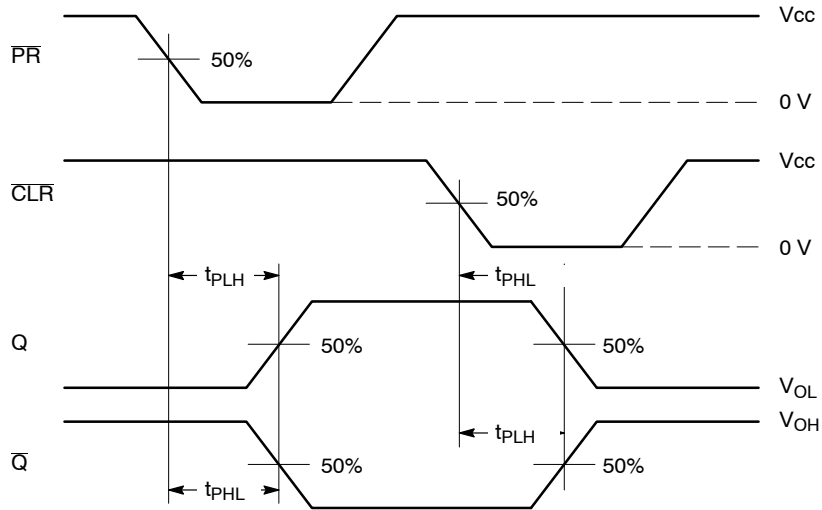

WAVEFORM 2 - PROPAGATION DELAYS

$t_R = t_F = 3.0$ ns, 10% to 90%; $f = 1$ MHz; $t_W = 500$ ns

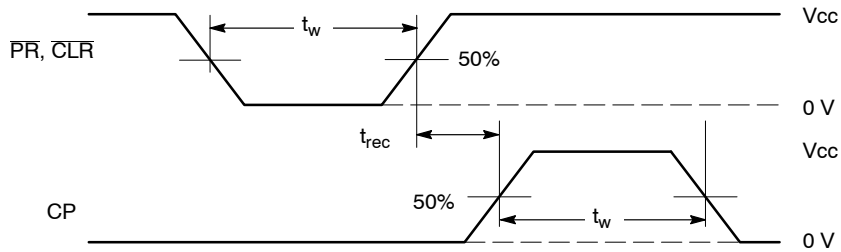

WAVEFORM 3 - RECOVERY TIME

$t_R = t_F = 3.0$ ns from 10% to 90%; $f = 1$ MHz; $t_W = 500$ ns

Output Reg: $V_{OL} \leq 0.8$ V, $V_{OH} \geq 2.0$ V

Figure 1. AC Waveforms

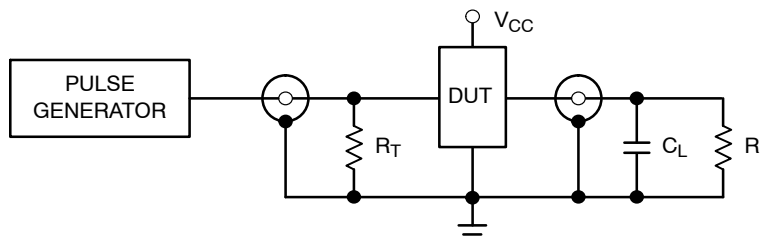

Figure 2. Test Circuit

MECHANICAL CASE OUTLINE

PACKAGE DIMENSIONS



SCALE 4:1

UQFN8, 1.60x1.60, 0.50P
CASE 523AN
ISSUE O

DATE 26 NOV 2008

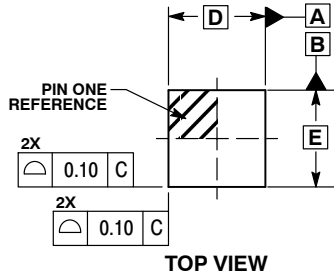

TOP VIEW

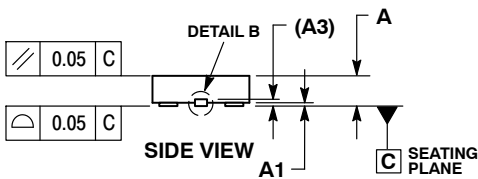

SIDE VIEW

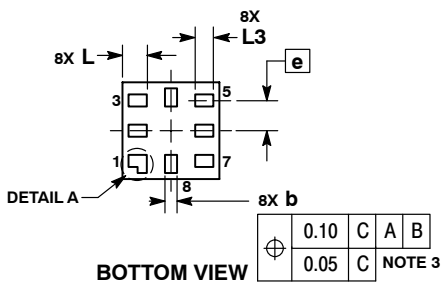

BOTTOM VIEW

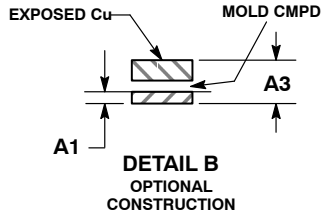

DETAIL B
OPTIONAL
CONSTRUCTION

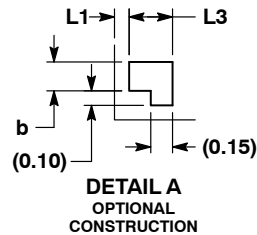

DETAIL A
OPTIONAL
CONSTRUCTION

NOTES:

1. DIMENSIONING AND TOLERANCING PER ASME Y14.5M, 1994.
2. CONTROLLING DIMENSION: MILLIMETERS.
3. DIMENSION b APPLIES TO PLATED TERMINAL AND IS MEASURED BETWEEN 0.15 AND 0.30 mm FROM THE TERMINAL TIP.

MILLIMETERS		
DIM	MIN	MAX
A	0.45	0.60
A1	0.00	0.05
A3	0.13	REF
b	0.15	0.25
D	1.60	BSC
E	1.60	BSC
e	0.50	BSC
L	0.35	0.45
L1	---	0.15
L3	0.25	0.35

SOLDERING FOOTPRINT*

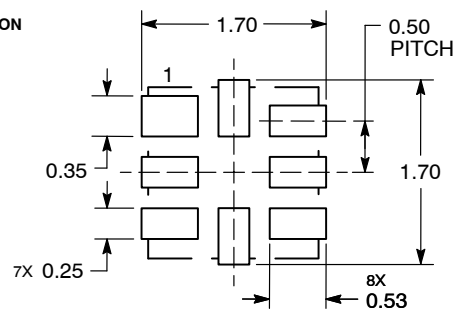

DIMENSIONS: MILLIMETERS

*For additional information on our Pb-Free strategy and soldering details, please download the onsemi Soldering and Mounting Techniques Reference Manual, SOLDERRM/D.

GENERIC MARKING DIAGRAM*

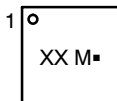

- XX = Specific Device Code
- M = Date Code
- = Pb-Free Package

*This information is generic. Please refer to device data sheet for actual part marking. Pb-Free indicator, "G" or microdot "▪", may or may not be present. Some products may not follow the Generic Marking.

DOCUMENT NUMBER:	98AON36348E	Electronic versions are uncontrolled except when accessed directly from the Document Repository. Printed versions are uncontrolled except when stamped "CONTROLLED COPY" in red.
DESCRIPTION:	UQFN8, 1.60X1.60, 0.50P	PAGE 1 OF 1

onsemi and onsemi are trademarks of Semiconductor Components Industries, LLC dba onsemi or its subsidiaries in the United States and/or other countries. onsemi reserves the right to make changes without further notice to any products herein. onsemi makes no warranty, representation or guarantee regarding the suitability of its products for any particular purpose, nor does onsemi assume any liability arising out of the application or use of any product or circuit, and specifically disclaims any and all liability, including without limitation special, consequential or incidental damages. onsemi does not convey any license under its patent rights nor the rights of others.

onsemi, **Onsemi**, and other names, marks, and brands are registered and/or common law trademarks of Semiconductor Components Industries, LLC dba "**onsemi**" or its affiliates and/or subsidiaries in the United States and/or other countries. **onsemi** owns the rights to a number of patents, trademarks, copyrights, trade secrets, and other intellectual property. A listing of **onsemi**'s product/patent coverage may be accessed at www.onsemi.com/site/pdf/Patent-Marking.pdf. **onsemi** reserves the right to make changes at any time to any products or information herein, without notice. The information herein is provided "as-is" and **onsemi** makes no warranty, representation or guarantee regarding the accuracy of the information, product features, availability, functionality, or suitability of its products for any particular purpose, nor does **onsemi** assume any liability arising out of the application or use of any product or circuit, and specifically disclaims any and all liability, including without limitation special, consequential or incidental damages. Buyer is responsible for its products and applications using **onsemi** products, including compliance with all laws, regulations and safety requirements or standards, regardless of any support or applications information provided by **onsemi**. "Typical" parameters which may be provided in **onsemi** data sheets and/or specifications can and do vary in different applications and actual performance may vary over time. All operating parameters, including "Typicals" must be validated for each customer application by customer's technical experts. **onsemi** does not convey any license under any of its intellectual property rights nor the rights of others. **onsemi** products are not designed, intended, or authorized for use as a critical component in life support systems or any FDA Class 3 medical devices or medical devices with a same or similar classification in a foreign jurisdiction or any devices intended for implantation in the human body. Should Buyer purchase or use **onsemi** products for any such unintended or unauthorized application, Buyer shall indemnify and hold **onsemi** and its officers, employees, subsidiaries, affiliates, and distributors harmless against all claims, costs, damages, and expenses, and reasonable attorney fees arising out of, directly or indirectly, any claim of personal injury or death associated with such unintended or unauthorized use, even if such claim alleges that **onsemi** was negligent regarding the design or manufacture of the part. **onsemi** is an Equal Opportunity/Affirmative Action Employer. This literature is subject to all applicable copyright laws and is not for resale in any manner.

ADDITIONAL INFORMATION

TECHNICAL PUBLICATIONS:

Technical Library: www.onsemi.com/design/resources/technical-documentation
onsemi Website: www.onsemi.com

ONLINE SUPPORT: www.onsemi.com/support

For additional information, please contact your local Sales Representative at www.onsemi.com/support/sales