

# MOSFET – Power, Single, P-Channel with ESD Protection, SOT-723

**-20 V, -780 mA**

## NTK3139P

### Features

- P-channel Switch with Low  $R_{DS(on)}$
- 44% Smaller Footprint and 38% Thinner than SC-89
- Low Threshold Levels Allowing 1.5 V  $R_{DS(on)}$  Rating
- Operated at Low Logic Level Gate Drive
- These Devices are Pb-Free, Halogen Free/BFR Free and are RoHS Compliant

### Applications

- Load/Power Switching
- Interfacing, Logic Switching
- Battery Management for Ultra Small Portable Electronics

### MAXIMUM RATINGS ( $T_J = 25^\circ\text{C}$ unless otherwise stated)

Parameter			Symbol	Value	Unit
Drain-to-Source Voltage			$V_{DSS}$	-20	V
Gate-to-Source Voltage			$V_{GS}$	$\pm 6$	V
Continuous Drain Current (Note 1)	Steady State	$T_A = 25^\circ\text{C}$	$I_D$	-780	mA
		$T_A = 85^\circ\text{C}$		-570	
	$t \leq 5 \text{ s}$	$T_A = 25^\circ\text{C}$		-870	
Power Dissipation (Note 1)	Steady State	$T_A = 25^\circ\text{C}$	$P_D$	450	mW
	$t \leq 5 \text{ s}$			550	
Continuous Drain Current (Note 2)	Steady State	$T_A = 25^\circ\text{C}$	$I_D$	-660	mA
		$T_A = 85^\circ\text{C}$		-480	
Power Dissipation (Note 2)		$T_A = 25^\circ\text{C}$	$P_D$	310	mW
Pulsed Drain Current	$t_p = 10 \mu\text{s}$		$I_{DM}$	-1.2	A
Operating Junction and Storage Temperature			$T_J, T_{STG}$	-55 to 150	$^\circ\text{C}$
Lead Temperature for Soldering Purposes (1/8" from case for 10 s)			$T_L$	260	$^\circ\text{C}$

Stresses exceeding those listed in the Maximum Ratings table may damage the device. If any of these limits are exceeded, device functionality should not be assumed, damage may occur and reliability may be affected.

1. Surface mounted on FR4 board using 1 in sq pad size (Cu area = 1.127 in sq [1 oz] including traces)
2. Surface mounted on FR4 board using the minimum recommended pad size

$V_{(BR)DSS}$	$R_{DS(on)}$ TYP	$I_D$ Max
-20 V	0.38 $\Omega$ @ -4.5 V	-780 mA
	0.52 $\Omega$ @ -2.5 V	-660 mA
	0.70 $\Omega$ @ -1.8 V	-100 mA
	0.95 $\Omega$ @ -1.5 V	-100 mA

### SOT-723 (3-LEAD)

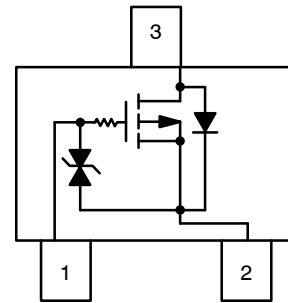

Top View

1 – Gate  
2 – Source  
3 – Drain

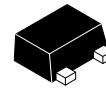

SOT-723  
CASE 631AA  
STYLE 5

### MARKING DIAGRAM

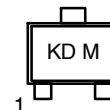

KD = Specific Device Code  
M = Date Code

### ORDERING INFORMATION

Device	Package	Shipping†
NTK3139PT1G	SOT-723 Pb-Free	4000 / Tape & Reel
NTK3139PT5G		8000 / Tape & Reel
NTK3139PT3G		40000 / Tape & Reel

†For information on tape and reel specifications, including part orientation and tape sizes, please refer to our Tape and Reel Packaging Specification Brochure, BRD8011/D.

# NTK3139P

## THERMAL RESISTANCE RATINGS

Parameter	Symbol	Max	Unit
Junction-to-Ambient – Steady State (Note 3)	$R_{\theta JA}$	280	°C/W
Junction-to-Ambient – $t = 5$ s (Note 3)	$R_{\theta JA}$	228	
Junction-to-Ambient – Steady State Minimum Pad (Note 4)	$R_{\theta JA}$	400	

3. Surface mounted on FR4 board using 1 in sq pad size (Cu area = 1.127 in sq [1 oz] including traces)  
 4. Surface mounted on FR4 board using the minimum recommended pad size

## MOSFET ELECTRICAL CHARACTERISTICS ( $T_J = 25^\circ\text{C}$ unless otherwise specified)

Parameter	Symbol	Test Condition	Min	Typ	Max	Unit
-----------	--------	----------------	-----	-----	-----	------

### OFF CHARACTERISTICS

Drain-to-Source Breakdown Voltage	$V_{(BR)DSS}$	$V_{GS} = 0$ V, $I_D = -250$ $\mu$ A	-20			V
Drain-to-Source Breakdown Voltage Temperature Coefficient	$V_{(BR)DSS}/T_J$	$I_D = -250$ $\mu$ A, Reference to $25^\circ\text{C}$		-16.5		mV/°C
Zero Gate Voltage Drain Current	$I_{DSS}$	$V_{GS} = 0$ V, $V_{DS} = -16$ V	$T_J = 25^\circ\text{C}$		-1.0	$\mu$ A
			$T_J = 125^\circ\text{C}$		-2.0	
Gate-to-Source Leakage Current	$I_{GSS}$	$V_{DS} = 0$ V, $V_{GS} = \pm 4.5$ V			$\pm 2.0$	$\mu$ A

### ON CHARACTERISTICS (Note 5)

Gate Threshold Voltage	$V_{GS(TH)}$	$V_{GS} = V_{DS}$ , $I_D = -250$ $\mu$ A	-0.45		-1.2	V
Negative Threshold Temperature Coefficient	$V_{GS(TH)}/T_J$			2.4		mV/°C
Drain-to-Source On Resistance	$R_{DS(on)}$	$V_{GS} = -4.5$ V, $I_D = -780$ mA		0.38	0.48	$\Omega$
		$V_{GS} = -2.5$ V, $I_D = -660$ mA		0.52	0.67	
		$V_{GS} = -1.8$ V, $I_D = -100$ mA		0.70	0.95	
		$V_{GS} = -1.5$ V, $I_D = -100$ mA		0.95	2.20	
Forward Transconductance	$g_{FS}$	$V_{DS} = -10$ V, $I_D = -540$ mA		1.2		S
Gate Resistance	$R_G$	$T_A = 25^\circ\text{C}$		112		$\Omega$

### CHARGES, CAPACITANCES AND GATE RESISTANCE

Input Capacitance	$C_{ISS}$	$V_{GS} = 0$ V, $f = 1$ MHz, $V_{DS} = -16$ V		113	170	$\mu$ F
Output Capacitance	$C_{OSS}$			15	25	
Reverse Transfer Capacitance	$C_{RSS}$			9.0	15	

### SWITCHING CHARACTERISTICS, $V_{GS} = 4.5$ V (Note 6)

Turn On Delay Time	$t_{d(ON)}$	$V_{GS} = -4.5$ V, $V_{DS} = -10$ V, $I_D = -200$ mA, $R_G = 10$ $\Omega$		9.0		ns
Rise Time	$t_r$			5.8		
TurnOff Delay Time	$t_{d(OFF)}$			32.7		
Fall Time	$t_f$			20.3		

### DRAIN SOURCE DIODE CHARACTERISTICS

Forward Diode Voltage	$V_{SD}$	$V_{GS} = 0$ V, $I_S = -350$ mA	$T_J = 25^\circ\text{C}$		-0.8	-1.2	V
Reverse Recovery Time	$t_{RR}$	$V_{GS} = 0$ V, $dI_{SD}/dt = 100$ A/ $\mu$ s, $I_S = -1.0$ A, $V_{DD} = -20$ V			13.2		ns
Charge Time	$t_a$				11.8		
Discharge Time	$t_b$				1.4		
Reverse Recovery Charge	$Q_{RR}$					5.0	

5. Pulse Test: pulse width = 300  $\mu$ s, duty cycle = 2%  
 6. Switching characteristics are independent of operating junction temperatures

TYPICAL CHARACTERISTICS

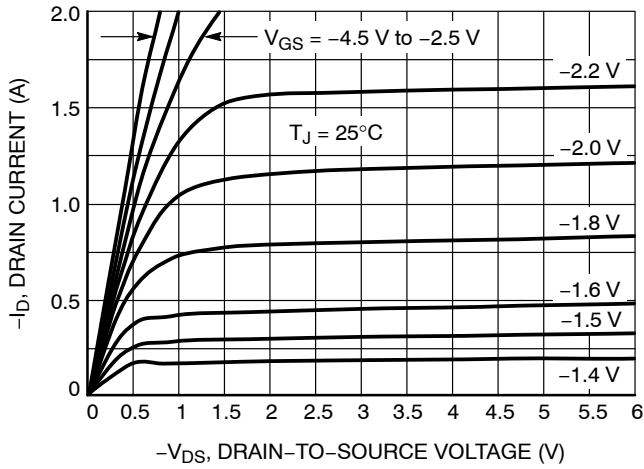

Figure 1. On-Region Characteristics

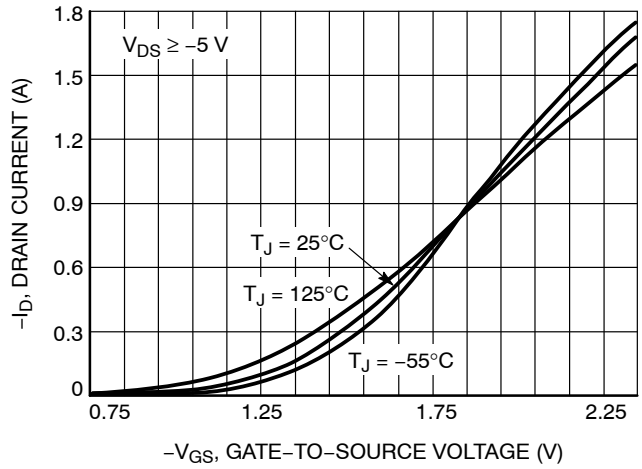

Figure 2. Transfer Characteristics

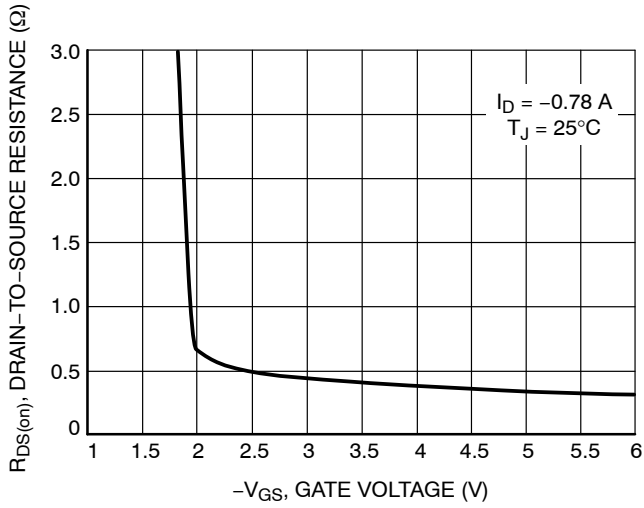

Figure 3. On-Resistance vs. Gate-to-Source Voltage

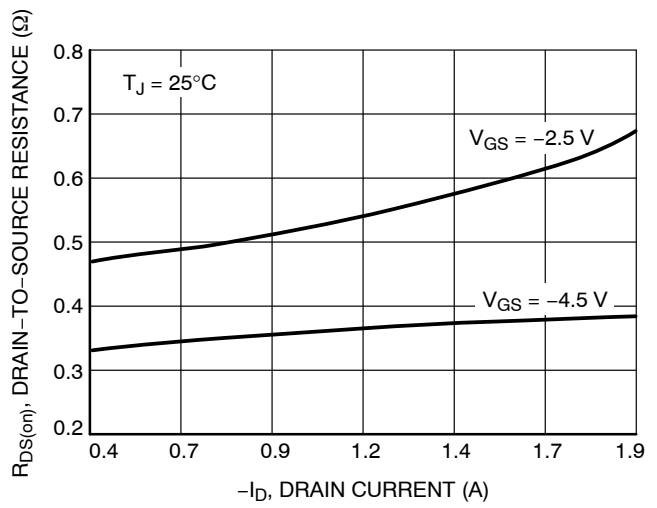

Figure 4. On-Resistance vs. Drain Current and Gate Voltage

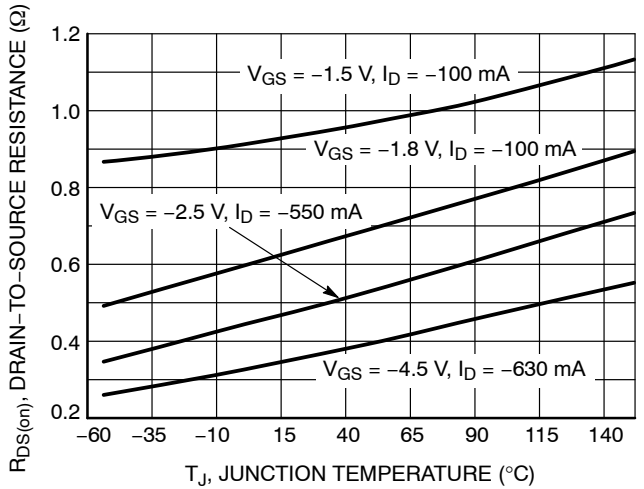

Figure 5. On-Resistance Variation with Temperature

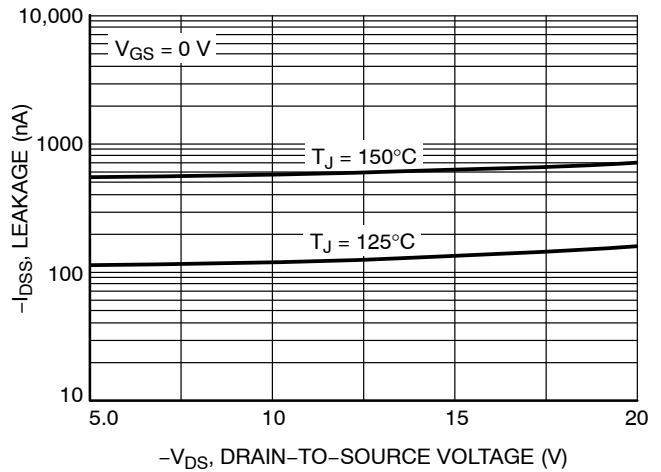

Figure 6. Drain-to-Source Leakage Current vs. Voltage

TYPICAL CHARACTERISTICS

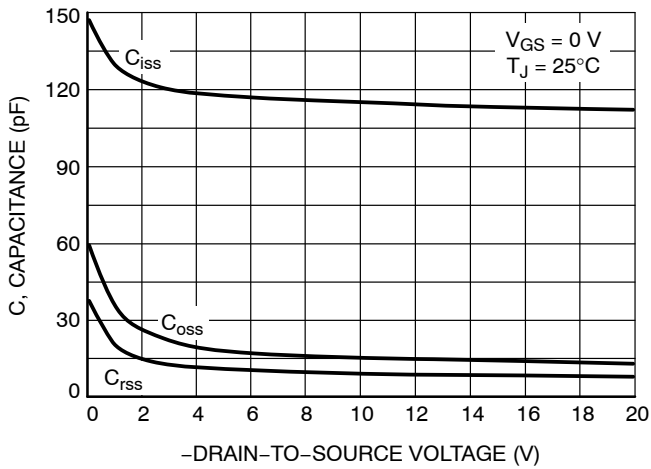

Figure 7. Capacitance Variation

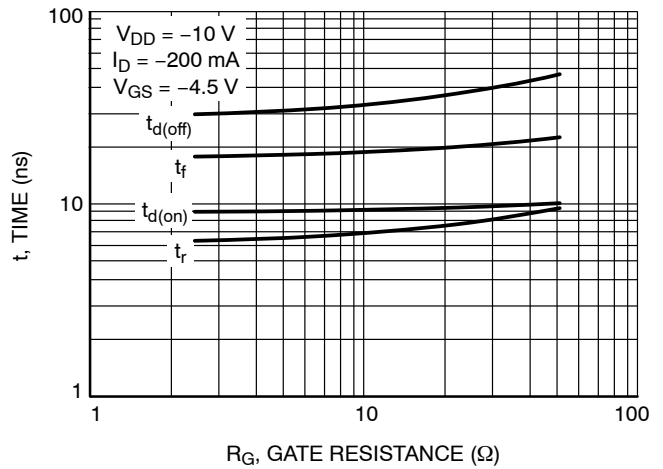

Figure 8. Resistive Switching Time Variation vs. Gate Resistance

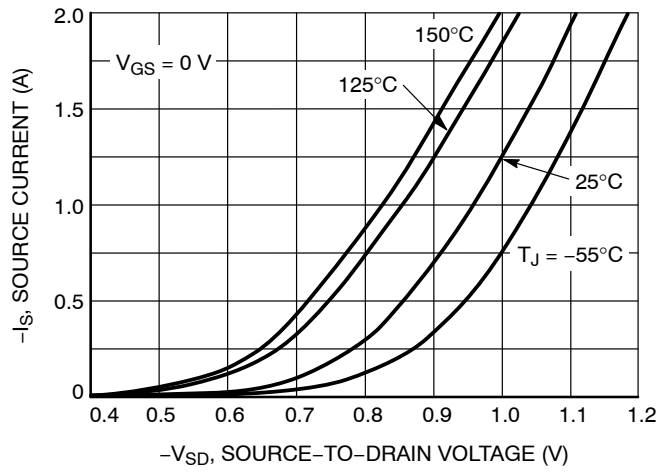

Figure 9. Diode Forward Voltage vs. Current

# MECHANICAL CASE OUTLINE

## PACKAGE DIMENSIONS



**SOT-723 1.20x0.80x0.50, 0.40P**  
**CASE 631AA**  
**ISSUE E**

DATE 24 JAN 2024

**NOTES:**

1. DIMENSIONING AND TOLERANCING PER ASME Y14.5M, 2018.
2. CONTROLLING DIMENSION: MILLIMETERS.
3. MAXIMUM LEAD THICKNESS INCLUDES LEAD FINISH. MINIMUM LEAD THICKNESS IS THE MINIMUM THICKNESS OF BASE MATERIAL.
4. DIMENSIONS D AND E DO NOT INCLUDE MOLD FLASH, PROTRUSIONS OR GATE BURRS.

DIM	MILLIMETERS		
	MIN.	NOM.	MAX.
A	0.45	0.50	0.55
b	0.15	0.21	0.27
b1	0.25	0.31	0.37
c	0.07	0.12	0.17
D	1.15	1.20	1.25
E	0.75	0.80	0.85
e	0.40 BSC		
H	1.15	1.20	1.25
L	0.29 REF		
L2	0.15	0.20	0.25



TOP VIEW



SIDE VIEW

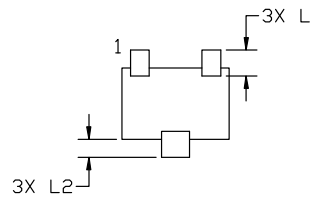

BOTTOM VIEW

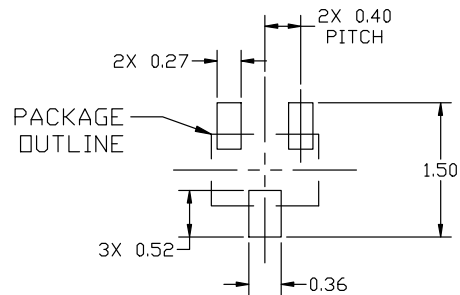

RECOMMENDED MOUNTING FOOTPRINT

**GENERIC MARKING DIAGRAM\***



XX = Specific Device Code  
M = Date Code

\*This information is generic. Please refer to device data sheet for actual part marking. Pb-Free indicator, "G" or microdot "•", may or may not be present. Some products may not follow the Generic Marking.

\*For additional information on our Pb-Free strategy and soldering details, please download the ON Semiconductor Soldering and Mounting Techniques Reference Manual, SOLDERRM/D.

STYLE 1:	STYLE 2:	STYLE 3:	STYLE 4:	STYLE 5:
PIN 1. BASE	PIN 1. ANODE	PIN 1. ANODE	PIN 1. CATHODE	PIN 1. GATE
2. EMITTER	2. N/C	2. ANODE	2. CATHODE	2. SOURCE
3. COLLECTOR	3. CATHODE	3. CATHODE	3. ANODE	3. DRAIN

<b>DOCUMENT NUMBER:</b>	<b>98AON12989D</b>	Electronic versions are uncontrolled except when accessed directly from the Document Repository. Printed versions are uncontrolled except when stamped "CONTROLLED COPY" in red.
<b>DESCRIPTION:</b>	<b>SOT-723 1.20x0.80x0.50, 0.40P</b>	<b>PAGE 1 OF 1</b>

onsemi and ONSEMI are trademarks of Semiconductor Components Industries, LLC dba onsemi or its subsidiaries in the United States and/or other countries. onsemi reserves the right to make changes without further notice to any products herein. onsemi makes no warranty, representation or guarantee regarding the suitability of its products for any particular purpose, nor does onsemi assume any liability arising out of the application or use of any product or circuit, and specifically disclaims any and all liability, including without limitation special, consequential or incidental damages. onsemi does not convey any license under its patent rights nor the rights of others.

**onsemi**, **Onsemi**, and other names, marks, and brands are registered and/or common law trademarks of Semiconductor Components Industries, LLC dba "**onsemi**" or its affiliates and/or subsidiaries in the United States and/or other countries. **onsemi** owns the rights to a number of patents, trademarks, copyrights, trade secrets, and other intellectual property. A listing of **onsemi**'s product/patent coverage may be accessed at [www.onsemi.com/site/pdf/Patent-Marking.pdf](http://www.onsemi.com/site/pdf/Patent-Marking.pdf). **onsemi** reserves the right to make changes at any time to any products or information herein, without notice. The information herein is provided "as-is" and **onsemi** makes no warranty, representation or guarantee regarding the accuracy of the information, product features, availability, functionality, or suitability of its products for any particular purpose, nor does **onsemi** assume any liability arising out of the application or use of any product or circuit, and specifically disclaims any and all liability, including without limitation special, consequential or incidental damages. Buyer is responsible for its products and applications using **onsemi** products, including compliance with all laws, regulations and safety requirements or standards, regardless of any support or applications information provided by **onsemi**. "Typical" parameters which may be provided in **onsemi** data sheets and/or specifications can and do vary in different applications and actual performance may vary over time. All operating parameters, including "Typicals" must be validated for each customer application by customer's technical experts. **onsemi** does not convey any license under any of its intellectual property rights nor the rights of others. **onsemi** products are not designed, intended, or authorized for use as a critical component in life support systems or any FDA Class 3 medical devices or medical devices with a same or similar classification in a foreign jurisdiction or any devices intended for implantation in the human body. Should Buyer purchase or use **onsemi** products for any such unintended or unauthorized application, Buyer shall indemnify and hold **onsemi** and its officers, employees, subsidiaries, affiliates, and distributors harmless against all claims, costs, damages, and expenses, and reasonable attorney fees arising out of, directly or indirectly, any claim of personal injury or death associated with such unintended or unauthorized use, even if such claim alleges that **onsemi** was negligent regarding the design or manufacture of the part. **onsemi** is an Equal Opportunity/Affirmative Action Employer. This literature is subject to all applicable copyright laws and is not for resale in any manner.

## ADDITIONAL INFORMATION

### TECHNICAL PUBLICATIONS:

Technical Library: [www.onsemi.com/design/resources/technical-documentation](http://www.onsemi.com/design/resources/technical-documentation)  
onsemi Website: [www.onsemi.com](http://www.onsemi.com)

### ONLINE SUPPORT: [www.onsemi.com/support](http://www.onsemi.com/support)

For additional information, please contact your local Sales Representative at [www.onsemi.com/support/sales](http://www.onsemi.com/support/sales)

