

# NTLGD3502N

## MOSFET – Power, Dual, N-Channel, DFN6 3X3 mm 20 V, 5.8 A/4.6 A



ON Semiconductor®

<http://onsemi.com>

### Features

- Exposed Drain Package
- Excellent Thermal Resistance for Superior Heat Dissipation
- Low Threshold Levels
- Low Profile (< 1 mm) Allows It to Fit Easily into Extremely Thin Environments
- This is a Pb-Free Device

### Applications

- DC-DC Converters (Buck and Boost Circuits)
- Power Supplies
- Hard Disk Drives

#### MOSFET I MAXIMUM RATINGS (T<sub>J</sub> = 25°C unless otherwise noted)

Parameter	Symbol	Value	Unit		
Drain-to-Source Voltage	V <sub>DSS</sub>	20	V		
Gate-to-Source Voltage	V <sub>GS</sub>	±20	V		
Continuous Drain Current (Note 1)	Steady State	T <sub>A</sub> = 25°C	4.3	A	
		T <sub>A</sub> = 85°C	3.0		
	t ≤ 5.0 s	T <sub>A</sub> = 25°C	5.8		
Power Dissipation (Note 1)	Steady State	T <sub>A</sub> = 25°C	P <sub>D</sub>	1.74	W
Pulsed Drain Current	t ≤ 10 μs	I <sub>DM</sub>	17.2	A	
Operating Junction and Storage Temperature	T <sub>J</sub> , T <sub>STG</sub>	-55 to 150	°C		
Source Current (Body Diode)	I <sub>S</sub>	1.6	A		
Lead Temperature for Soldering Purposes (1/8" from case for 10 s)	T <sub>L</sub>	260	°C		

#### MOSFET II MAXIMUM RATINGS (T<sub>J</sub> = 25°C unless otherwise noted)

Parameter	Symbol	Value	Unit		
Drain-to-Source Voltage	V <sub>DSS</sub>	20	V		
Gate-to-Source Voltage	V <sub>GS</sub>	±12	V		
Continuous Drain Current (Note 1)	Steady State	T <sub>A</sub> = 25°C	3.6	A	
		T <sub>A</sub> = 85°C	2.5		
	t ≤ 5.0 s	T <sub>A</sub> = 25°C	4.6		
Power Dissipation (Note 1)	Steady State	T <sub>A</sub> = 25°C	P <sub>D</sub>	1.74	W
Pulsed Drain Current	t ≤ 10 μs	I <sub>DM</sub>	13.8	A	
Operating Junction and Storage Temperature	T <sub>J</sub> , T <sub>STG</sub>	-55 to 150	°C		
Source Current (Body Diode)	I <sub>S</sub>	1.7	A		
Lead Temperature for Soldering Purposes (1/8" from case for 10 s)	T <sub>L</sub>	260	°C		

Stresses exceeding Maximum Ratings may damage the device. Maximum Ratings are stress ratings only. Functional operation above the Recommended Operating Conditions is not implied. Extended exposure to stresses above the Recommended Operating Conditions may affect device reliability.

1. Surface Mounted on FR4 Board using 1 in sq pad size (Cu area = 1.127 in sq [1 oz] including traces)

ON

### MOSFET I

V <sub>(BR)DSS</sub>	R <sub>DS(on)</sub> MAX	I <sub>D</sub> MAX
20 V	60 mΩ @ 4.5 V	5.8 A

### MOSFET II

V <sub>(BR)DSS</sub>	R <sub>DS(on)</sub> MAX	I <sub>D</sub> MAX
20 V	90 mΩ @ 4.5 V	4.6 A

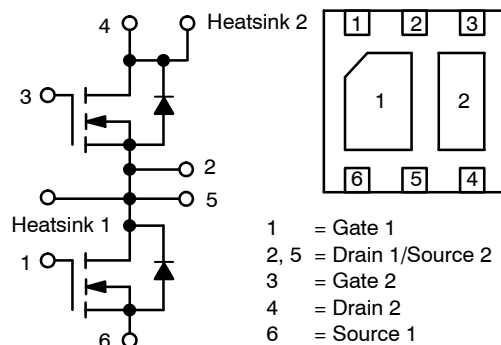

### MARKING DIAGRAMS



DFN6  
CASE 506AG

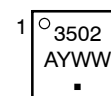

- 3502 = Specific Device Code
- A = Assembly Location
- Y = Year
- WW = Work Week
- = Pb-Free Package

### ORDERING INFORMATION

Device	Package	Shipping†
NTLGD3502NT1G	DFN6 (Pb-free)	3000/Tape & Reel
NTLGD3502NT2G	DFN6 (Pb-free)	3000/Tape & Reel

†For information on tape and reel specifications, including part orientation and tape sizes, please refer to our Tape and Reel Packaging Specifications Brochure, BRD8011/D.

## NTLGD3502N

2. Surface Mounted on FR4 Board using the minimum recommended pad size of 30 mm<sup>2</sup>, 1 oz. Cu

# NTLGD3502N

## THERMAL RESISTANCE RATINGS

Parameter	Symbol	Max	Unit
Junction-to-Ambient – Steady State (Note 1)	$R_{\theta JA}$	72	°C/W
Junction-to-Ambient – $t \leq 5$ s (Note 1)	$R_{\theta JA}$	40	
Junction-to-Ambient – Steady State min Pad (Note 2)	$R_{\theta JA}$	110	
Junction-to-Ambient – Pulsed (25% duty cycle) min Pad (Note 2)	$R_{\theta JA}$	60	

## MOSFET I ELECTRICAL CHARACTERISTICS ( $T_J = 25^\circ\text{C}$ unless otherwise noted)

Parameter	Symbol	Test Conditions	Min	Typ	Max	Unit
-----------	--------	-----------------	-----	-----	-----	------

### Off Characteristics

Drain-to-Source Breakdown Voltage	$V_{(BR)DSS}$	$V_{GS} = 0\text{ V}, I_D = 250\ \mu\text{A}$	20			V
Drain-to-Source Breakdown Voltage Temperature Coefficient	$V_{(BR)DSS}/T_J$	$I_D = 250\ \mu\text{A}$ , ref to $25^\circ\text{C}$		10		mV/°C
Zero Gate Voltage Drain Current	$I_{DSS}$	$V_{GS} = 0\text{ V}, V_{DS} = 16\text{ V}$	$T_J = 25^\circ\text{C}$		1.0	$\mu\text{A}$
			$T_J = 125^\circ\text{C}$		10	
Gate-to-Source Leakage Current	$I_{GSS}$	$V_{DS} = 0\text{ V}, V_{GS} = \pm 20\text{ V}$			$\pm 100$	nA

### On Characteristics (Note 3)

Gate Threshold Voltage	$V_{GS(TH)}$	$V_{GS} = V_{DS}, I_D = 250\ \mu\text{A}$	1.0	1.7	2.0	V
Negative Threshold Temperature Coefficient	$V_{GS(TH)}/T_J$			-4.4		mV/°C
Drain-to-Source On Resistance	$R_{DS(on)}$	$V_{GS} = 4.5\text{ V}, I_D = 4.3\text{ A}$		50	60	m $\Omega$
Forward Transconductance	$g_{FS}$	$V_{DS} = 10\text{ V}, I_D = 4.0\text{ A}$		5.9		S

### Charges, Capacitances & Gate Resistance

Input Capacitance	$C_{ISS}$	$V_{GS} = 0\text{ V}, f = 1\text{ MHz}, V_{DS} = 10\text{ V}$		250	480	pF
Output Capacitance	$C_{OSS}$			138	200	
Reverse Transfer Capacitance	$C_{RSS}$			52	90	
Total Gate Charge	$Q_G(TOT)$	$V_{GS} = 4.5\text{ V}, V_{DS} = 10\text{ V}; I_D = 4.3\text{ A}$ (Note 3)		2.9	4.0	nC
Gate-to-Source Charge	$Q_{GS}$			1.0		
Gate-to-Drain Charge	$Q_{GD}$			1.1		
Gate Resistance	$R_G$			1.5		

### Switching Characteristics, $V_{GS} = 4.5\text{ V}$ (Note 4)

Turn-On Delay Time	$t_{d(ON)}$	$V_{GS} = 4.5\text{ V}, V_{DD} = 10\text{ V},$ $I_D = 4.3\text{ A}, R_G = 10\ \Omega$		7.0	12	ns
Rise Time	$t_r$			17.5	25	
Turn-Off Delay Time	$t_{d(OFF)}$			8.6	15	
Fall Time	$t_f$			3.3	5.0	

### Drain-Source Diode Characteristics

Forward Diode Voltage	$V_{SD}$	$V_{GS} = 0\text{ V}, I_S = 1.6\text{ A}$	$T_J = 25^\circ\text{C}$		0.78	1.2	V
			$T_J = 125^\circ\text{C}$		0.63		
Reverse Recovery Time	$t_{RR}$	$V_{GS} = 0\text{ V}, d_{ISD}/d_t = 100\text{ A}/\mu\text{s},$ $I_S = 1.0\text{ A}$		16.7		ns	
Charge Time	$t_a$			8.2			
Discharge Time	$t_b$			8.5			
Reverse Recovery Charge	$Q_{RR}$			7.0		nC	

3. Pulse Test: pulse width  $\leq 300\ \mu\text{s}$ , duty cycle  $\leq 2\%$

4. Switching characteristics are independent of operating junction temperatures

# NTLGD3502N

## MOSFET II ELECTRICAL CHARACTERISTICS ( $T_J = 25^\circ\text{C}$ unless otherwise noted)

Parameter	Symbol	Test Conditions	Min	Typ	Max	Unit
-----------	--------	-----------------	-----	-----	-----	------

### Off Characteristics

Drain-to-Source Breakdown Voltage	$V_{(BR)DSS}$	$V_{GS} = 0\text{ V}, I_D = 250\ \mu\text{A}$	20			V
Drain-to-Source Breakdown Voltage Temperature Coefficient	$V_{(BR)DSS}/T_J$	$I_D = 250\ \mu\text{A}$ , ref to $25^\circ\text{C}$		22		$\text{mV}/^\circ\text{C}$
Zero Gate Voltage Drain Current	$I_{DSS}$	$V_{GS} = 0\text{ V}, V_{DS} = 16\text{ V}$	$T_J = 25^\circ\text{C}$		1	$\mu\text{A}$
			$T_J = 125^\circ\text{C}$		10	
Gate-to-Source Leakage Current	$I_{GSS}$	$V_{DS} = 0\text{ V}, V_{GS} = \pm 12\text{ V}$			$\pm 100$	nA

### On Characteristics (Note 5)

Gate Threshold Voltage	$V_{GS(TH)}$	$V_{GS} = V_{DS}, I_D = 250\ \mu\text{A}$	0.6		2.0	V
Negative Threshold Temperature Coefficient	$V_{GS(TH)}/T_J$			-2.8		$\text{mV}/^\circ\text{C}$
Drain-to-Source On Resistance	$R_{DS(on)}$	$V_{GS} = 4.5\text{ V}, I_D = 3.4\text{ A}$		70	90	$\text{m}\Omega$
		$V_{GS} = 2.5\text{ V}, I_D = 1.7\text{ A}$		95	120	
Forward Transconductance	$g_{FS}$	$V_{DS} = 10\text{ V}, I_D = 3.4\text{ A}$		6.7		S

### Charges, Capacitances & Gate Resistance

Input Capacitance	$C_{ISS}$	$V_{GS} = 0\text{ V}, f = 1\text{ MHz}, V_{DS} = 10\text{ V}$		144	275	$\text{pF}$
Output Capacitance	$C_{OSS}$			67	125	
Reverse Transfer Capacitance	$C_{RSS}$			22	40	
Total Gate Charge	$Q_{G(TOT)}$	$V_{GS} = 4.5\text{ V}, V_{DS} = 10\text{ V}; I_D = 3.4\text{ A}$		2.1	5.0	$\text{nC}$
Threshold Gate Charge	$Q_{G(TH)}$			0.11		
Gate-to-Source Charge	$Q_{GS}$			0.42		
Gate-to-Drain Charge	$Q_{GD}$			0.7		

### Switching Characteristics, $V_{GS} = 4.5\text{ V}$ (Note 6)

Turn-On Delay Time	$t_{d(ON)}$	$V_{GS} = 4.5\text{ V}, V_{DD} = 16\text{ V}, I_D = 3.4\text{ A}, R_G = 10\ \Omega$		4.8	10	ns
Rise Time	$t_r$			13.6	25	
Turn-Off Delay Time	$t_{d(OFF)}$			9.0	20	
Fall Time	$t_f$			1.9	5.0	

### Drain-Source Diode Characteristics

Forward Diode Voltage	$V_{SD}$	$V_{GS} = 0\text{ V}, I_S = 1.7\text{ A}$	$T_J = 25^\circ\text{C}$		0.8	1.15	V
			$T_J = 150^\circ\text{C}$		0.63		
Reverse Recovery Time	$t_{RR}$	$V_{GS} = 0\text{ V}, d_{ISD}/d_t = 100\text{ A}/\mu\text{s}, I_S = 1.0\text{ A}$		12		ns	
Charge Time	$t_a$			8.0			
Discharge Time	$t_b$			4.0			
Reverse Recovery Charge	$Q_{RR}$			5.0			nC

5. Pulse Test: pulse width  $\leq 300\ \mu\text{s}$ , duty cycle  $\leq 2\%$

6. Switching characteristics are independent of operating junction temperatures

# NTLGD3502N

## TYPICAL MOSFET I N-CHANNEL PERFORMANCE CURVES

( $T_J = 25^\circ\text{C}$  unless otherwise noted)

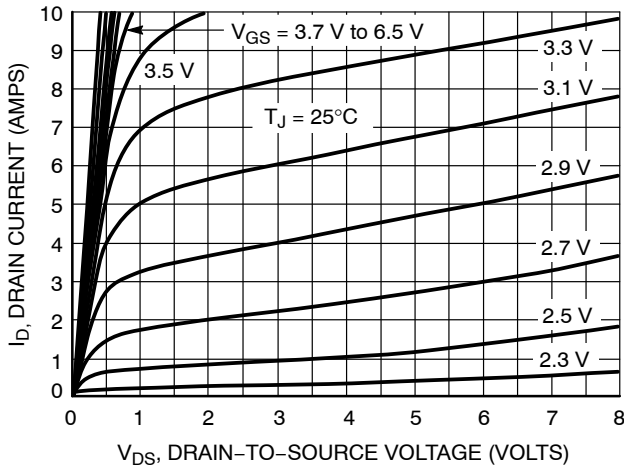

**Figure 1. On-Region Characteristics**

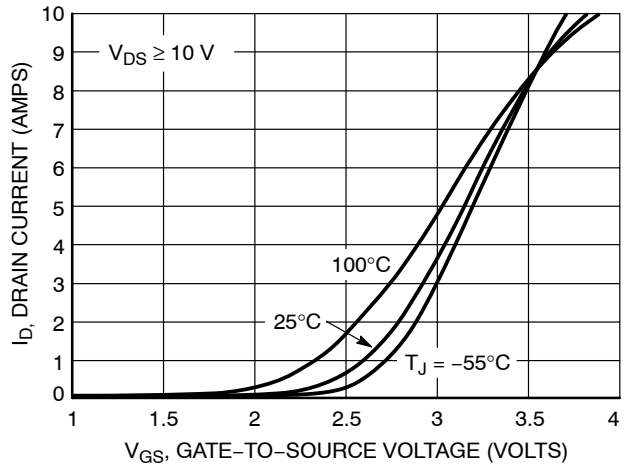

**Figure 2. Transfer Characteristics**

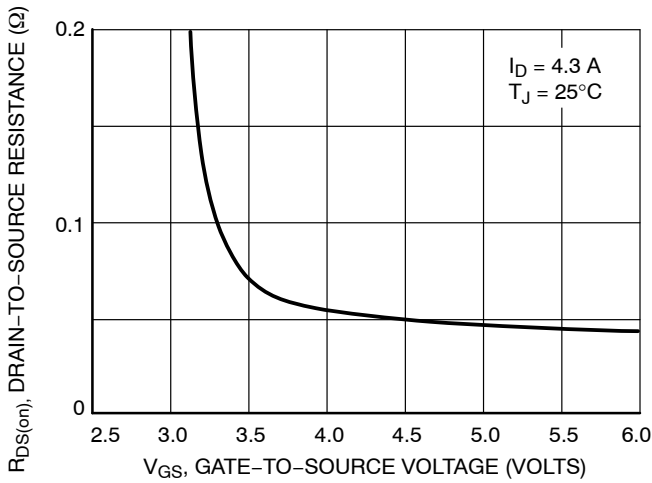

**Figure 3. On-Resistance vs. Gate-to-Source Voltage**

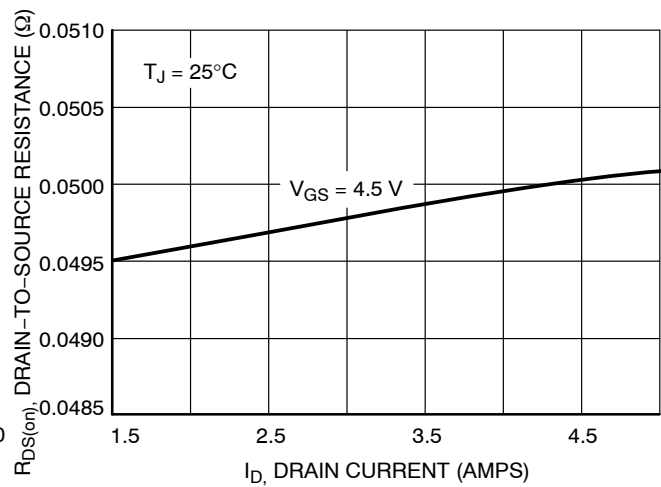

**Figure 4. On-Resistance vs. Drain Current and Gate Voltage**

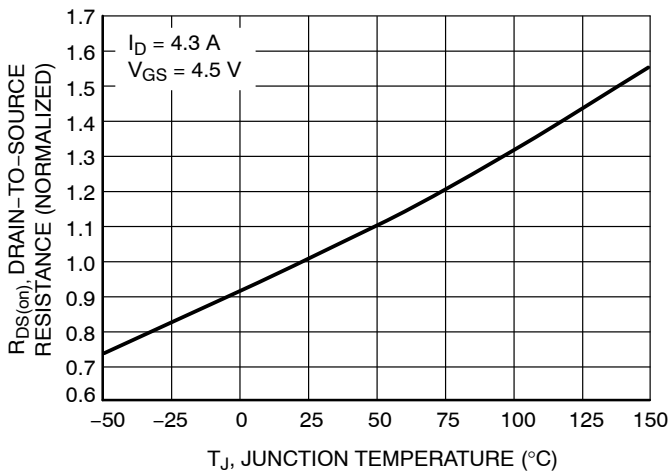

**Figure 5. On-Resistance Variation with Temperature**

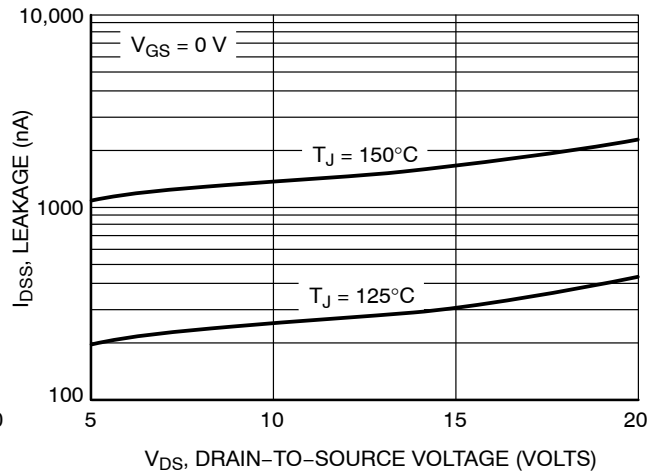

**Figure 6. Drain-to-Source Leakage Current vs. Voltage**

# NTLGD3502N

## TYPICAL MOSFET I N-CHANNEL PERFORMANCE CURVES

( $T_J = 25^\circ\text{C}$  unless otherwise noted)

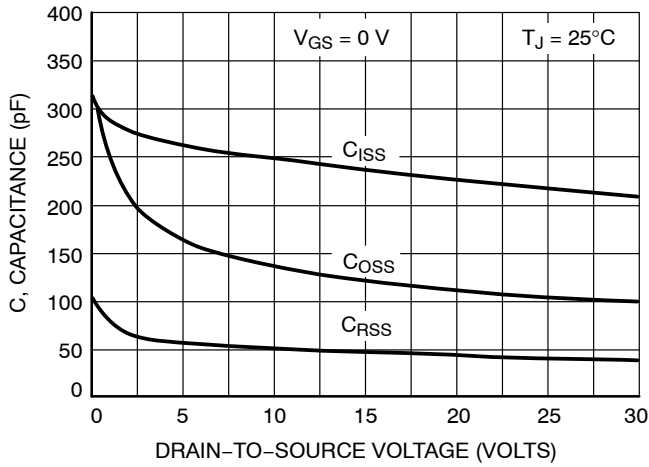

Figure 7. Capacitance Variation

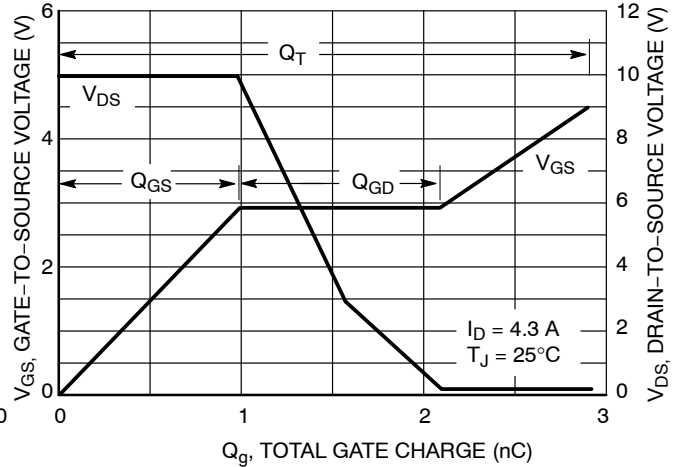

Figure 8. Gate-to-Source and Drain-to-Source Voltage vs. Total Charge

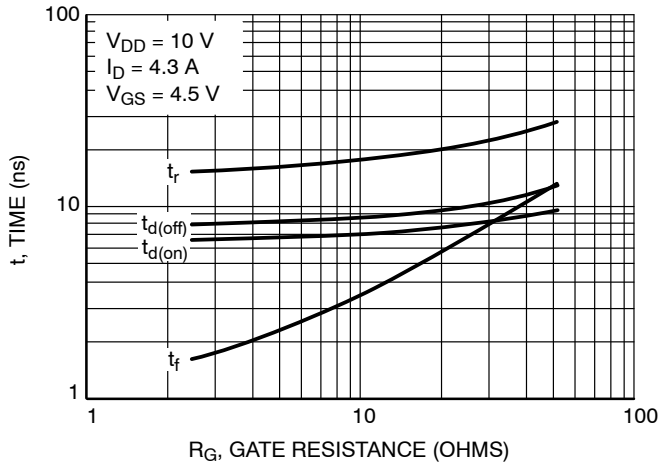

Figure 9. Resistive Switching Time Variation vs. Gate Resistance

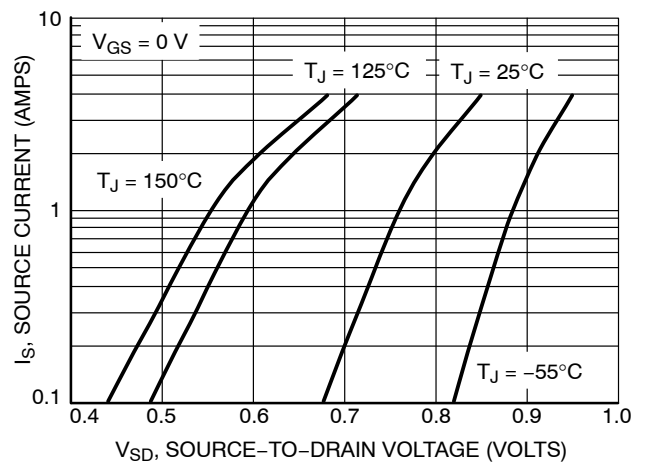

Figure 10. Diode Forward Voltage vs. Current

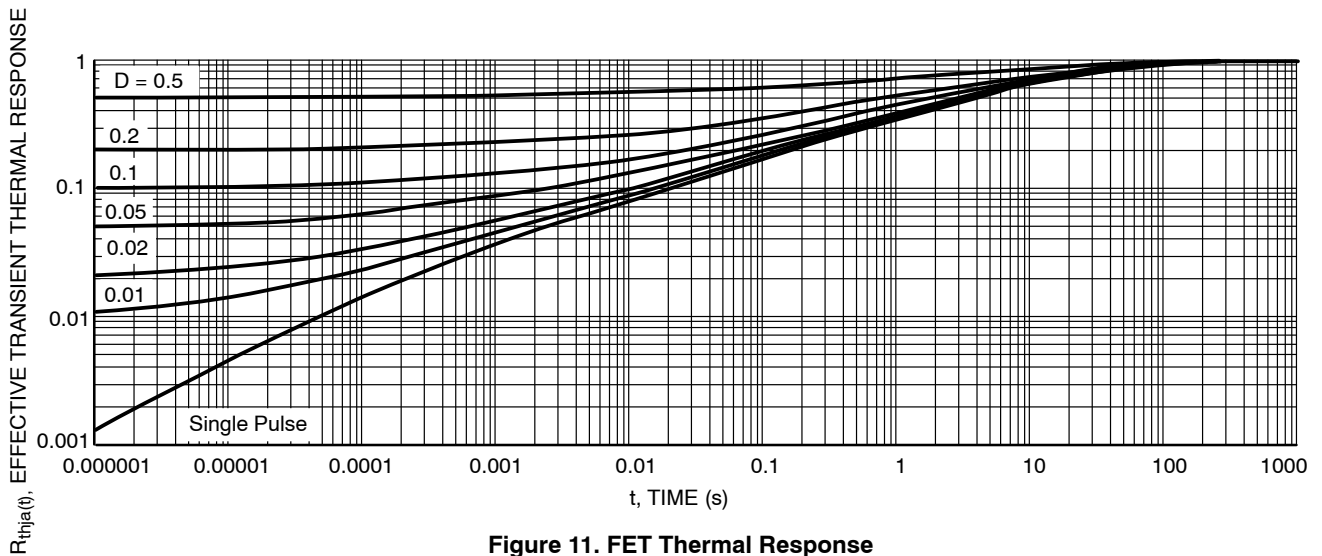

Figure 11. FET Thermal Response

# NTLGD3502N

## TYPICAL MOSFET II N-CHANNEL PERFORMANCE CURVES

( $T_J = 25^\circ\text{C}$  unless otherwise noted)

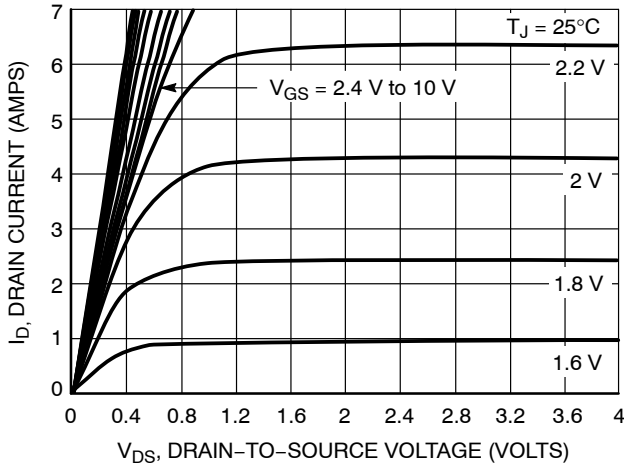

Figure 12. On-Region Characteristics

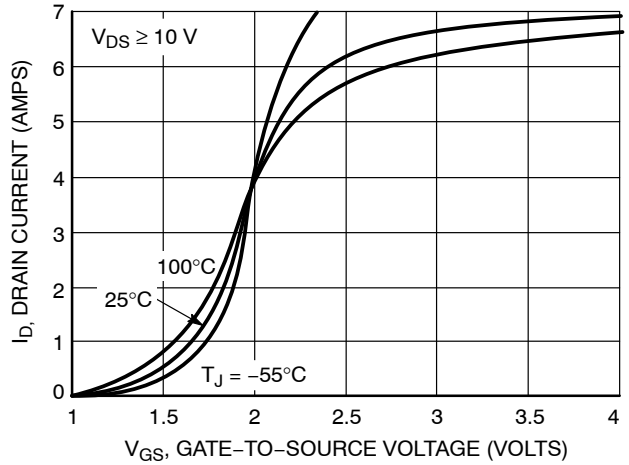

Figure 13. Transfer Characteristics

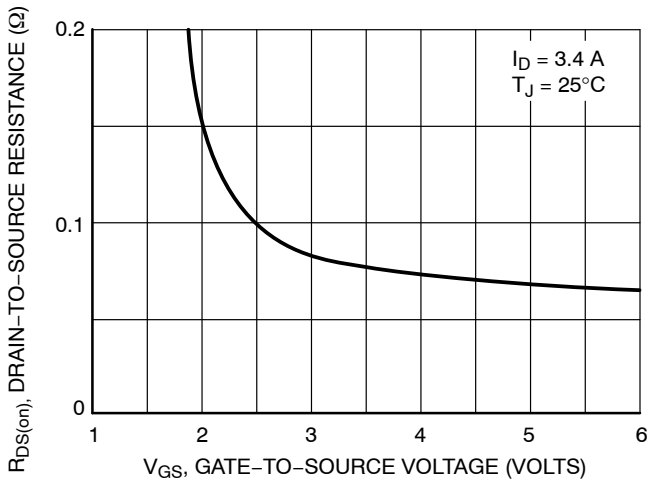

Figure 14. On-Resistance vs. Gate-to-Source Voltage

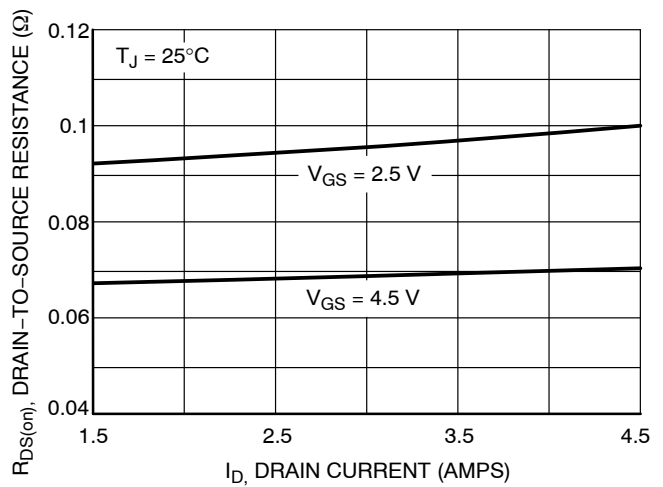

Figure 15. On-Resistance vs. Drain Current and Gate Voltage

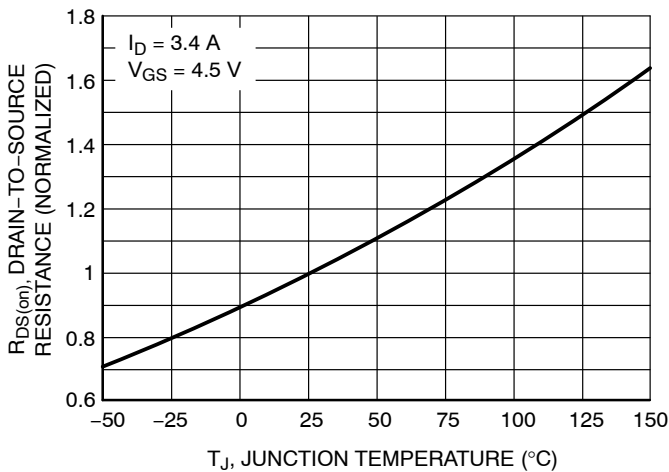

Figure 16. On-Resistance Variation with Temperature

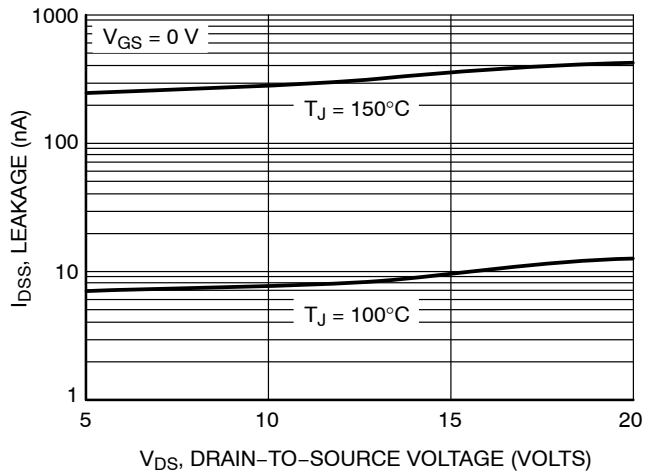

Figure 17. Drain-to-Source Leakage Current vs. Voltage

# NTLGD3502N

## TYPICAL MOSFET II N-CHANNEL PERFORMANCE CURVES

( $T_J = 25^\circ\text{C}$  unless otherwise noted)

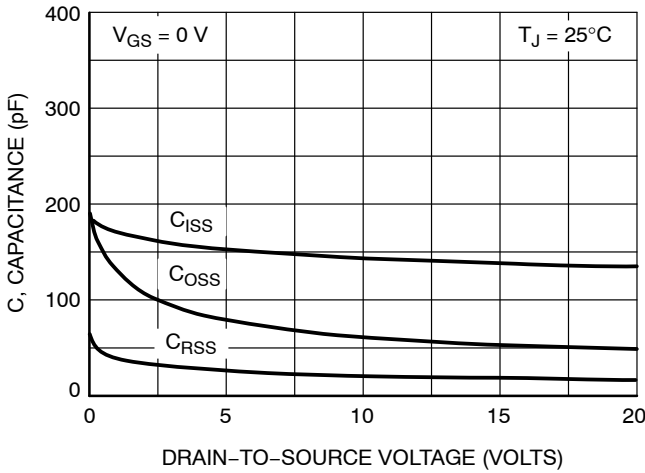

Figure 18. Capacitance Variation

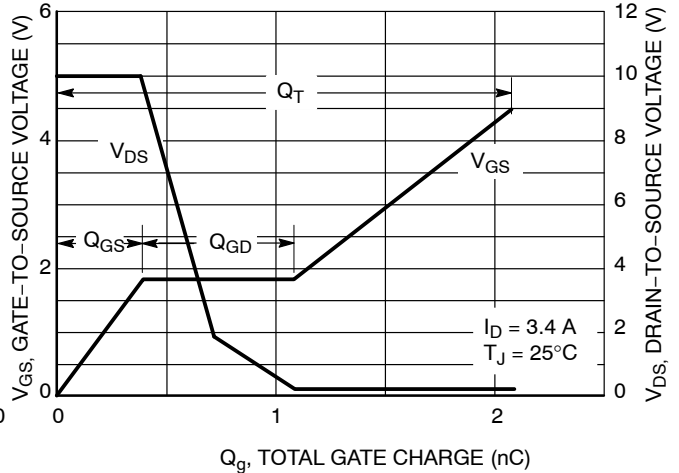

Figure 19. Gate-to-Source and Drain-to-Source Voltage vs. Total Charge

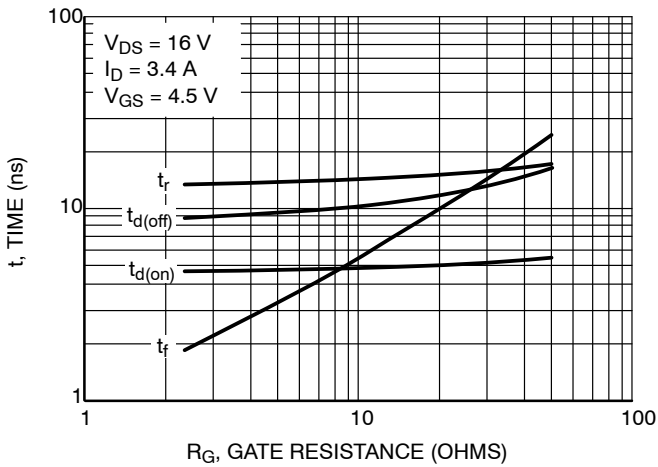

Figure 20. Resistive Switching Time Variation vs. Gate Resistance

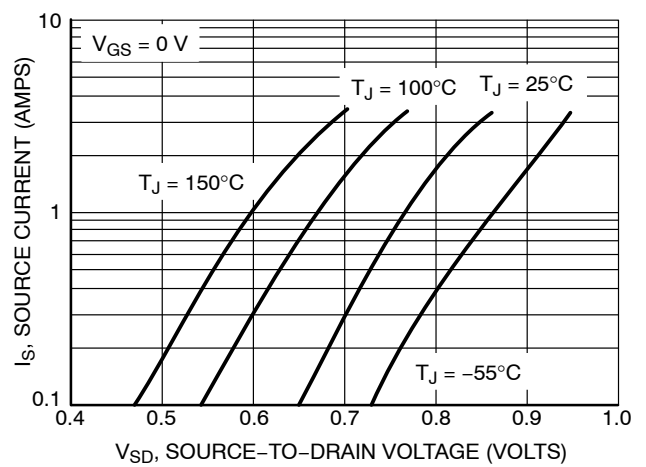

Figure 21. Diode Forward Voltage vs. Current

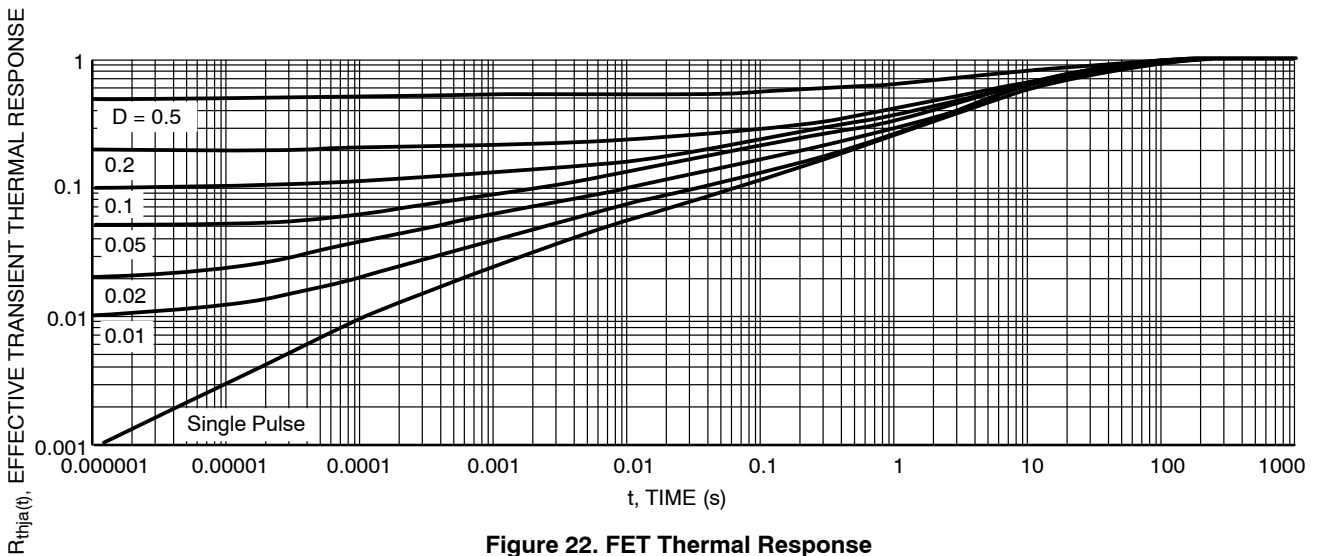

Figure 22. FET Thermal Response



# MECHANICAL CASE OUTLINE

## PACKAGE DIMENSIONS

ON Semiconductor®



STYLE 1    STYLE 2

SCALE 1:1

### SMA CASE 403D ISSUE H

DATE 23 SEP 2015

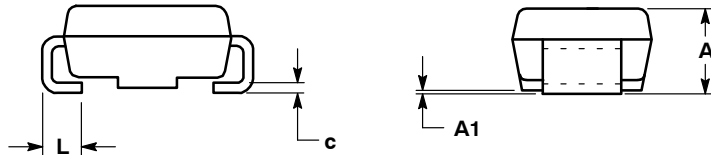
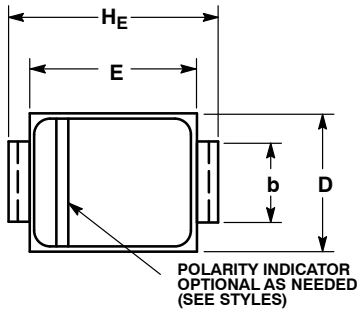

#### SOLDERING FOOTPRINT\*

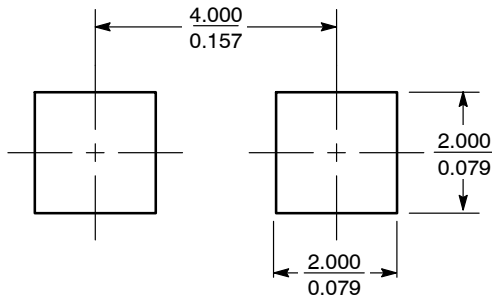

SCALE 8:1 (mm/inches)

\*For additional information on our Pb-Free strategy and soldering details, please download the ON Semiconductor Soldering and Mounting Techniques Reference Manual, SOLDERRM/D.

#### NOTES:

1. DIMENSIONING AND TOLERANCING PER ANSI Y14.5M, 1982.
2. CONTROLLING DIMENSION: INCH.
3. DIMENSION b SHALL BE MEASURED WITHIN DIMENSION L.

DIM	MILLIMETERS			INCHES		
	MIN	NOM	MAX	MIN	NOM	MAX
A	1.97	2.10	2.20	0.078	0.083	0.087
A1	0.05	0.10	0.20	0.002	0.004	0.008
b	1.27	1.45	1.63	0.050	0.057	0.064
c	0.15	0.28	0.41	0.006	0.011	0.016
D	2.29	2.60	2.92	0.090	0.103	0.115
E	4.06	4.32	4.57	0.160	0.170	0.180
HE	4.83	5.21	5.59	0.190	0.205	0.220
L	0.76	1.14	1.52	0.030	0.045	0.060

#### GENERIC MARKING DIAGRAM\*

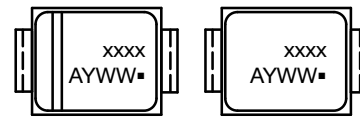

STYLE 1

STYLE 2

- xxxx = Specific Device Code
- A = Assembly Location
- Y = Year
- WW = Work Week
- = Pb-Free Package

\*This information is generic. Please refer to device data sheet for actual part marking. Pb-Free indicator, "G" or microdot "■", may or may not be present.

STYLE 1:  
PIN 1. CATHODE (POLARITY BAND)  
2. ANODE

STYLE 2:  
NO POLARITY

<b>DOCUMENT NUMBER:</b>	<b>98AON04079D</b>	Electronic versions are uncontrolled except when accessed directly from the Document Repository. Printed versions are uncontrolled except when stamped "CONTROLLED COPY" in red.
<b>DESCRIPTION:</b>	<b>SMA</b>	<b>PAGE 1 OF 1</b>

ON Semiconductor and are trademarks of Semiconductor Components Industries, LLC dba ON Semiconductor or its subsidiaries in the United States and/or other countries. ON Semiconductor reserves the right to make changes without further notice to any products herein. ON Semiconductor makes no warranty, representation or guarantee regarding the suitability of its products for any particular purpose, nor does ON Semiconductor assume any liability arising out of the application or use of any product or circuit, and specifically disclaims any and all liability, including without limitation special, consequential or incidental damages. ON Semiconductor does not convey any license under its patent rights nor the rights of others.

**onsemi**, **Onsemi**, and other names, marks, and brands are registered and/or common law trademarks of Semiconductor Components Industries, LLC dba "**onsemi**" or its affiliates and/or subsidiaries in the United States and/or other countries. **onsemi** owns the rights to a number of patents, trademarks, copyrights, trade secrets, and other intellectual property. A listing of **onsemi**'s product/patent coverage may be accessed at [www.onsemi.com/site/pdf/Patent-Marking.pdf](http://www.onsemi.com/site/pdf/Patent-Marking.pdf). **onsemi** reserves the right to make changes at any time to any products or information herein, without notice. The information herein is provided "as-is" and **onsemi** makes no warranty, representation or guarantee regarding the accuracy of the information, product features, availability, functionality, or suitability of its products for any particular purpose, nor does **onsemi** assume any liability arising out of the application or use of any product or circuit, and specifically disclaims any and all liability, including without limitation special, consequential or incidental damages. Buyer is responsible for its products and applications using **onsemi** products, including compliance with all laws, regulations and safety requirements or standards, regardless of any support or applications information provided by **onsemi**. "Typical" parameters which may be provided in **onsemi** data sheets and/or specifications can and do vary in different applications and actual performance may vary over time. All operating parameters, including "Typicals" must be validated for each customer application by customer's technical experts. **onsemi** does not convey any license under any of its intellectual property rights nor the rights of others. **onsemi** products are not designed, intended, or authorized for use as a critical component in life support systems or any FDA Class 3 medical devices or medical devices with a same or similar classification in a foreign jurisdiction or any devices intended for implantation in the human body. Should Buyer purchase or use **onsemi** products for any such unintended or unauthorized application, Buyer shall indemnify and hold **onsemi** and its officers, employees, subsidiaries, affiliates, and distributors harmless against all claims, costs, damages, and expenses, and reasonable attorney fees arising out of, directly or indirectly, any claim of personal injury or death associated with such unintended or unauthorized use, even if such claim alleges that **onsemi** was negligent regarding the design or manufacture of the part. **onsemi** is an Equal Opportunity/Affirmative Action Employer. This literature is subject to all applicable copyright laws and is not for resale in any manner.

## ADDITIONAL INFORMATION

### TECHNICAL PUBLICATIONS:

Technical Library: [www.onsemi.com/design/resources/technical-documentation](http://www.onsemi.com/design/resources/technical-documentation)  
onsemi Website: [www.onsemi.com](http://www.onsemi.com)

### ONLINE SUPPORT: [www.onsemi.com/support](http://www.onsemi.com/support)

For additional information, please contact your local Sales Representative at [www.onsemi.com/support/sales](http://www.onsemi.com/support/sales)

