

# MOSFET – Power, Complementary, WDFN

## 2X2 mm

### 20 V/-20 V, 4.6 A/-4.1 A

## NTLJD3119C

#### Features

- Complementary N-Channel and P-Channel MOSFET
- WDFN Package with Exposed Drain Pad for Excellent Thermal Conduction
- Footprint Same as SC-88 Package
- Leading Edge Trench Technology for Low On Resistance
- 1.8 V Gate Threshold Voltage
- Low Profile (< 0.8 mm) for Easy Fit in Thin Environments
- This is a Pb-Free Device

#### Applications

- Synchronous DC-DC Conversion Circuits
- Load/Power Management of Portable Devices like PDA's, Cellular Phones and Hard Drives
- Color Display and Camera Flash Regulators

| $V_{(BR)DSS}$      | $R_{DS(on) MAX}$ | $I_D MAX$ |
|--------------------|------------------|-----------|
| N-Channel<br>20 V  | 65 mΩ @ 4.5 V    | 3.8 A     |
|                    | 85 mΩ @ 2.5 V    | 2.0 A     |
|                    | 120 mΩ @ 1.8 V   | 1.7 A     |
| P-Channel<br>-20 V | 100 mΩ @ -4.5 V  | -4.1 A    |
|                    | 135 mΩ @ -2.5 V  | -2.0 A    |
|                    | 200 mΩ @ -1.8 V  | -1.6 A    |

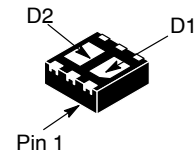

**WDFN6  
CASE 506AN**

#### MARKING DIAGRAM

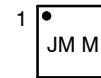

JM = Specific Device Code  
M = Date Code  
▪ = Pb-Free Package  
(Note: Microdot may be in either location)

#### PIN CONNECTIONS

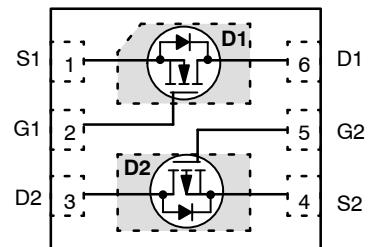

(Top View)

#### ORDERING INFORMATION

| Device        | Package            | Shipping†        |
|---------------|--------------------|------------------|
| NTLJD3119CTBG | WDFN6<br>(Pb-Free) | 3000/Tape & Reel |

†For information on tape and reel specifications, including part orientation and tape sizes, please refer to our Tape and Reel Packaging Specification Brochure, BRD8011/D.

# NTLJD3119C

## MAXIMUM RATINGS (T<sub>J</sub> = 25°C unless otherwise noted)

| Parameter   |              |                        | Symbol                            | Value      | Unit |
|---|--------------|------------------------|-----------------------------------|------------|------|
| Drain-to-Source Voltage   | N-Ch         |                        | V <sub>DSS</sub>                  | 20         | V    |
|   | P-Ch         |                        |                                   | -20        |      |
| Gate-to-Source Voltage  | N-Ch         |                        | V <sub>GS</sub>                   | ±8.0       | V    |
|   | P-Ch         |                        |                                   |            |      |
| <b>N-Channel</b><br>Continuous Drain Current (Note 1)             | Steady State | T <sub>A</sub> = 25°C  | I <sub>D</sub>                    | 3.8        | A    |
|   |              | T <sub>A</sub> = 85°C  |                                   | 2.8        |      |
|   | t ≤ 5 s      | T <sub>A</sub> = 25°C  | 4.6                               |            |      |
| <b>P-Channel</b><br>Continuous Drain Current (Note 1)             | Steady State | T <sub>A</sub> = 25°C  | I <sub>D</sub>                    | -3.3       | A    |
|   |              | T <sub>A</sub> = 85°C  |                                   | -2.4       |      |
|   | t ≤ 5 s      | T <sub>A</sub> = 25°C  | -4.1                              |            |      |
| Power Dissipation (Note 1)  | Steady State | T <sub>A</sub> = 25°C  | P <sub>D</sub>                    | 1.5        | W    |
|   | t ≤ 5 s      |                        |                                   | 2.3        |      |
| <b>N-Channel</b><br>Continuous Drain Current (Note 2)             | Steady State | T <sub>A</sub> = 25°C  | I <sub>D</sub>                    | 2.6        | A    |
|   |              | T <sub>A</sub> = 85°C  |                                   | 1.9        |      |
| <b>P-Channel</b><br>Continuous Drain Current (Note 2)             | Steady State | T <sub>A</sub> = 25°C  | I <sub>D</sub>                    | -2.3       | A    |
|   |              | T <sub>A</sub> = 85°C  |                                   | -1.6       |      |
| Power Dissipation (Note 2)  | Steady State | T <sub>A</sub> = 25°C  | P <sub>D</sub>                    | 0.71       | W    |
| Pulsed Drain Current  | N-Ch         | t <sub>p</sub> = 10 μs | I <sub>DM</sub>                   | 18         | A    |
|   | P-Ch         |                        |                                   | -20        |      |
| Operating Junction and Storage Temperature                        |              |                        | T <sub>J</sub> , T <sub>STG</sub> | -55 to 150 | °C   |
| Lead Temperature for Soldering Purposes (1/8" from case for 10 s) |              |                        | T <sub>L</sub>                    | 260        | °C   |

Stresses exceeding those listed in the Maximum Ratings table may damage the device. If any of these limits are exceeded, device functionality should not be assumed, damage may occur and reliability may be affected.

- Surface Mounted on FR4 Board using 1 in sq pad size (Cu area = 1.127 in sq [2 oz] including traces).
- Surface Mounted on FR4 Board using the minimum recommended pad size of 30 mm<sup>2</sup>, 2 oz Cu.

## THERMAL RESISTANCE RATINGS

| Parameter | Symbol | Max | Unit |
|-----------|--------|-----|------|
|-----------|--------|-----|------|

### SINGLE OPERATION (SELF-HEATED)

|   |                  |     |      |
|---|------------------|-----|------|
| Junction-to-Ambient – Steady State (Note 3)         | R <sub>θJA</sub> | 83  | °C/W |
| Junction-to-Ambient – Steady State Min Pad (Note 4) | R <sub>θJA</sub> | 177 |      |
| Junction-to-Ambient – t ≤ 5 s (Note 3)              | R <sub>θJA</sub> | 54  |      |

### DUAL OPERATION (EQUALLY HEATED)

|   |                  |     |      |
|---|------------------|-----|------|
| Junction-to-Ambient – Steady State (Note 3)         | R <sub>θJA</sub> | 58  | °C/W |
| Junction-to-Ambient – Steady State Min Pad (Note 4) | R <sub>θJA</sub> | 133 |      |
| Junction-to-Ambient – t ≤ 5 s (Note 3)              | R <sub>θJA</sub> | 40  |      |

- Surface Mounted on FR4 Board using 1 in sq pad size (Cu area = 1.127 in sq [2 oz] including traces).
- Surface Mounted on FR4 Board using the minimum recommended pad size (30 mm<sup>2</sup>, 2 oz Cu).

# NTLJD3119C

## ELECTRICAL CHARACTERISTICS (T<sub>J</sub> = 25°C unless otherwise noted)

| Parameter   | Symbol                               | N/P | Test Conditions                                 | Min                      | Typ  | Max  | Unit  |
|---|--------------------------------------|-----|---|--------------------------|------|------|-------|
| <b>OFF CHARACTERISTICS</b>                                |                                      |     |   |                          |      |      |       |
| Drain-to-Source Breakdown Voltage                         | V <sub>(BR)DSS</sub>                 | N   | V <sub>GS</sub> = 0 V                           | I <sub>D</sub> = 250 μA  | 20   |      | V     |
|   |                                      | P   |   | I <sub>D</sub> = -250 μA | -20  |      |       |
| Drain-to-Source Breakdown Voltage Temperature Coefficient | V <sub>(BR)DSS</sub> /T <sub>J</sub> | N   |   |                          | 10.4 |      | mV/°C |
|   |                                      | P   |   |                          | 9.95 |      |       |
| Zero Gate Voltage Drain Current                           | I <sub>DSS</sub>                     | N   | V <sub>GS</sub> = 0 V, V <sub>DS</sub> = 16 V   | T <sub>J</sub> = 25 °C   |      | 1.0  | μA    |
|   |                                      | P   | V <sub>GS</sub> = 0 V, V <sub>DS</sub> = -16 V  |                          |      | -1.0 |       |
|   |                                      | N   | V <sub>GS</sub> = 0 V, V <sub>DS</sub> = 16 V   | T <sub>J</sub> = 85 °C   |      | 10   |       |
|   |                                      | P   | V <sub>GS</sub> = 0 V, V <sub>DS</sub> = -16 V  |                          |      | -10  |       |
| Gate-to-Source Leakage Current                            | I <sub>GSS</sub>                     | N   | V <sub>DS</sub> = 0 V, V <sub>GS</sub> = ±8.0 V |                          |      | ±100 | nA    |
|   |                                      | P   | V <sub>DS</sub> = 0 V, V <sub>GS</sub> = ±8.0 V |                          |      | ±100 |       |

## ON CHARACTERISTICS (Note 5)

|  |                                     |   |   |                          |      |      |      |       |
|--|-------------------------------------|---|---|--------------------------|------|------|------|-------|
| Gate Threshold Voltage                 | V <sub>GS(TH)</sub>                 | N | V <sub>GS</sub> = V <sub>DS</sub>                 | I <sub>D</sub> = 250 μA  | 0.4  | 0.7  | 1.0  | V     |
|  |                                     | P |   | I <sub>D</sub> = -250 μA | -0.4 | -0.7 | -1.0 |       |
| Gate Threshold Temperature Coefficient | V <sub>GS(TH)</sub> /T <sub>J</sub> | N |   |                          |      | -3.0 |      | mV/°C |
|  |                                     | P |   |                          |      | 2.44 |      |       |
| Drain-to-Source On Resistance          | R <sub>DS(on)</sub>                 | N | V <sub>GS</sub> = 4.5 V, I <sub>D</sub> = 3.8 A   |                          |      | 37   | 65   | mΩ    |
|  |                                     | P | V <sub>GS</sub> = -4.5 V, I <sub>D</sub> = -4.1 A |                          |      | 75   | 100  |       |
|  |                                     | N | V <sub>GS</sub> = 2.5 V, I <sub>D</sub> = 2.0 A   |                          |      | 46   | 85   |       |
|  |                                     | P | V <sub>GS</sub> = -2.5 V, I <sub>D</sub> = -2.0 A |                          |      | 101  | 135  |       |
|  |                                     | N | V <sub>GS</sub> = 1.8 V, I <sub>D</sub> = 1.7 A   |                          |      | 65   | 120  |       |
|  |                                     | P | V <sub>GS</sub> = -1.8 V, I <sub>D</sub> = -1.6 A |                          |      | 150  | 200  |       |
| Forward Transconductance               | g <sub>FS</sub>                     | N | V <sub>DS</sub> = 10 V, I <sub>D</sub> = 1.7 A    |                          |      | 4.2  |      | S     |
|  |                                     | P | V <sub>DS</sub> = -5.0 V, I <sub>D</sub> = -2.0 A |                          |      | 3.1  |      |       |

## CHARGES, CAPACITANCES AND GATE RESISTANCE

|                              |                     |   |  |  |  |     |     |    |  |    |
|------------------------------|---------------------|---|--|--|--|-----|-----|----|--|----|
| Input Capacitance            | C <sub>ISS</sub>    | N | f = 1.0 MHz, V <sub>GS</sub> = 0 V   | V <sub>DS</sub> = 10 V   |  | 271 |     | pF |  |    |
|                              |                     | P |  | V <sub>DS</sub> = -10 V  |  | 531 |     |    |  |    |
| Output Capacitance           | C <sub>OSS</sub>    | N |  | V <sub>DS</sub> = 10 V   |  | 72  |     |    |  |    |
|                              |                     | P |  | V <sub>DS</sub> = -10 V  |  | 91  |     |    |  |    |
| Reverse Transfer Capacitance | C <sub>RSS</sub>    | N |  | V <sub>DS</sub> = 10 V   |  | 43  |     |    |  |    |
|                              |                     | P |  | V <sub>DS</sub> = -10 V  |  | 56  |     |    |  |    |
| Total Gate Charge            | Q <sub>G(TOT)</sub> | N |  | V <sub>GS</sub> = 4.5 V, V <sub>DS</sub> = 10 V, I <sub>D</sub> = 3.8 A    |  |     | 3.7 |    |  | nC |
|                              |                     | P |  | V <sub>GS</sub> = -4.5 V, V <sub>DS</sub> = -10 V, I <sub>D</sub> = -2.0 A |  |     | 5.5 |    |  |    |
| Threshold Gate Charge        | Q <sub>G(TH)</sub>  | N |  | V <sub>GS</sub> = 4.5 V, V <sub>DS</sub> = 10 V, I <sub>D</sub> = 3.8 A    |  |     | 0.3 |    |  |    |
|                              |                     | P |  | V <sub>GS</sub> = -4.5 V, V <sub>DS</sub> = -10 V, I <sub>D</sub> = -2.0 A |  |     | 0.7 |    |  |    |
| Gate-to-Source Charge        | Q <sub>GS</sub>     | N | V <sub>GS</sub> = 4.5 V, V <sub>DS</sub> = 10 V, I <sub>D</sub> = 3.8 A    |  |  | 0.6 |     |    |  |    |
|                              |                     | P | V <sub>GS</sub> = -4.5 V, V <sub>DS</sub> = -10 V, I <sub>D</sub> = -2.0 A |  |  | 1.0 |     |    |  |    |
| Gate-to-Drain Charge         | Q <sub>GD</sub>     | N | V <sub>GS</sub> = 4.5 V, V <sub>DS</sub> = 10 V, I <sub>D</sub> = 3.8 A    |  |  | 1.0 |     |    |  |    |
|                              |                     | P | V <sub>GS</sub> = -4.5 V, V <sub>DS</sub> = -10 V, I <sub>D</sub> = -2.0 A |  |  | 1.4 |     |    |  |    |

# NTLJD3119C

## ELECTRICAL CHARACTERISTICS (T<sub>J</sub> = 25°C unless otherwise noted)

| Parameter                                 | Symbol              | N/P | Test Conditions   | Min | Typ  | Max | Unit |
|---|---------------------|-----|---|-----|------|-----|------|
| <b>SWITCHING CHARACTERISTICS</b> (Note 6) |                     |     |   |     |      |     |      |
| Turn-On Delay Time                        | t <sub>d(ON)</sub>  | N   | V <sub>GS</sub> = 4.5 V, V <sub>DD</sub> = 16 V,<br>I <sub>D</sub> = 1.0 A, R <sub>G</sub> = 2.0 Ω    |     | 3.8  |     | ns   |
| Rise Time                                 | t <sub>r</sub>      |     |   |     | 4.7  |     |      |
| Turn-Off Delay Time                       | t <sub>d(OFF)</sub> |     |   |     | 11.1 |     |      |
| Fall Time                                 | t <sub>f</sub>      |     |   |     | 5.8  |     |      |
| Turn-On Delay Time                        | t <sub>d(ON)</sub>  | P   | V <sub>GS</sub> = -4.5 V, V <sub>DD</sub> = -10 V,<br>I <sub>D</sub> = -2.0 A, R <sub>G</sub> = 2.0 Ω |     | 5.2  |     |      |
| Rise Time                                 | t <sub>r</sub>      |     |   |     | 13.2 |     |      |
| Turn-Off Delay Time                       | t <sub>d(OFF)</sub> |     |   |     | 13.7 |     |      |
| Fall Time                                 | t <sub>f</sub>      |     |   |     | 19.1 |     |      |

## DRAIN-SOURCE DIODE CHARACTERISTICS

|                         |                 |   |   |                         |  |       |      |    |
|-------------------------|-----------------|---|---|-------------------------|--|-------|------|----|
| Forward Diode Voltage   | V <sub>SD</sub> | N | V <sub>GS</sub> = 0 V, T <sub>J</sub> = 25 °C             | I <sub>S</sub> = 1.0 A  |  | 0.69  | 1.0  | V  |
|                         |                 | P |   | I <sub>S</sub> = -1.0 A |  | -0.75 | -1.0 |    |
|                         |                 | N | V <sub>GS</sub> = 0 V, T <sub>J</sub> = 125 °C            | I <sub>S</sub> = 1.0 A  |  | 0.52  |      |    |
|                         |                 | P |   | I <sub>S</sub> = -1.0 A |  | -0.64 |      |    |
| Reverse Recovery Time   | t <sub>RR</sub> | N | V <sub>GS</sub> = 0 V,<br>dI <sub>S</sub> / dt = 100 A/μs | I <sub>S</sub> = 1.0 A  |  | 10.2  |      | ns |
|                         |                 | P |   | I <sub>S</sub> = -1.0 A |  | 16.2  |      |    |
| Charge Time             | t <sub>a</sub>  | N |   | I <sub>S</sub> = 1.0 A  |  | 6.0   |      |    |
|                         |                 | P |   | I <sub>S</sub> = -1.0 A |  | 10.6  |      |    |
| Discharge Time          | t <sub>b</sub>  | N |   | I <sub>S</sub> = 1.0 A  |  | 4.2   |      | nC |
|                         |                 | P |   | I <sub>S</sub> = -1.0 A |  | 5.6   |      |    |
| Reverse Recovery Charge | Q <sub>RR</sub> | N |   | I <sub>S</sub> = 1.0 A  |  | 3.0   |      | nC |
|                         |                 | P |   | I <sub>S</sub> = -1.0 A |  | 5.7   |      |    |

5. Pulse Test: pulse width ≤ 300 μs, duty cycle ≤ 2%.

6. Switching characteristics are independent of operating junction temperatures.

# NTLJD3119C

## TYPICAL PERFORMANCE CURVES – N-CHANNEL ( $T_J = 25^\circ\text{C}$ unless otherwise noted)

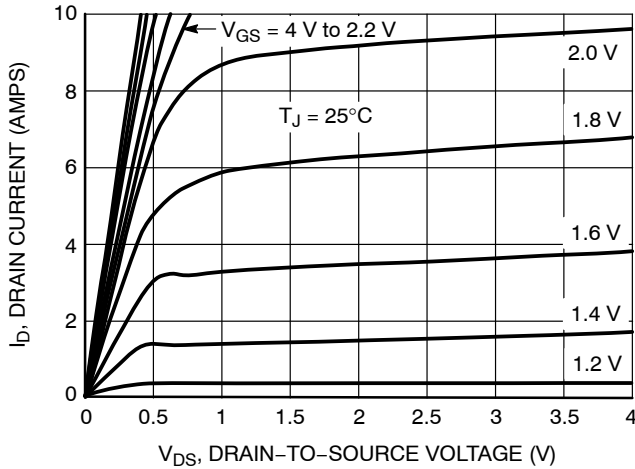

Figure 1. On-Region Characteristics

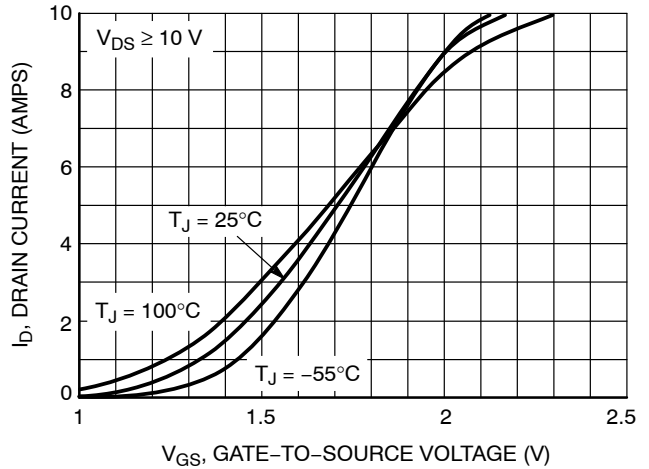

Figure 2. Transfer Characteristics

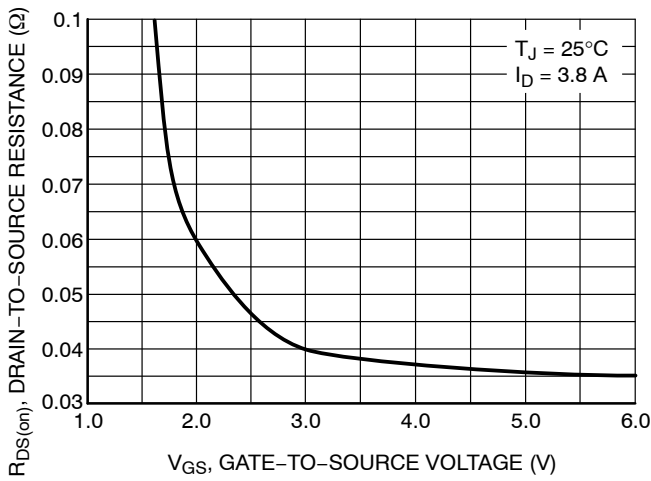

Figure 3. On-Resistance versus Drain Current

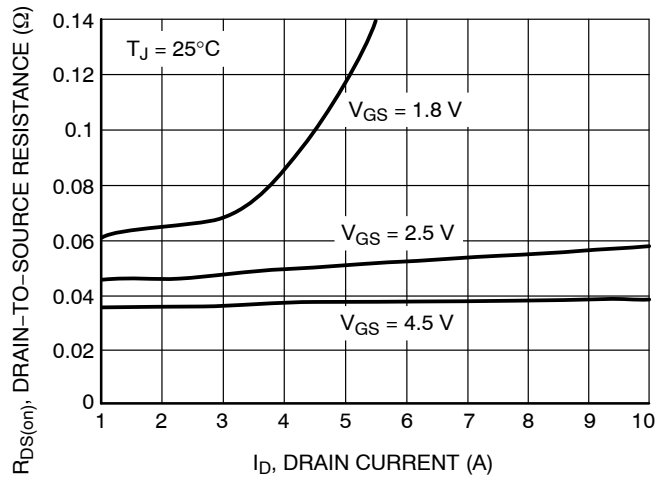

Figure 4. On-Resistance versus Drain Current and Gate Voltage

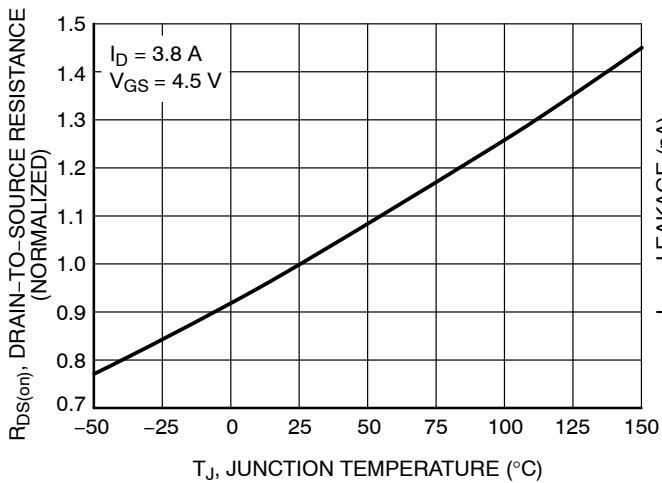

Figure 5. On-Resistance Variation with Temperature

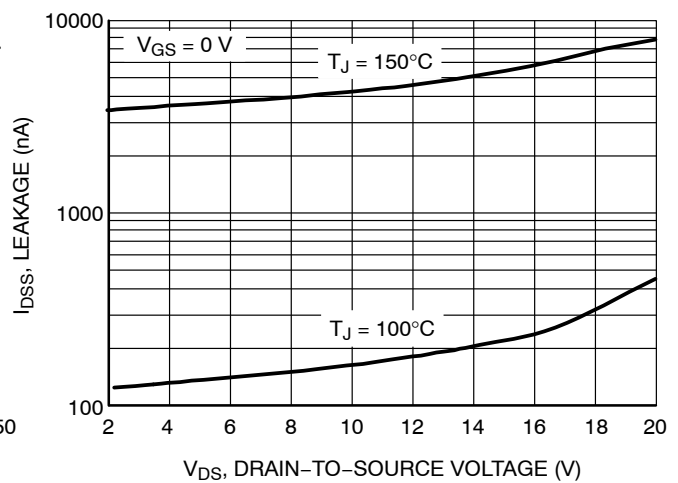

Figure 6. Drain-to-Source Leakage Current versus Voltage

TYPICAL PERFORMANCE CURVES – N-CHANNEL ( $T_J = 25^\circ\text{C}$  unless otherwise noted)

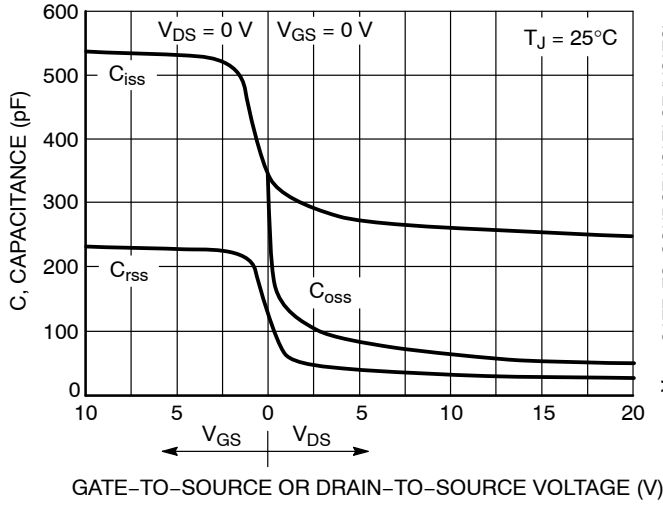

Figure 7. Capacitance Variation

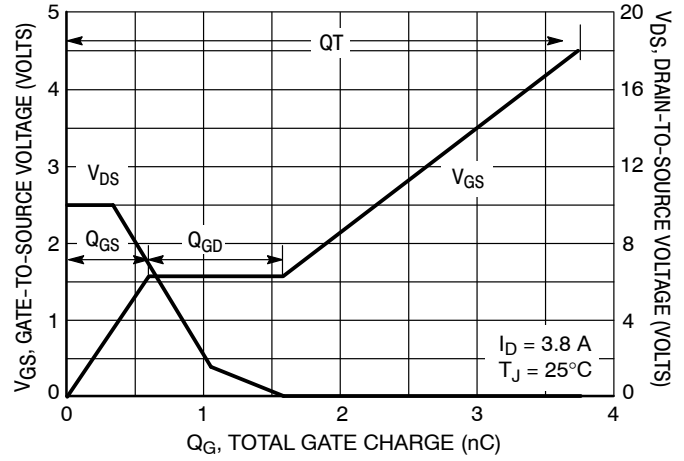

Figure 8. Gate-To-Source and Drain-To-Source Voltage versus Total Charge

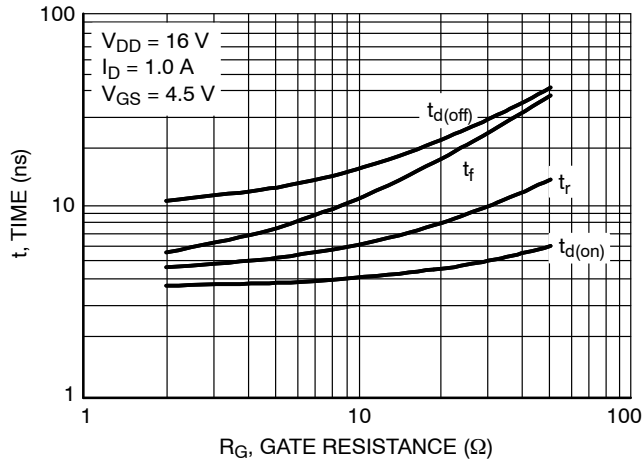

Figure 9. Resistive Switching Time Variation versus Gate Resistance

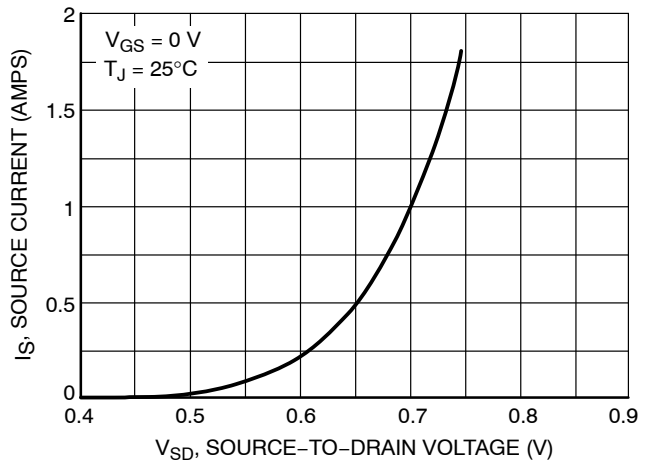
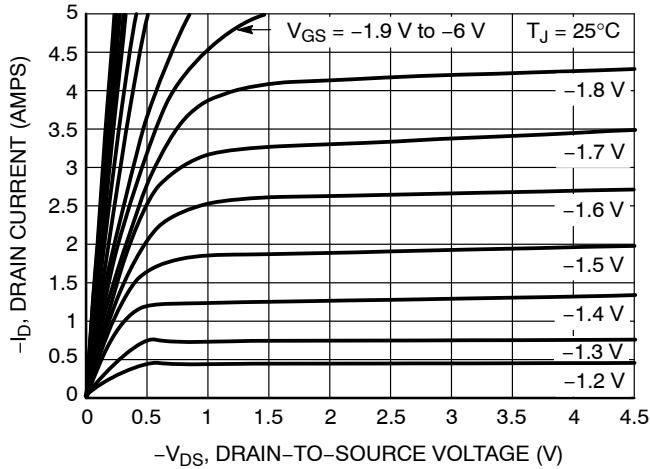

Figure 10. Diode Forward Voltage versus Current

# NTLJD3119C

## TYPICAL PERFORMANCE CURVES – P-CHANNEL ( $T_J = 25^\circ\text{C}$ unless otherwise noted)



**Figure 11. On-Region Characteristics**

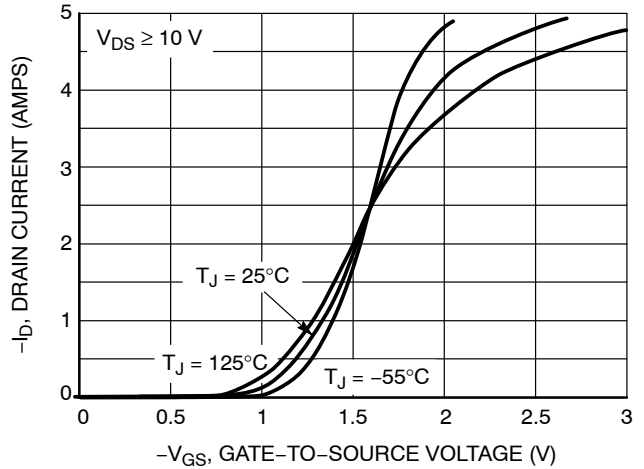

**Figure 12. Transfer Characteristics**

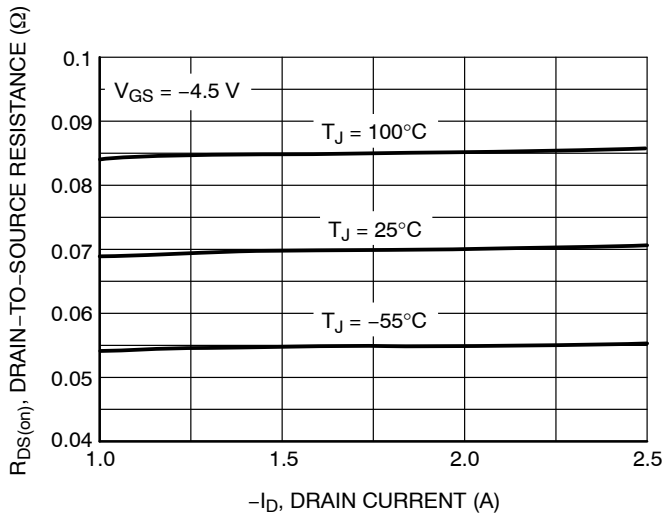

**Figure 13. On-Resistance versus Drain Current**

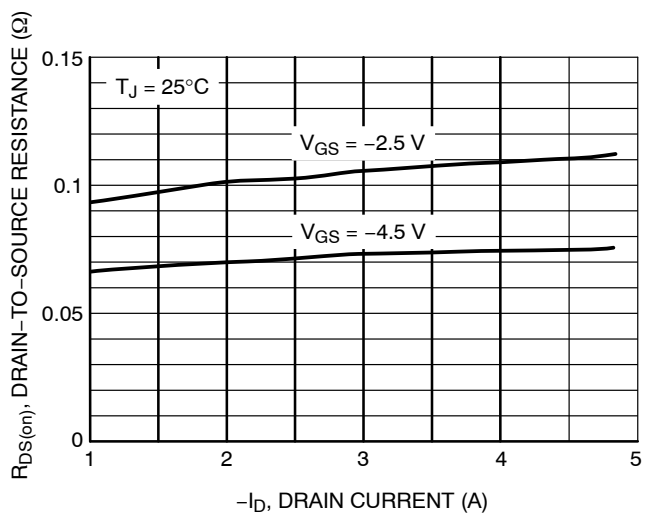

**Figure 14. On-Resistance versus Drain Current and Gate Voltage**

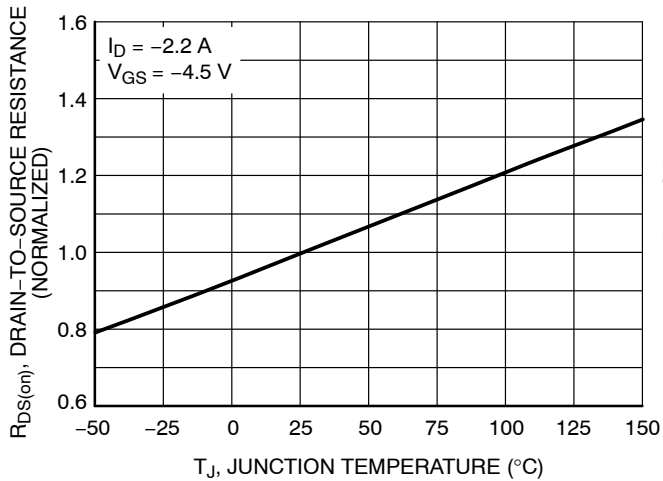

**Figure 15. On-Resistance Variation with Temperature**

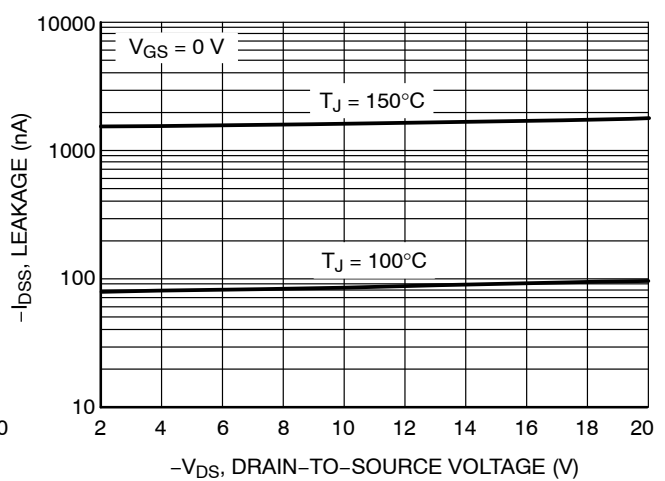

**Figure 16. Drain-to-Source Leakage Current versus Voltage**

TYPICAL PERFORMANCE CURVES – P-CHANNEL ( $T_J = 25^\circ\text{C}$  unless otherwise noted)

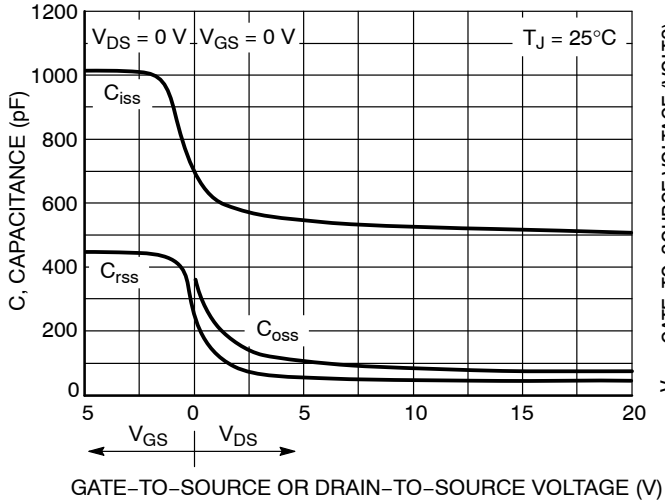

Figure 17. Capacitance Variation

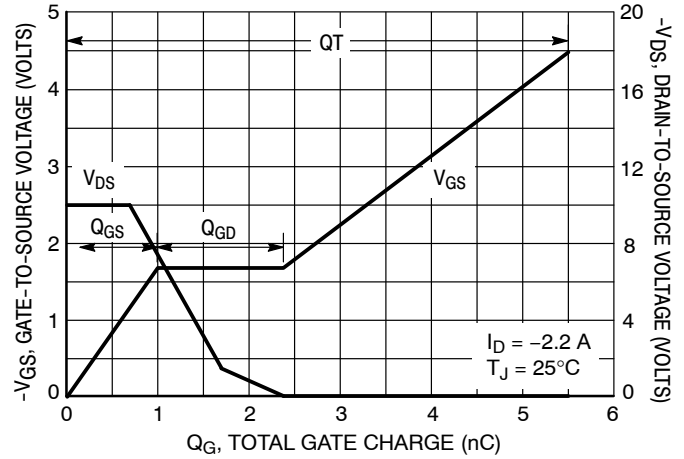

Figure 18. Gate-To-Source and Drain-To-Source Voltage versus Total Charge

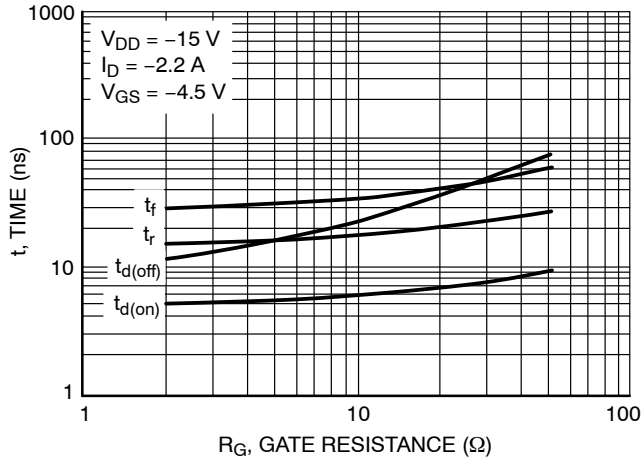

Figure 19. Resistive Switching Time Variation versus Gate Resistance

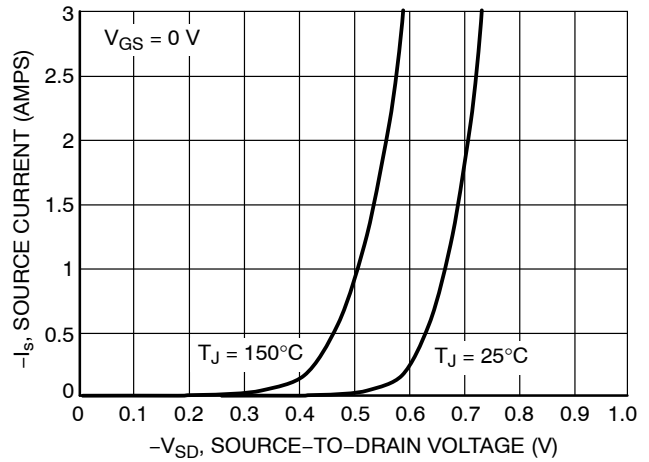

Figure 20. Diode Forward Voltage versus Current

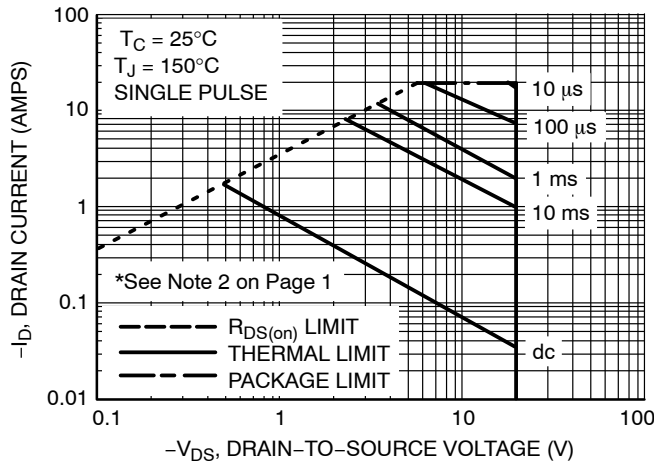

Figure 21. Maximum Rated Forward Biased Safe Operating Area



# NTLJD3119C

## TYPICAL PERFORMANCE CURVES ( $T_J = 25^\circ\text{C}$ unless otherwise noted)

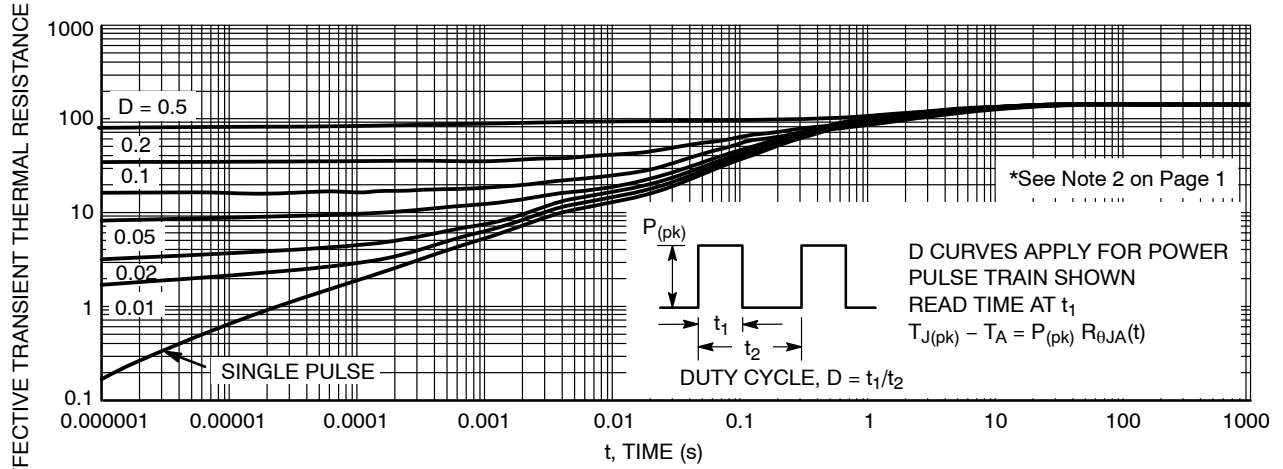
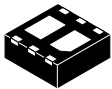
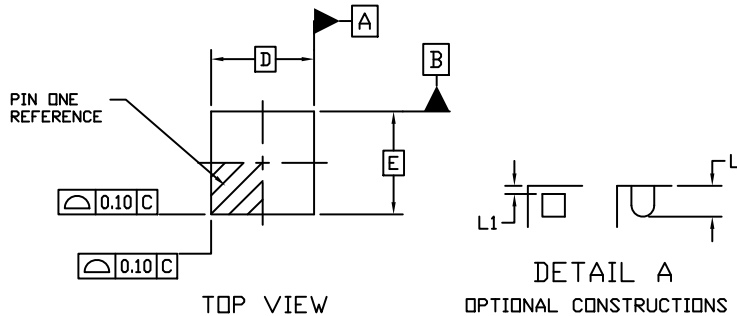

Figure 22. Thermal Response



WDFN6 2x2, 0.65P  
CASE 506AN  
ISSUE H

DATE 25 JAN 2022



NOTES:

1. DIMENSIONING AND TOLERANCING PER ASME Y14.5M, 1994.
2. CONTROLLING DIMENSION: MILLIMETERS
3. DIMENSION *b* APPLIES TO PLATED TERMINAL AND IS MEASURED BETWEEN 0.15 AND 0.30 MM FROM THE TERMINAL TIP.
4. COPLANARITY APPLIES TO THE EXPOSED PADS AS WELL AS THE TERMINALS.

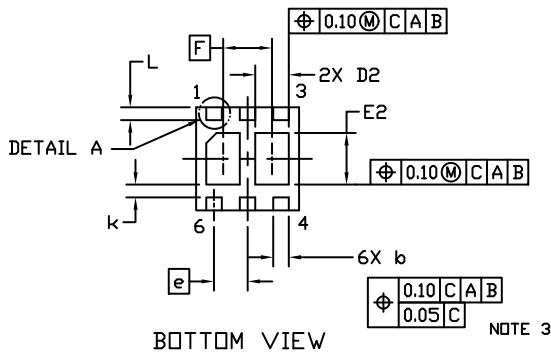
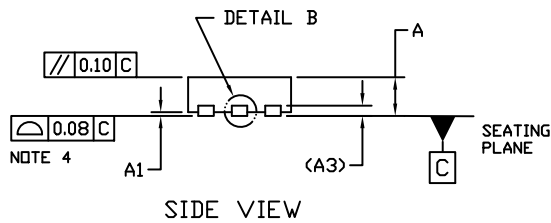

| DIM      | MILLIMETERS |      |
|----------|-------------|------|
|          | MIN.        | MAX. |
| A        | 0.70        | 0.80 |
| A1       | 0.00        | 0.05 |
| A3       | 0.20 REF    |      |
| <i>b</i> | 0.25        | 0.35 |
| D        | 2.00 BSC    |      |
| D2       | 0.57        | 0.77 |
| E        | 2.00 BSC    |      |
| E2       | 0.90        | 1.10 |
| <i>e</i> | 0.65 BSC    |      |
| F        | 0.95 BSC    |      |
| <i>k</i> | 0.25 REF    |      |
| L        | 0.20        | 0.30 |
| L1       | ---         | 0.10 |

GENERIC MARKING DIAGRAM\*



XX = Specific Device Code  
M = Date Code

\*This information is generic. Please refer to device data sheet for actual part marking. Pb-Free indicator, "G" or microdot "▪", may or may not be present. Some products may not follow the Generic Marking.

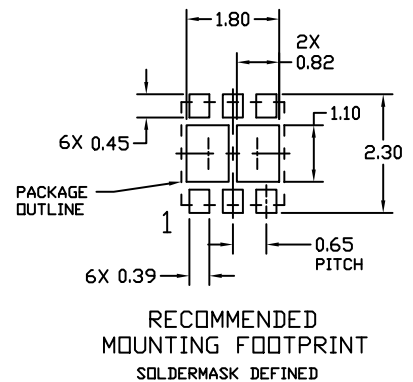

|                  |                  |  |
|------------------|------------------|--|
| DOCUMENT NUMBER: | 98AON20861D      | Electronic versions are uncontrolled except when accessed directly from the Document Repository. Printed versions are uncontrolled except when stamped "CONTROLLED COPY" in red. |
| DESCRIPTION:     | WDFN6 2x2, 0.65P | PAGE 1 OF 1  |

onsemi and onsemi are trademarks of Semiconductor Components Industries, LLC dba onsemi or its subsidiaries in the United States and/or other countries. onsemi reserves the right to make changes without further notice to any products herein. onsemi makes no warranty, representation or guarantee regarding the suitability of its products for any particular purpose, nor does onsemi assume any liability arising out of the application or use of any product or circuit, and specifically disclaims any and all liability, including without limitation special, consequential or incidental damages. onsemi does not convey any license under its patent rights nor the rights of others.

**onsemi**, **Onsemi**, and other names, marks, and brands are registered and/or common law trademarks of Semiconductor Components Industries, LLC dba "**onsemi**" or its affiliates and/or subsidiaries in the United States and/or other countries. **onsemi** owns the rights to a number of patents, trademarks, copyrights, trade secrets, and other intellectual property. A listing of **onsemi**'s product/patent coverage may be accessed at [www.onsemi.com/site/pdf/Patent-Marking.pdf](http://www.onsemi.com/site/pdf/Patent-Marking.pdf). **onsemi** reserves the right to make changes at any time to any products or information herein, without notice. The information herein is provided "as-is" and **onsemi** makes no warranty, representation or guarantee regarding the accuracy of the information, product features, availability, functionality, or suitability of its products for any particular purpose, nor does **onsemi** assume any liability arising out of the application or use of any product or circuit, and specifically disclaims any and all liability, including without limitation special, consequential or incidental damages. Buyer is responsible for its products and applications using **onsemi** products, including compliance with all laws, regulations and safety requirements or standards, regardless of any support or applications information provided by **onsemi**. "Typical" parameters which may be provided in **onsemi** data sheets and/or specifications can and do vary in different applications and actual performance may vary over time. All operating parameters, including "Typicals" must be validated for each customer application by customer's technical experts. **onsemi** does not convey any license under any of its intellectual property rights nor the rights of others. **onsemi** products are not designed, intended, or authorized for use as a critical component in life support systems or any FDA Class 3 medical devices or medical devices with a same or similar classification in a foreign jurisdiction or any devices intended for implantation in the human body. Should Buyer purchase or use **onsemi** products for any such unintended or unauthorized application, Buyer shall indemnify and hold **onsemi** and its officers, employees, subsidiaries, affiliates, and distributors harmless against all claims, costs, damages, and expenses, and reasonable attorney fees arising out of, directly or indirectly, any claim of personal injury or death associated with such unintended or unauthorized use, even if such claim alleges that **onsemi** was negligent regarding the design or manufacture of the part. **onsemi** is an Equal Opportunity/Affirmative Action Employer. This literature is subject to all applicable copyright laws and is not for resale in any manner.

## ADDITIONAL INFORMATION

### TECHNICAL PUBLICATIONS:

Technical Library: [www.onsemi.com/design/resources/technical-documentation](http://www.onsemi.com/design/resources/technical-documentation)  
onsemi Website: [www.onsemi.com](http://www.onsemi.com)

### ONLINE SUPPORT: [www.onsemi.com/support](http://www.onsemi.com/support)

For additional information, please contact your local Sales Representative at [www.onsemi.com/support/sales](http://www.onsemi.com/support/sales)