

NTMFD4901NF

MOSFET – Power, Dual, N-Channel with Integrated Schottky, SO8FL

30 V, High Side 18 A / Low Side 30 A

Features

- Co-Packaged Power Stage Solution to Minimize Board Space
- Low Side MOSFET with Integrated Schottky
- Minimized Parasitic Inductances
- Optimized Devices to Reduce Power Losses
- These Devices are Pb-Free, Halogen Free/BFR Free and are RoHS Compliant

Applications

- DC-DC Converters
- System Voltage Rails
- Point of Load



ON Semiconductor®

<http://onsemi.com>

V _{(BR)DSS}	R _{DS(ON)} MAX	I _D MAX
Q1 Top FET 30 V	6.5 mΩ @ 10 V	18 A
	10 mΩ @ 4.5 V	
Q2 Bottom FET 30 V	2.35 mΩ @ 10 V	30 A
	3.5 mΩ @ 4.5 V	

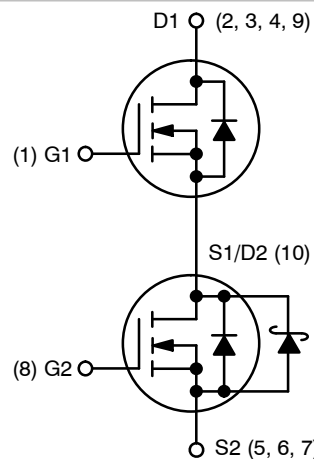

PIN CONNECTIONS

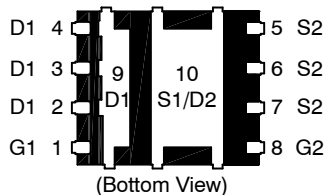

MARKING DIAGRAM

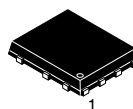

DFN8
CASE 506BX

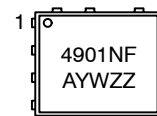

4901NF = Specific Device Code
 A = Assembly Location
 Y = Year
 W = Work Week
 ZZ = Lot Traceability

ORDERING INFORMATION

See detailed ordering and shipping information in the package dimensions section on page 5 of this data sheet.

NTMFD4901NF

MAXIMUM RATINGS ($T_J = 25^\circ\text{C}$ unless otherwise stated)

Parameter			Symbol	Value	Unit
Drain-to-Source Voltage	Q1		V_{DSS}	30	V
Drain-to-Source Voltage	Q2				
Gate-to-Source Voltage	Q1		V_{GS}	± 20	V
Gate-to-Source Voltage	Q2				
Continuous Drain Current $R_{\theta JA}$ (Note 1)		$T_A = 25^\circ\text{C}$	Q1	13.5	A
			Q2	23.4	
		$T_A = 85^\circ\text{C}$	Q1	9.7	
			Q2	16.9	
Power Dissipation $R_{\theta JA}$ (Note 1)		$T_A = 25^\circ\text{C}$	Q1	1.90	W
			Q2	2.07	
Continuous Drain Current $R_{\theta JA} \leq 10$ s (Note 1)	Steady State	$T_A = 25^\circ\text{C}$	Q1	18.2	A
			Q2	30.3	
		$T_A = 85^\circ\text{C}$	Q1	13.1	
			Q2	21.8	
Power Dissipation $R_{\theta JA} \leq 10$ s (Note 1)		$T_A = 25^\circ\text{C}$	Q1	3.45	W
			Q2	3.45	
Continuous Drain Current $R_{\theta JA}$ (Note 2)		$T_A = 25^\circ\text{C}$	Q1	10.3	A
			Q2	17.9	
		$T_A = 85^\circ\text{C}$	Q1	7.4	
			Q2	12.9	
Power Dissipation $R_{\theta JA}$ (Note 2)		$T_A = 25^\circ\text{C}$	Q1	1.10	W
			Q2	1.20	
Pulsed Drain Current		$T_A = 25^\circ\text{C}$ $t_p = 10 \mu\text{s}$	Q1	60	A
			Q2	100	
Operating Junction and Storage Temperature	Q1		T_J, T_{STG}	-55 to +150	$^\circ\text{C}$
	Q2				
Source Current (Body Diode)	Q1		I_S	3.4	A
	Q2			4.9	
Drain to Source dV/dt			dV/dt	6	V/ns
Single Pulse Drain-to-Source Avalanche Energy ($T_J = 25^\circ\text{C}$, $V_{DD} = 50$ V, $V_{GS} = 10$ V, $I_L = XX$ A _{pk} , $L = 0.1$ mH, $R_G = 25 \Omega$)	24 A	Q1	EAS	28.8	mJ
	48 A	Q2	EAS	115	
Lead Temperature for Soldering Purposes (1/8" from case for 10 s)			T_L	260	$^\circ\text{C}$

Stresses exceeding Maximum Ratings may damage the device. Maximum Ratings are stress ratings only. Functional operation above the Recommended Operating Conditions is not implied. Extended exposure to stresses above the Recommended Operating Conditions may affect device reliability.

- Surface-mounted on FR4 board using 1 sq-in pad, 2 oz Cu.
- Surface-mounted on FR4 board using the minimum recommended pad size of 100 mm².

NTMFD4901NF

THERMAL RESISTANCE MAXIMUM RATINGS

Parameter	FET	Symbol	Value	Unit
Junction-to-Ambient – Steady State (Note 3)	Q1	$R_{\theta JA}$	65.9	°C/W
	Q2		60.5	
Junction-to-Ambient – Steady State (Note 4)	Q1	$R_{\theta JA}$	113.2	
	Q2		104	
Junction-to-Ambient – ($t \leq 10$ s) (Note 3)	Q1	$R_{\theta JA}$	36.2	
	Q2		36.2	

3. Surface-mounted on FR4 board using 1 sq-in pad, 2 oz Cu.

4. Surface-mounted on FR4 board using the minimum recommended pad size of 100 mm².

ELECTRICAL CHARACTERISTICS ($T_J = 25^\circ\text{C}$ unless otherwise specified)

Parameter	FET	Symbol	Test Condition	Min	Typ	Max	Unit
OFF CHARACTERISTICS							
Drain-to-Source Break-down Voltage	Q1	$V_{(BR)DSS}$	$V_{GS} = 0\text{ V}, I_D = 250\ \mu\text{A}$	30			V
	Q2		$V_{GS} = 0\text{ V}, I_D = 1\text{ mA}$	30			
Drain-to-Source Break-down Voltage Temperature Coefficient	Q1	$V_{(BR)DSS} / T_J$			18		mV / °C
	Q2				15		
Zero Gate Voltage Drain Current	Q1	I_{DSS}	$V_{GS} = 0\text{ V}, V_{DS} = 24\text{ V}$	$T_J = 25^\circ\text{C}$		1	μA
				$T_J = 125^\circ\text{C}$		10	
	Q2		$V_{GS} = 0\text{ V}, V_{DS} = 24\text{ V}$	$T_J = 25^\circ\text{C}$		500	
Gate-to-Source Leakage Current	Q1	I_{GSS}	$V_{GS} = 0\text{ V}, V_{DS} = \pm 20\text{ V}$			± 100	nA
	Q2					± 100	

ON CHARACTERISTICS (Note 5)

Gate Threshold Voltage	Q1	$V_{GS(TH)}$	$V_{GS} = V_{DS}, I_D = 250\ \mu\text{A}$		1.2		2.2	V
	Q2				1.2		2.2	
Negative Threshold Temperature Coefficient	Q1	$V_{GS(TH)} / T_J$				4.5		mV / °C
	Q2					4.0		
Drain-to-Source On Resistance	Q1	$R_{DS(on)}$	$V_{GS} = 10\text{ V}$	$I_D = 10\text{ A}$		5.2	6.5	mΩ
			$V_{GS} = 4.5\text{ V}$	$I_D = 10\text{ A}$		8.0	10	
	Q2		$V_{GS} = 10\text{ V}$	$I_D = 20\text{ A}$		1.9	2.35	
			$V_{GS} = 4.5\text{ V}$	$I_D = 20\text{ A}$		2.8	3.5	
Forward Transconductance	Q1	g_{FS}	$V_{DS} = 1.5\text{ V}, I_D = 10\text{ A}$			28		S
	Q2					45		

5. Pulse Test: pulse width $\leq 300\ \mu\text{s}$, duty cycle $\leq 2\%$.

6. Switching characteristics are independent of operating junction temperatures.

NTMFD4901NF

ELECTRICAL CHARACTERISTICS (T_J = 25°C unless otherwise specified)

Parameter	FET	Symbol	Test Condition	Min	Typ	Max	Unit
CHARGES, CAPACITANCES & GATE RESISTANCE							
Input Capacitance	Q1	C _{ISS}	V _{GS} = 0 V, f = 1 MHz, V _{DS} = 15 V		1150		pF
	Q2				2950		
Output Capacitance	Q1	C _{OSS}			360		
	Q2				1100		
Reverse Capacitance	Q1	C _{RSS}			105		
	Q2				82		
Total Gate Charge	Q1	Q _{G(TOT)}	V _{GS} = 4.5 V, V _{DS} = 15 V; I _D = 10 A		9.7		nC
	Q2				20		
Threshold Gate Charge	Q1	Q _{G(TH)}			1.1		
	Q2				2.7		
Gate-to-Source Charge	Q1	Q _{GS}			3.3		
	Q2				7.3		
Gate-to-Drain Charge	Q1	Q _{GD}			3.7		
	Q2			5.3			
Total Gate Charge	Q1	Q _{G(TOT)}	V _{GS} = 10 V, V _{DS} = 15 V; I _D = 10 A		19.1		nC
	Q2				42.7		

SWITCHING CHARACTERISTICS (Note 6)

Turn-On Delay Time	Q1	t _{d(ON)}	V _{GS} = 4.5 V, V _{DS} = 15 V, I _D = 10 A, R _G = 3.0 Ω		9.0		ns
	Q2				14		
Rise Time	Q1	t _r			15		
	Q2				16		
Turn-Off Delay Time	Q1	t _{d(OFF)}			14		
	Q2				25		
Fall Time	Q1	t _f			4.0		
	Q2				7.0		

SWITCHING CHARACTERISTICS (Note 6)

Turn-On Delay Time	Q1	t _{d(ON)}	V _{GS} = 10 V, V _{DS} = 15 V, I _D = 10 A, R _G = 3.0 Ω		6.0		ns
	Q2				10		
Rise Time	Q1	t _r			14		
	Q2				15		
Turn-Off Delay Time	Q1	t _{d(OFF)}			17		
	Q2				32		
Fall Time	Q1	t _f			3.0		
	Q2				5.0		

5. Pulse Test: pulse width ≤ 300 μs, duty cycle ≤ 2%.

6. Switching characteristics are independent of operating junction temperatures.

NTMFD4901NF

ELECTRICAL CHARACTERISTICS ($T_J = 25^\circ\text{C}$ unless otherwise specified)

Parameter	FET	Symbol	Test Condition	Min	Typ	Max	Unit
-----------	-----	--------	----------------	-----	-----	-----	------

DRAIN-SOURCE DIODE CHARACTERISTICS

Parameter	FET	Symbol	Test Condition	Min		Max		Unit
				Q1	Q2	Q1	Q2	
Forward Voltage	Q1	V_{SD}	$V_{GS} = 0\text{ V}, I_S = 3\text{ A}$	$T_J = 25^\circ\text{C}$	0.75	1.0	V	
				$T_J = 125^\circ\text{C}$	0.62			
	Q2		$T_J = 25^\circ\text{C}$	0.45	0.70			
			$T_J = 125^\circ\text{C}$	0.37				
Reverse Recovery Time	Q1	t_{RR}	$V_{GS} = 0\text{ V}, dI_S/dt = 100\text{ A}/\mu\text{s}, I_S = 3\text{ A}$		23		ns	
	Q2				40			
Charge Time	Q1	t_a			12			
	Q2				21			
Discharge Time	Q1	t_b			11			
	Q2				19			
Reverse Recovery Charge	Q1	Q_{RR}			12		nC	
	Q2				40			

PACKAGE PARASITIC VALUES

Parameter	FET	Symbol	Test Condition	Min		Max		Unit
				Q1	Q2	Q1	Q2	
Source Inductance	Q1	L_S	$T_A = 25^\circ\text{C}$		0.38		nH	
	Q2				0.65			
Drain Inductance	Q1	L_D			0.054		nH	
	Q2				0.007			
Gate Inductance	Q1	L_G			1.5		nH	
	Q2				1.5			
Gate Resistance	Q1	R_G			0.8		Ω	
	Q2				0.8			

5. Pulse Test: pulse width $\leq 300\ \mu\text{s}$, duty cycle $\leq 2\%$.

6. Switching characteristics are independent of operating junction temperatures.

ORDERING INFORMATION

Device	Package	Shipping [†]
NTMFD4901NFT1G	DFN8 (Pb-Free)	1500 / Tape & Reel
NTMFD4901NFT3G	DFN8 (Pb-Free)	5000 / Tape & Reel

[†]For information on tape and reel specifications, including part orientation and tape sizes, please refer to our Tape and Reel Packaging Specifications Brochure, BRD8011/D.

TYPICAL CHARACTERISTICS – Q1

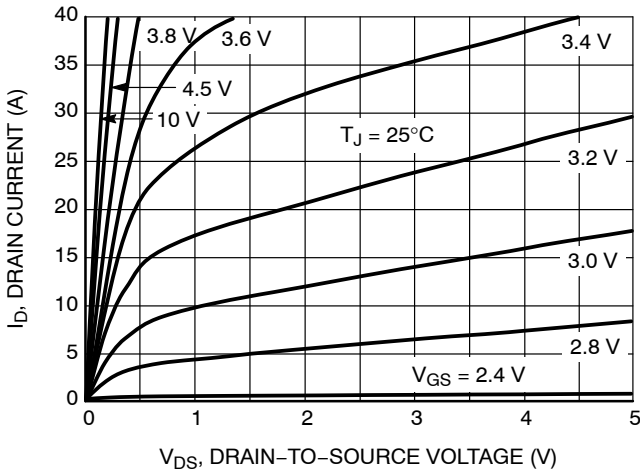

Figure 1. On-Region Characteristics

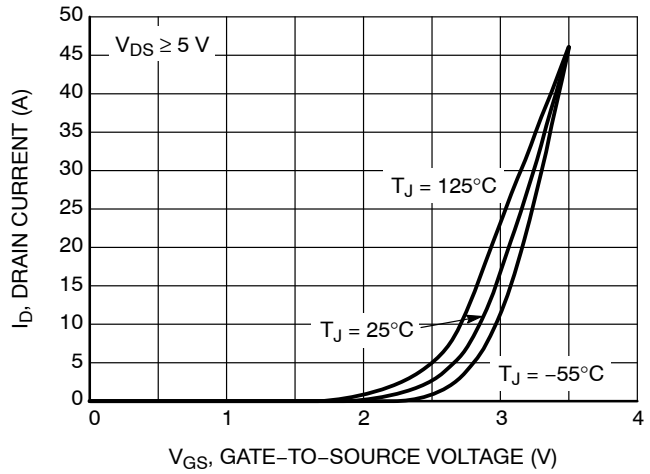

Figure 2. Transfer Characteristics

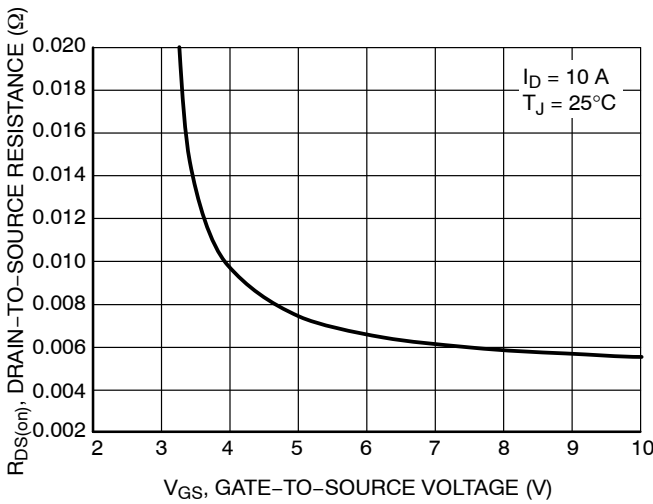

Figure 3. On-Resistance vs. Gate-to-Source Resistance

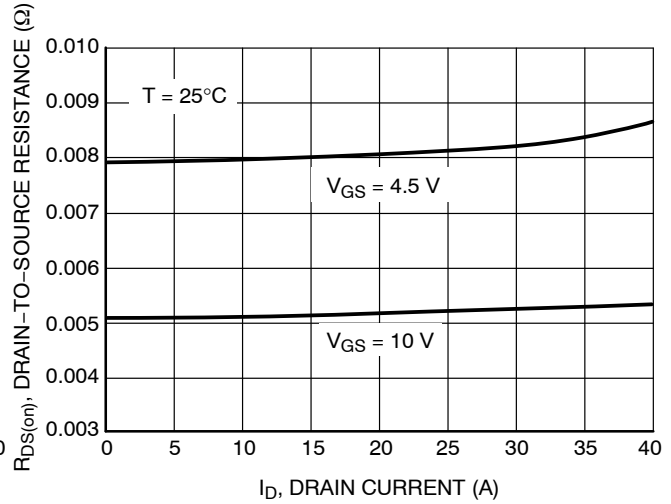

Figure 4. On-Resistance vs. Drain Current and Gate Voltage

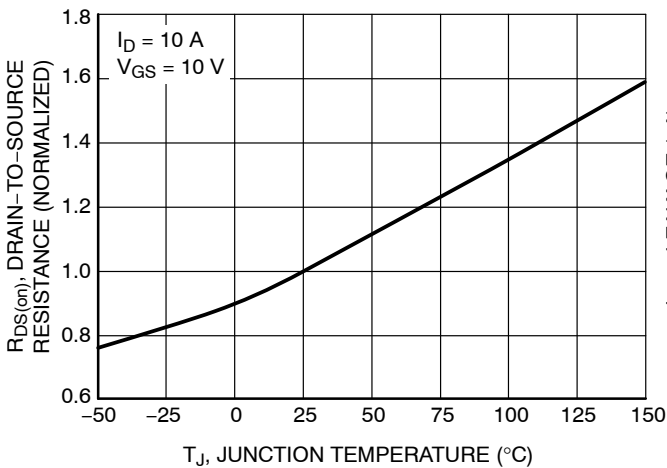

Figure 5. On-Resistance Variation with Temperature

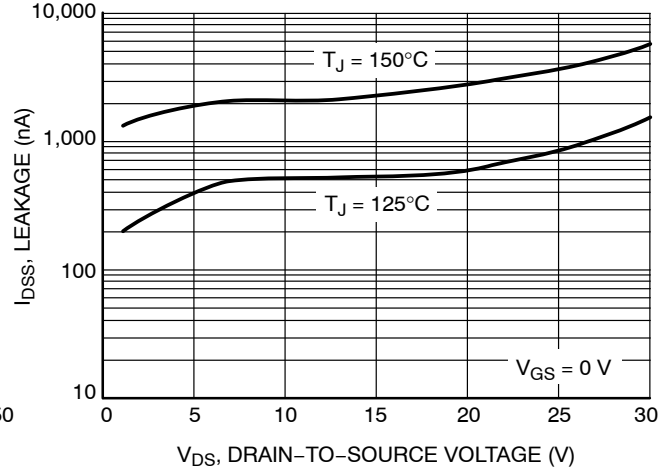

Figure 6. Drain-to-Source Leakage Current vs. Voltage

NTMFD4901NF

TYPICAL CHARACTERISTICS - Q1

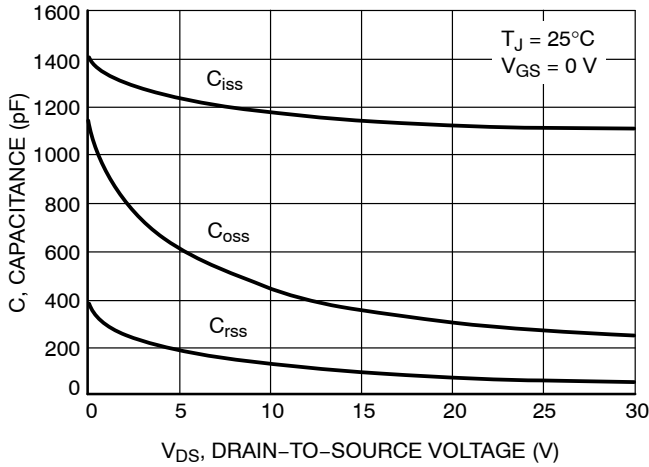

Figure 7. Capacitance Variation

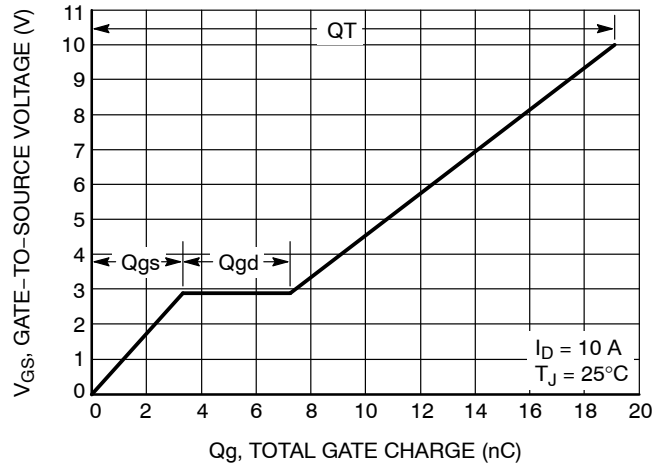

Figure 8. Gate-to-Source and Drain-to-Source Voltage vs. Total Charge

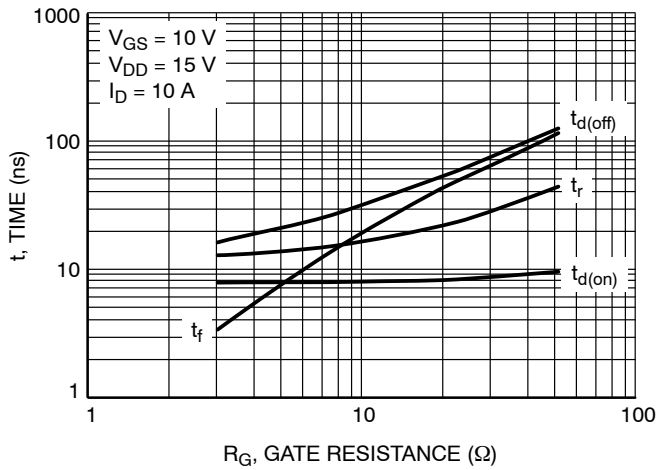

Figure 9. Resistive Switching Time Variation vs. Gate Resistance

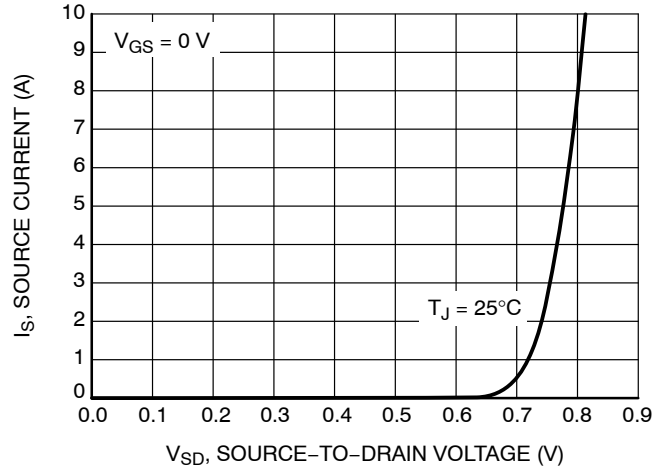

Figure 10. Diode Forward Voltage vs. Current

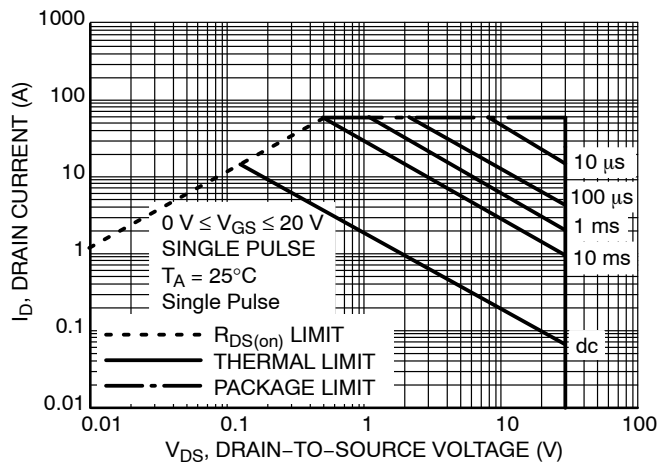

Figure 11. Maximum Rated Forward Biased Safe Operating Area

NTMFD4901NF

TYPICAL CHARACTERISTICS – Q1

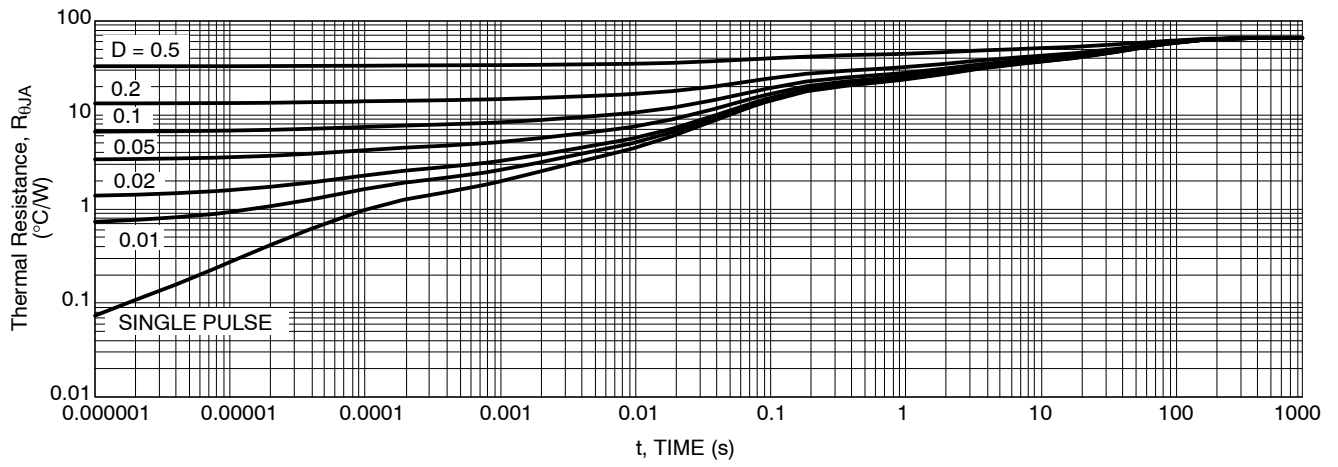

Figure 12. Thermal Response

TYPICAL CHARACTERISTICS – Q2

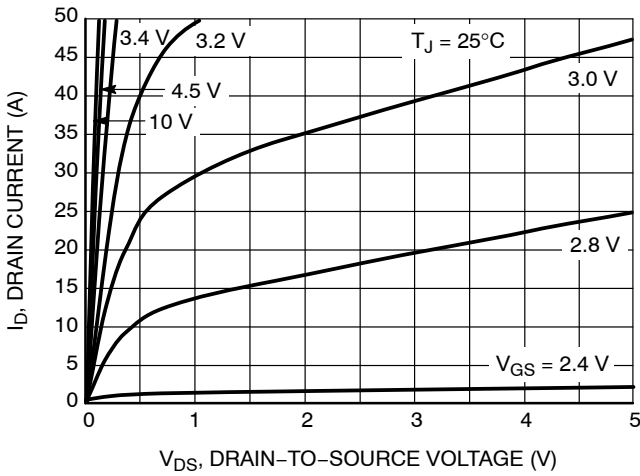

Figure 13. On-Region Characteristics

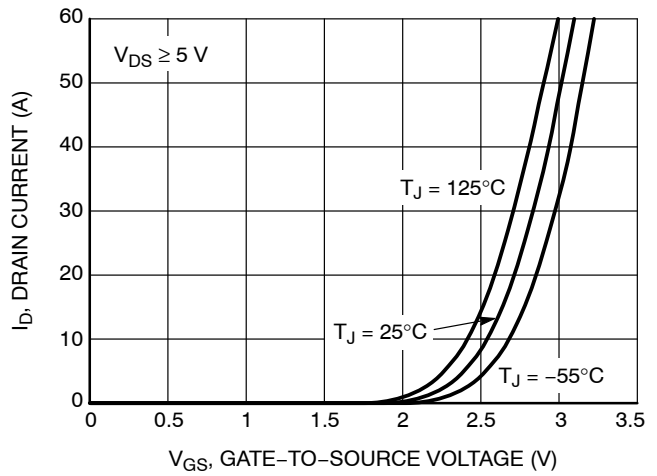

Figure 14. Transfer Characteristics

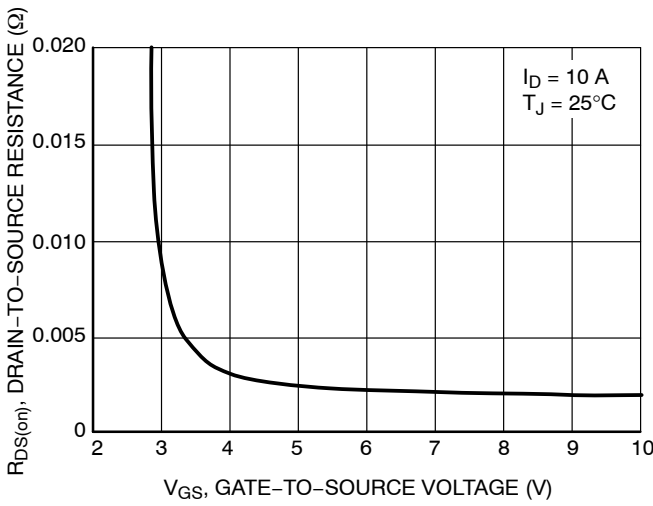

Figure 15. On-Resistance vs. Gate-to-Source Resistance

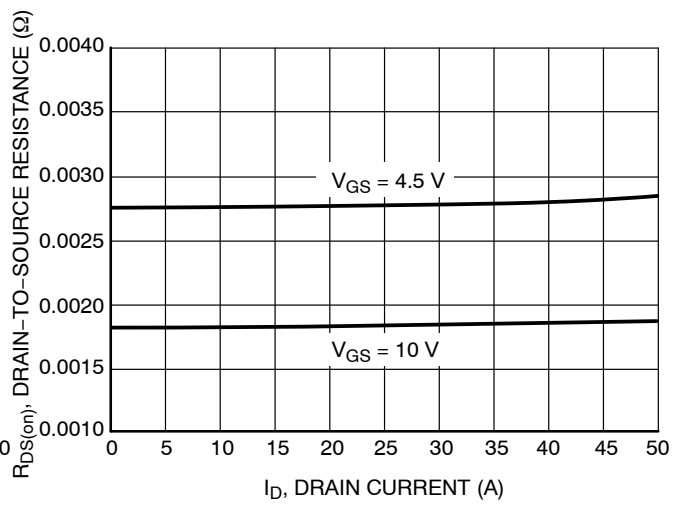

Figure 16. On-Resistance vs. Drain Current and Gate Voltage

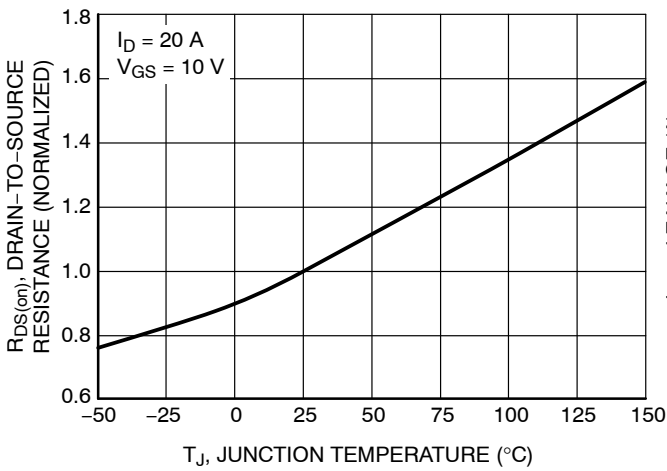

Figure 17. On-Resistance Variation with Temperature

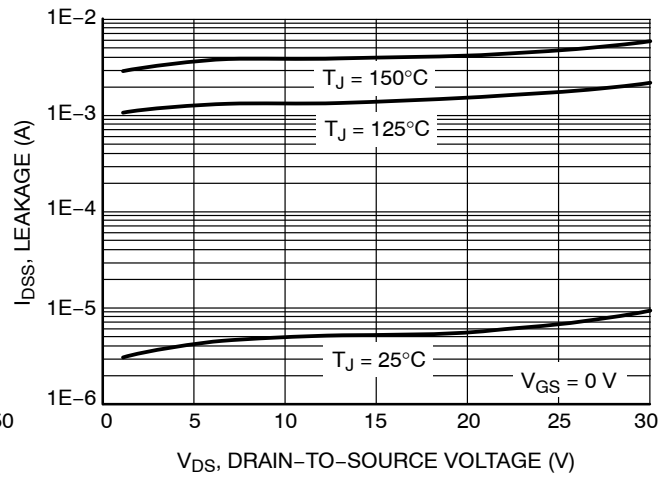

Figure 18. Drain-to-Source Leakage Current vs. Voltage

NTMFD4901NF

TYPICAL CHARACTERISTICS – Q2

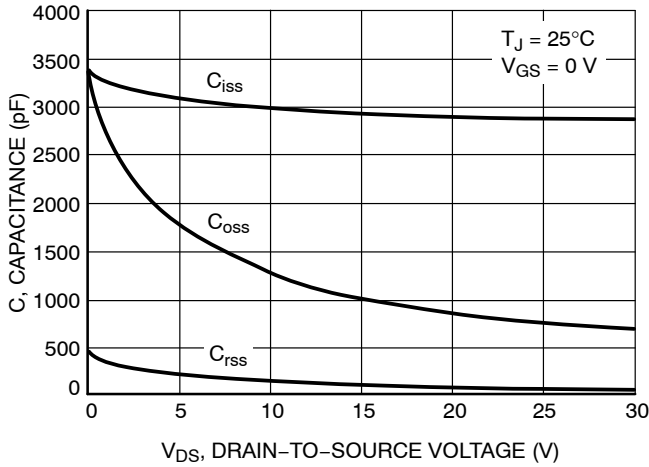

Figure 19. Capacitance Variation

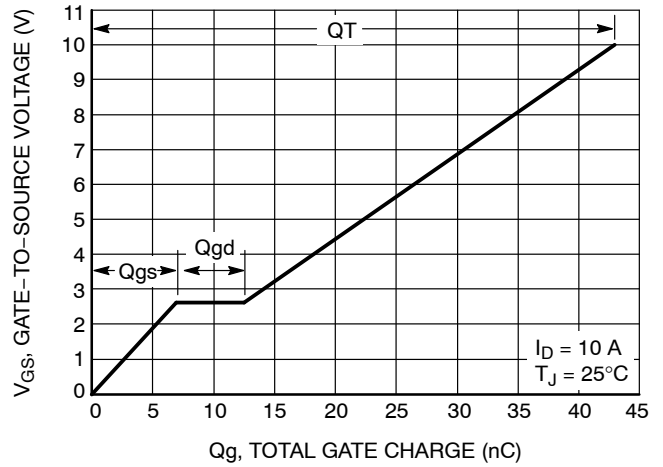

Figure 20. Gate-to-Source and Drain-to-Source Voltage vs. Total Charge

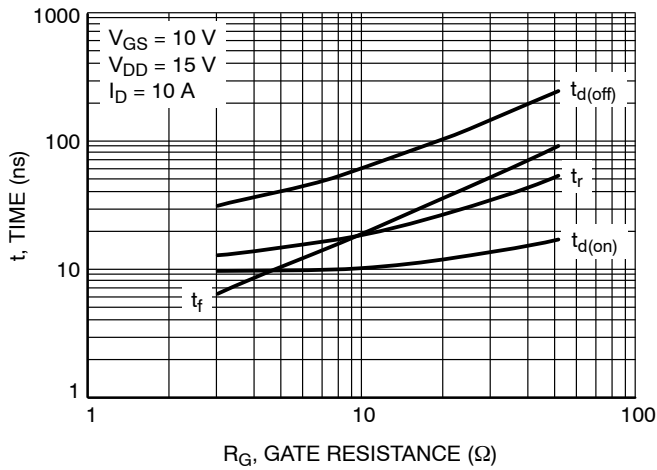

Figure 21. Resistive Switching Time Variation vs. Gate Resistance

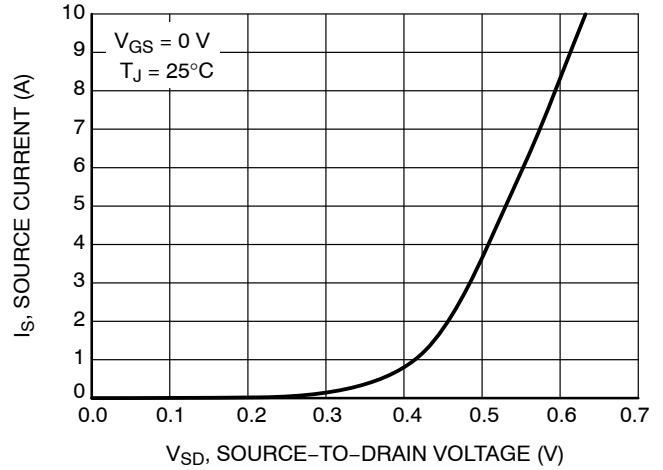

Figure 22. Diode Forward Voltage vs. Current

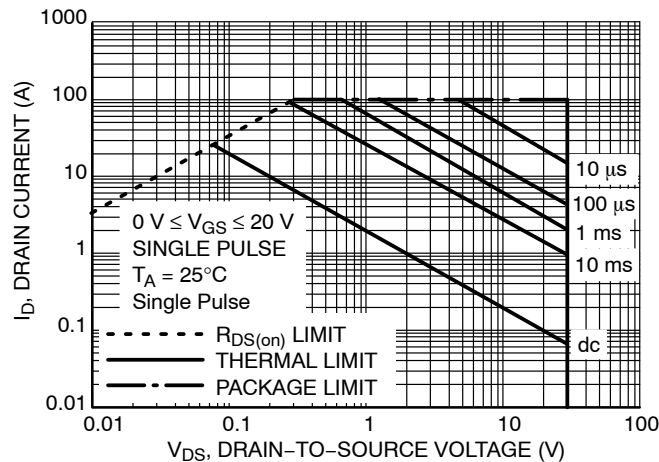

Figure 23. Maximum Rated Forward Biased Safe Operating Area

NTMFD4901NF

TYPICAL CHARACTERISTICS – Q2

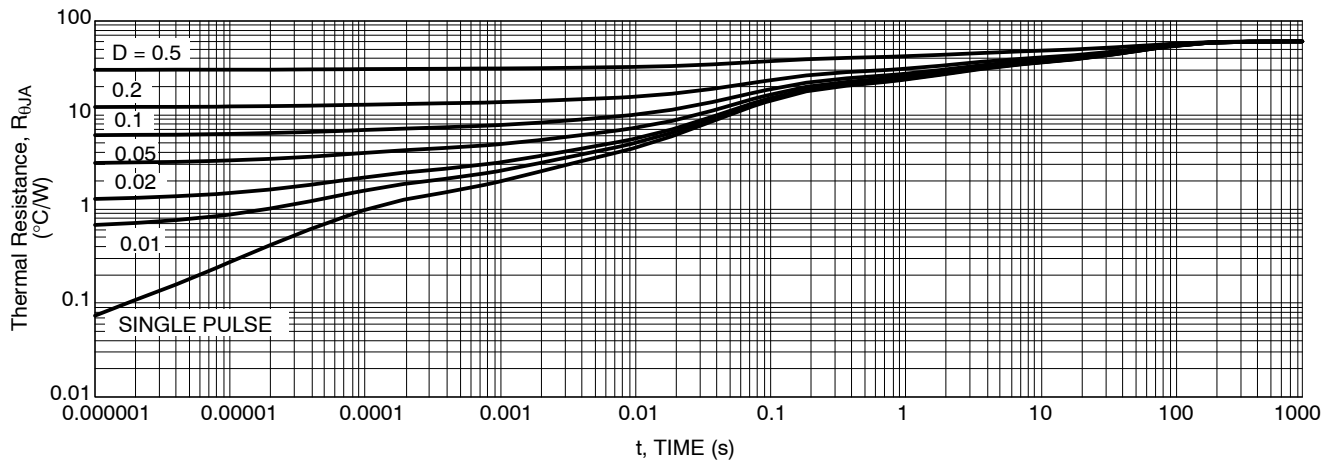
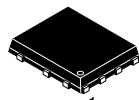

Figure 24. Thermal Response

MECHANICAL CASE OUTLINE

PACKAGE DIMENSIONS

ON Semiconductor®



SCALE 2:1

DFN8 5x6, 1.27P Dual Flag (SO8FL-Dual-Asymmetrical)

CASE 506BX
ISSUE D

DATE 24 JUN 2014

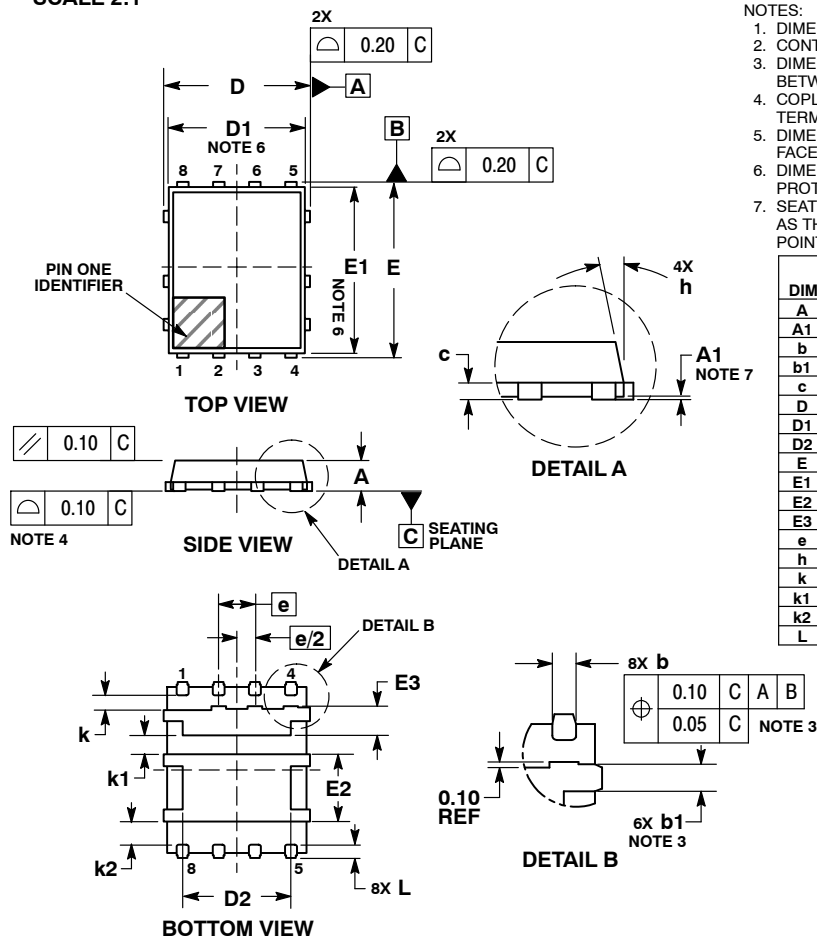

NOTES:

1. DIMENSIONING AND TOLERANCING PER ASME Y14.5M, 1994.
2. CONTROLLING DIMENSION: MILLIMETERS.
3. DIMENSION *b* APPLIES TO PLATED TERMINAL AND IS MEASURED BETWEEN 0.15 AND 0.25 MM FROM THE TERMINAL TIP.
4. COPLANARITY APPLIES TO THE EXPOSED PADS AS WELL AS THE TERMINALS.
5. DIMENSIONS *b* AND *L* ARE MEASURED AT THE PACKAGE SURFACE.
6. DIMENSIONS *D1* AND *E1* DO NOT INCLUDE MOLD FLASH, PROTRUSIONS, OR GATE BURRS.
7. SEATING PLANE IS DEFINED BY THE TERMINALS. *A1* IS DEFINED AS THE DISTANCE FROM THE SEATING PLANE TO THE LOWEST POINT ON THE PACKAGE BODY.

MILLIMETERS		
DIM	MIN	MAX
A	0.90	1.10
A1	0.00	0.05
<i>b</i>	0.41	0.61
<i>b1</i>	0.41	0.61
<i>c</i>	0.23	0.33
D	5.00	5.30
D1	4.50	5.10
D2	3.50	4.22
E	6.00	6.30
E1	5.50	6.10
E2	2.27	2.67
E3	0.82	1.22
<i>e</i>	1.27 BSC	
<i>h</i>	---	12 °
<i>k</i>	0.39	0.59
<i>k1</i>	0.56	0.76
<i>k2</i>	0.73	0.93
<i>L</i>	0.35	0.55

GENERIC MARKING DIAGRAM*

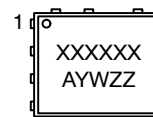

XXXXXX= Specific Device Code
 A = Assembly Location
 Y = Year
 W = Work Week
 ZZ = Lot Traceability

*This information is generic. Please refer to device data sheet for actual part marking.

RECOMMENDED SOLDERING FOOTPRINT*

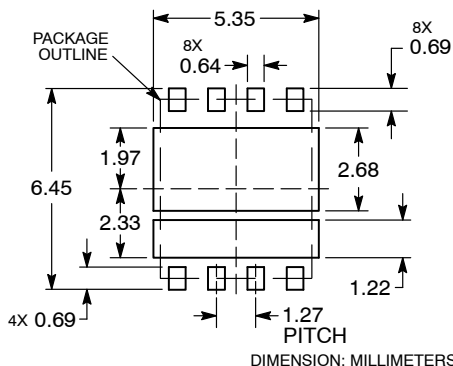

STYLE 1:

- PIN 1. GATE 1
 2. DRAIN 1
 3. DRAIN 1
 4. DRAIN 1
 5. SOURCE 2
 6. SOURCE 2
 7. SOURCE 2
 8. GATE 2
 9. DRAIN 1
 10. SOURCE 1/DRAIN 2

*For additional information on our Pb-Free strategy and soldering details, please download the ON Semiconductor Soldering and Mounting Techniques Reference Manual, SOLDERRM/D.

DOCUMENT NUMBER:	98AON54291E	Electronic versions are uncontrolled except when accessed directly from the Document Repository. Printed versions are uncontrolled except when stamped "CONTROLLED COPY" in red.
DESCRIPTION:	DFN8 5X6, 1.27P DUAL FLAG (SO8FL-DUAL-ASYMMETRICAL)	PAGE 1 OF 1

ON Semiconductor and are trademarks of Semiconductor Components Industries, LLC dba ON Semiconductor or its subsidiaries in the United States and/or other countries. ON Semiconductor reserves the right to make changes without further notice to any products herein. ON Semiconductor makes no warranty, representation or guarantee regarding the suitability of its products for any particular purpose, nor does ON Semiconductor assume any liability arising out of the application or use of any product or circuit, and specifically disclaims any and all liability, including without limitation special, consequential or incidental damages. ON Semiconductor does not convey any license under its patent rights nor the rights of others.

onsemi, **Onsemi**, and other names, marks, and brands are registered and/or common law trademarks of Semiconductor Components Industries, LLC dba "**onsemi**" or its affiliates and/or subsidiaries in the United States and/or other countries. **onsemi** owns the rights to a number of patents, trademarks, copyrights, trade secrets, and other intellectual property. A listing of **onsemi**'s product/patent coverage may be accessed at www.onsemi.com/site/pdf/Patent-Marking.pdf. **onsemi** reserves the right to make changes at any time to any products or information herein, without notice. The information herein is provided "as-is" and **onsemi** makes no warranty, representation or guarantee regarding the accuracy of the information, product features, availability, functionality, or suitability of its products for any particular purpose, nor does **onsemi** assume any liability arising out of the application or use of any product or circuit, and specifically disclaims any and all liability, including without limitation special, consequential or incidental damages. Buyer is responsible for its products and applications using **onsemi** products, including compliance with all laws, regulations and safety requirements or standards, regardless of any support or applications information provided by **onsemi**. "Typical" parameters which may be provided in **onsemi** data sheets and/or specifications can and do vary in different applications and actual performance may vary over time. All operating parameters, including "Typicals" must be validated for each customer application by customer's technical experts. **onsemi** does not convey any license under any of its intellectual property rights nor the rights of others. **onsemi** products are not designed, intended, or authorized for use as a critical component in life support systems or any FDA Class 3 medical devices or medical devices with a same or similar classification in a foreign jurisdiction or any devices intended for implantation in the human body. Should Buyer purchase or use **onsemi** products for any such unintended or unauthorized application, Buyer shall indemnify and hold **onsemi** and its officers, employees, subsidiaries, affiliates, and distributors harmless against all claims, costs, damages, and expenses, and reasonable attorney fees arising out of, directly or indirectly, any claim of personal injury or death associated with such unintended or unauthorized use, even if such claim alleges that **onsemi** was negligent regarding the design or manufacture of the part. **onsemi** is an Equal Opportunity/Affirmative Action Employer. This literature is subject to all applicable copyright laws and is not for resale in any manner.

ADDITIONAL INFORMATION

TECHNICAL PUBLICATIONS:

Technical Library: www.onsemi.com/design/resources/technical-documentation
onsemi Website: www.onsemi.com

ONLINE SUPPORT: www.onsemi.com/support

For additional information, please contact your local Sales Representative at www.onsemi.com/support/sales