

MOSFET – Power, Single, N-Channel

80 V, 5.5 mΩ, 89 A

NTMFS6D1N08H

Features

- Small Footprint (5x6 mm) for Compact Design
- Low $R_{DS(on)}$ to Minimize Conduction Losses
- Low Q_G and Capacitance to Minimize Driver Losses
- These Devices are Pb-Free, Halogen Free/BFR Free, Beryllium Free and are RoHS Compliant

Typical Applications

- Synchronous Rectification
- AC-DC and DC-DC Power Supplies
- AC-DC Adapters (USB PD) SR
- Load Switch

MAXIMUM RATINGS ($T_J = 25^\circ\text{C}$ unless otherwise noted)

Parameter		Symbol	Value	Unit	
Drain-to-Source Voltage		V_{DSS}	80	V	
Gate-to-Source Voltage		V_{GS}	± 20	V	
Continuous Drain Current $R_{\theta JC}$ (Note 1)	Steady State	$T_C = 25^\circ\text{C}$	I_D	89	A
			P_D	104	W
Continuous Drain Current $R_{\theta JA}$ (Notes 1, 2)	Steady State	$T_A = 25^\circ\text{C}$	I_D	17	A
			P_D	3.8	W
Pulsed Drain Current		$T_A = 25^\circ\text{C}, t_p = 10 \mu\text{s}$	I_{DM}	468	A
Operating Junction and Storage Temperature Range		T_J, T_{stg}	-55 to +175	$^\circ\text{C}$	
Source Current (Body Diode)		I_S	87	A	
Single Pulse Drain-to-Source Avalanche Energy ($I_{AV} = 5.9 \text{ A}$)		E_{AS}	465	mJ	
Lead Temperature Soldering Reflow for Soldering Purposes (1/8" from case for 10 s)		T_L	300	$^\circ\text{C}$	

Stresses exceeding those listed in the Maximum Ratings table may damage the device. If any of these limits are exceeded, device functionality should not be assumed, damage may occur and reliability may be affected.

THERMAL RESISTANCE RATINGS

Parameter	Symbol	Value	Unit
Junction-to-Case – Steady State (Note 1)	$R_{\theta JC}$	1.44	$^\circ\text{C}/\text{W}$
Junction-to-Ambient – Steady State (Note 1)	$R_{\theta JA}$	40	

1. The entire application environment impacts the thermal resistance values shown, they are not constants and are only valid for the particular conditions noted.
2. Surface-mounted on FR4 board using 1 in² pad size, 1 oz. Cu pad.

$V_{(BR)DSS}$	$R_{DS(ON)} \text{ MAX}$	$I_D \text{ MAX}$
80 V	5.5 mΩ @ 10 V	89 A
	8.0 mΩ @ 6 V	

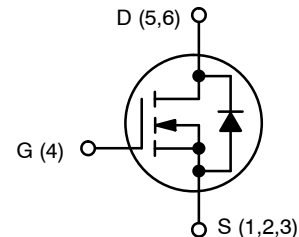

N-CHANNEL MOSFET

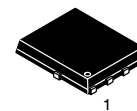

DFN5
(SO-8FL)
CASE 488AA
STYLE 1

MARKING DIAGRAM

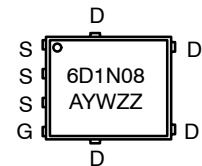

- A = Assembly Location
- Y = Year
- W = Work Week
- ZZ = Lot Traceability

ORDERING INFORMATION

Device	Package	Shipping†
NTMFS6D1N08HT1G	DFN5 (Pb-Free)	1500 / Tape & Reel

†For information on tape and reel specifications, including part orientation and tape sizes, please refer to our Tape and Reel Packaging Specification Brochure, BRD8011/D.

NTMFS6D1N08H

ELECTRICAL CHARACTERISTICS ($T_J = 25^\circ\text{C}$ unless otherwise specified)

Parameter	Symbol	Test Condition	Min	Typ	Max	Unit
OFF CHARACTERISTICS						
Drain-to-Source Breakdown Voltage	$V_{(BR)DSS}$	$V_{GS} = 0\text{ V}, I_D = 250\ \mu\text{A}$	80			V
Drain-to-Source Breakdown Voltage Temperature Coefficient	$V_{(BR)DSS}/T_J$	$I_D = 250\ \mu\text{A}$, ref to 25°C		43.8		mV/ $^\circ\text{C}$
Zero Gate Voltage Drain Current	I_{DSS}	$V_{GS} = 0\text{ V}, V_{DS} = 80\text{ V}$	$T_J = 25^\circ\text{C}$		10	μA
			$T_J = 125^\circ\text{C}$		100	
Gate-to-Source Leakage Current	I_{GSS}	$V_{DS} = 0\text{ V}, V_{GS} = 20\text{ V}$			100	nA

ON CHARACTERISTICS (Note 3)

Gate Threshold Voltage	$V_{GS(TH)}$	$V_{GS} = V_{DS}, I_D = 120\ \mu\text{A}$	2.0		4.0	V
Threshold Temperature Coefficient	$V_{GS(TH)}/T_J$	$I_D = 250\ \mu\text{A}$, ref to 25°C		-7.08		mV/ $^\circ\text{C}$
Drain-to-Source On Resistance	$R_{DS(on)}$	$V_{GS} = 10\text{ V}, I_D = 20\text{ A}$		4.5	5.5	$\text{m}\Omega$
		$V_{GS} = 6\text{ V}, I_D = 10\text{ A}$		6.4	8.0	
Forward Transconductance	g_{FS}	$V_{DS} = 15\text{ V}, I_D = 20\text{ A}$		80		S
Gate-Resistance	R_G	$T_A = 25^\circ\text{C}$		1.0		Ω

CHARGES & CAPACITANCES

Input Capacitance	C_{ISS}	$V_{GS} = 0\text{ V}, f = 1\text{ MHz}, V_{DS} = 40\text{ V}$		2085		pF
Output Capacitance	C_{OSS}			300		
Reverse Transfer Capacitance	C_{RSS}			10		
Total Gate Charge	$Q_{G(TOT)}$	$V_{GS} = 6\text{ V}, V_{DS} = 40\text{ V}, I_D = 30\text{ A}$		10		nC
Total Gate Charge	$Q_{G(TOT)}$	$V_{GS} = 10\text{ V}, V_{DS} = 40\text{ V}, I_D = 30\text{ A}$		32		nC
Gate-to-Source Charge	Q_{GS}			10		
Gate-to-Drain Charge	Q_{GD}			6		
Plateau Voltage	V_{GP}			5		

SWITCHING CHARACTERISTICS (Note 3)

Turn-On Delay Time	$t_{d(ON)}$	$V_{GS} = 10\text{ V}, V_{DS} = 64\text{ V}, I_D = 30\text{ A}, R_G = 2.5\ \Omega$		18		ns
Rise Time	t_r			50		
Turn-Off Delay Time	$t_{d(OFF)}$			48		
Fall Time	t_f			39		

DRAIN-SOURCE DIODE CHARACTERISTICS

Forward Diode Voltage	V_{SD}	$V_{GS} = 0\text{ V}, I_S = 20\text{ A}$	$T_J = 25^\circ\text{C}$		0.8	1.2	V
			$T_J = 125^\circ\text{C}$		0.7		
Reverse Recovery Time	t_{RR}	$V_{GS} = 0\text{ V}, di_S/dt = 100\text{ A}/\mu\text{s}, I_S = 20\text{ A}$		49		ns	
Reverse Recovery Charge	Q_{RR}			60		nC	
Charge Time	t_a	$V_{GS} = 0\text{ V}, di_S/dt = 100\text{ A}/\mu\text{s}, I_S = 20\text{ A}$		30		ns	
Discharge Time	t_b			19		ns	

Product parametric performance is indicated in the Electrical Characteristics for the listed test conditions, unless otherwise noted. Product performance may not be indicated by the Electrical Characteristics if operated under different conditions.

3. Switching characteristics are independent of operating junction temperatures

4. $R_{\theta JA}$ is determined with the device mounted on a 1 in² pad 2 oz copper pad on a 1.5 × 1.5 in. board of FR-4 material. $R_{\theta JC}$ is guaranteed by design while $R_{\theta CA}$ is determined by the user's board design.

NTMFS6D1N08H

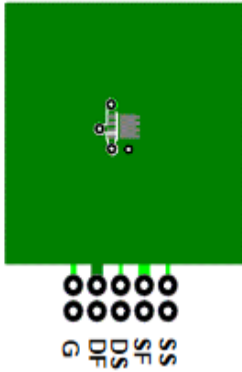

a) 53°C/W when mounted on a 1 in² pad of 2 oz copper.



b) 125°C/W when mounted on a minimum pad of 2 oz copper.

5. Pulse Test: pulse width < 300 μ s, duty cycle < 2%.
6. E_{AS} of 465 mJ is based on started $T_J = 25^\circ\text{C}$, $I_{AS} = 5.9$ A, $V_{DD} = 80$ V, $V_{GS} = 10$ V. 100% test at $I_{AS} = 8.4$ A.
7. As an N-ch device, the negative V_{GS} rating is for low duty cycle pulse occurrence only. No continuous rating is implied.

NTMFS6D1N08H

TYPICAL CHARACTERISTICS

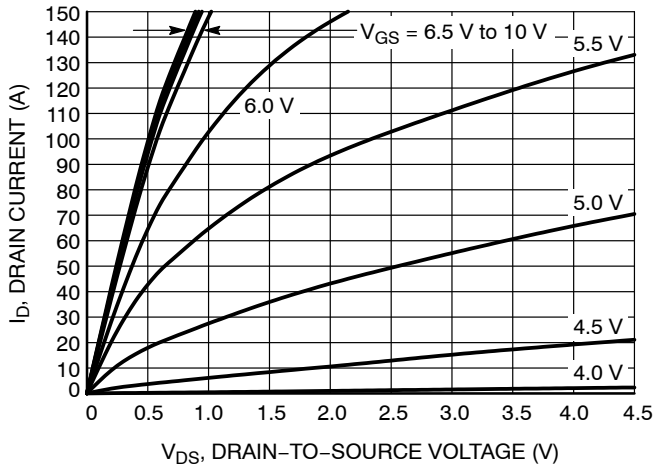

Figure 1. On-Region Characteristics

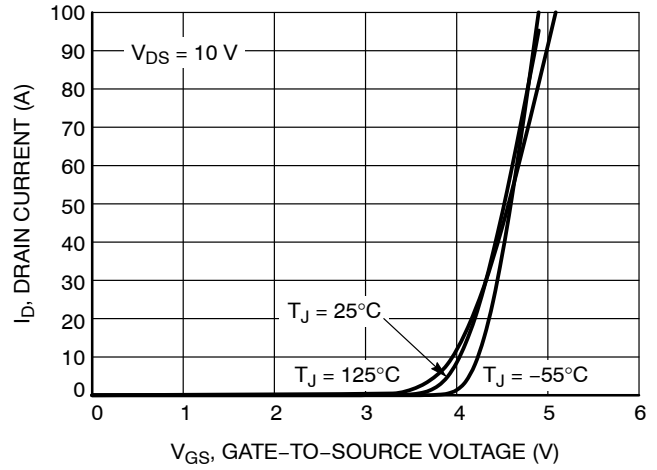

Figure 2. Transfer Characteristics

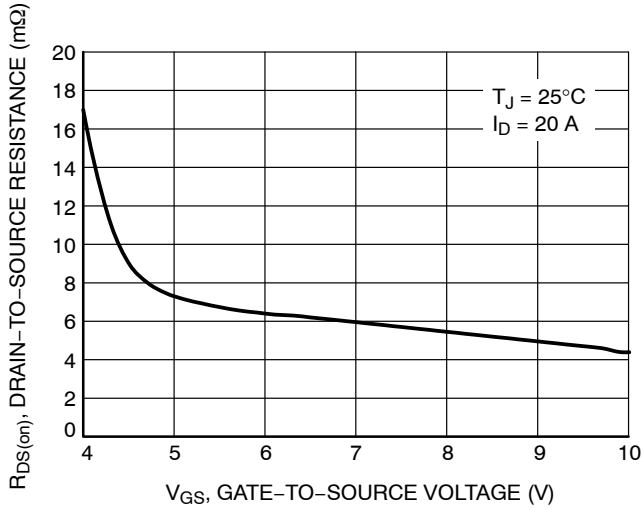

Figure 3. On-Resistance vs. Gate-to-Source Voltage

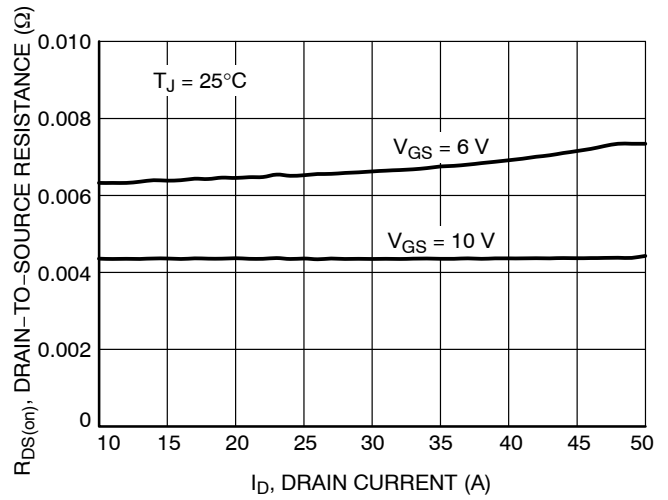

Figure 4. On-Resistance vs. Drain Current and Gate Voltage

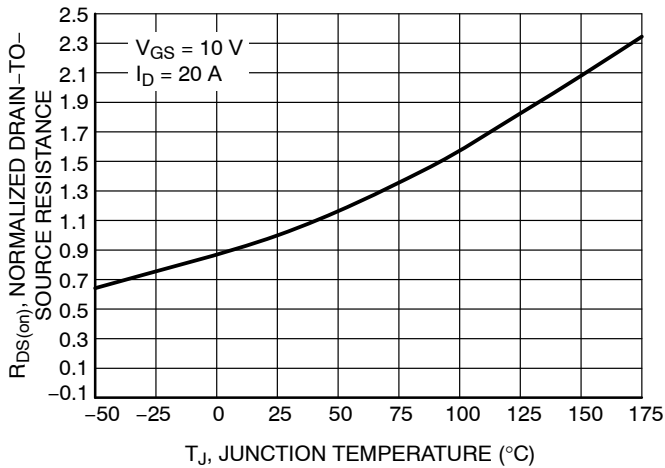

Figure 5. On-Resistance Variation with Temperature

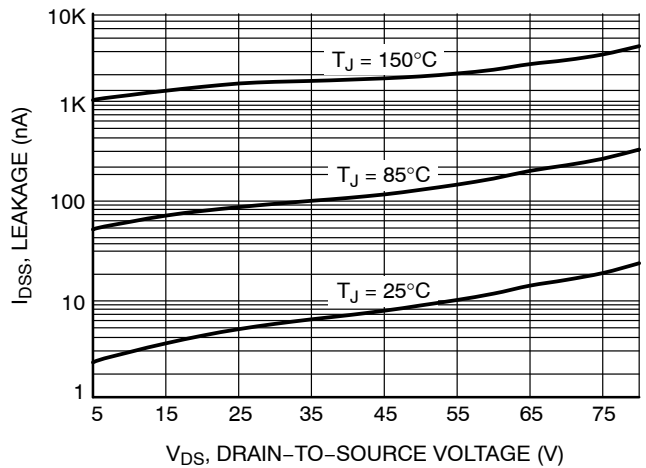

Figure 6. Drain-to-Source Leakage Current vs. Voltage

NTMFS6D1N08H

TYPICAL CHARACTERISTICS

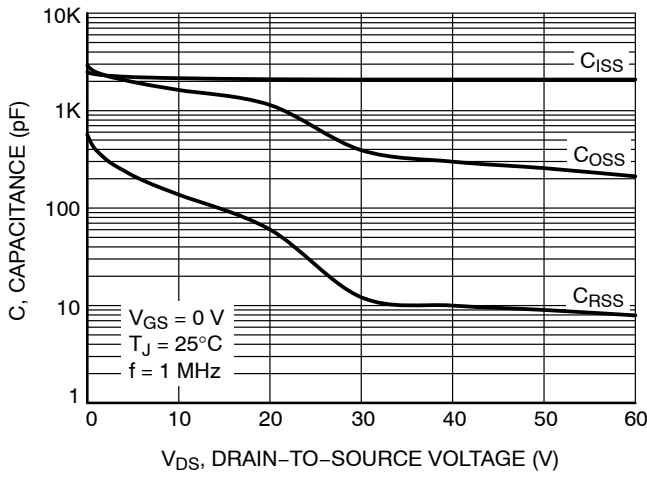

Figure 7. Capacitance Variation

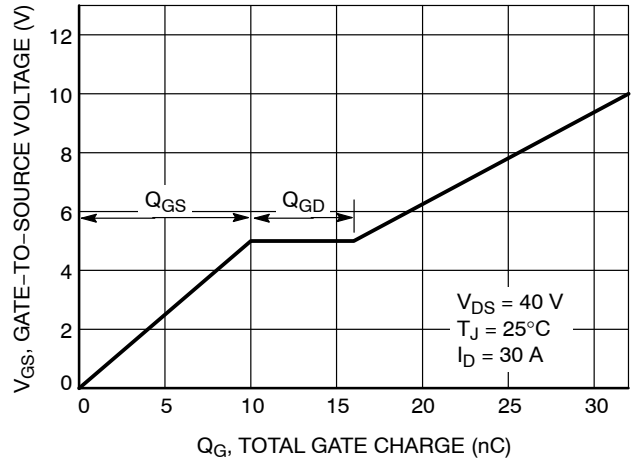

Figure 8. Gate-to-Source Voltage vs. Total Charge

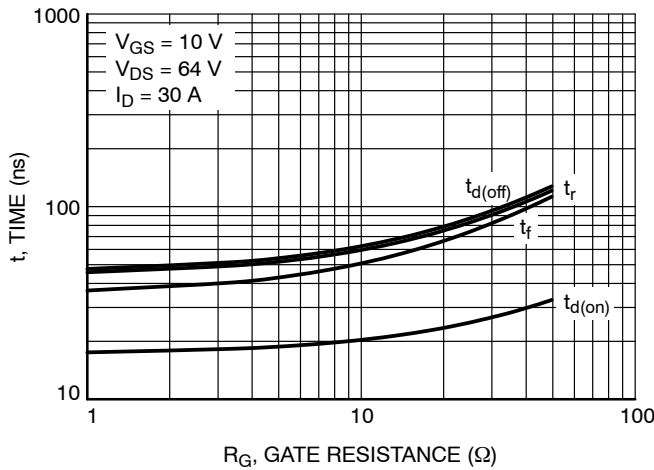

Figure 9. Resistive Switching Time Variation vs. Gate Resistance

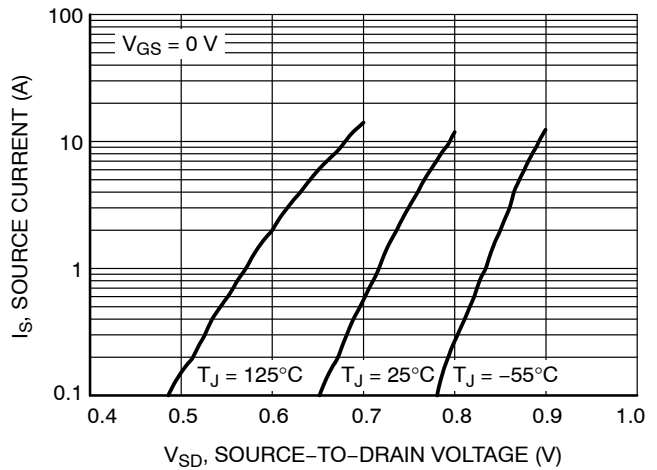

Figure 10. Diode Forward Voltage vs. Current

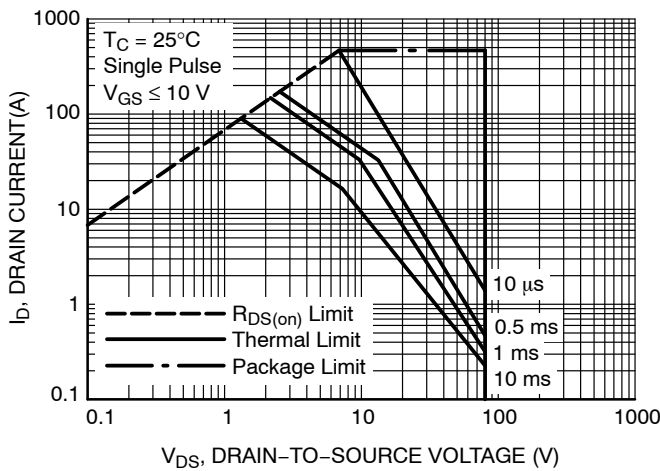

Figure 11. Maximum Rated Forward Biased Safe Operating Area

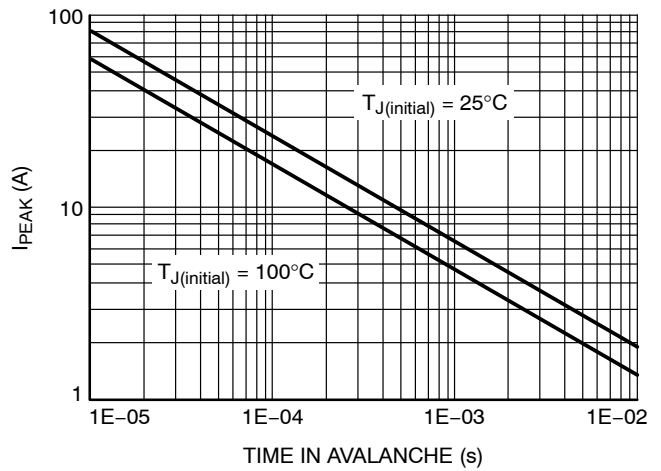

Figure 12. I_{PEAK} vs. Time in Avalanche

NTMFS6D1N08H

TYPICAL CHARACTERISTICS

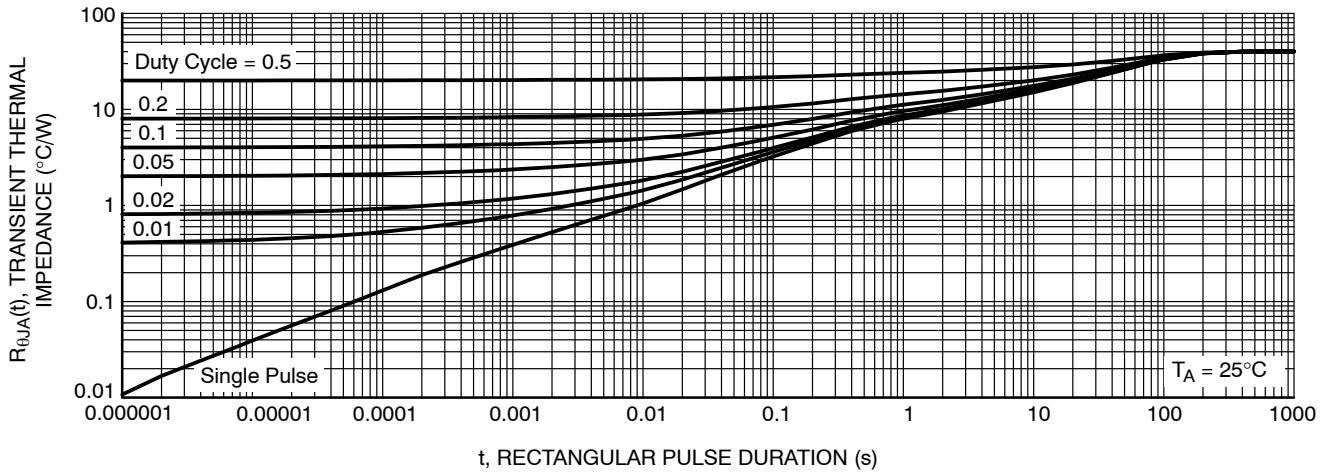

Figure 13. Thermal Response

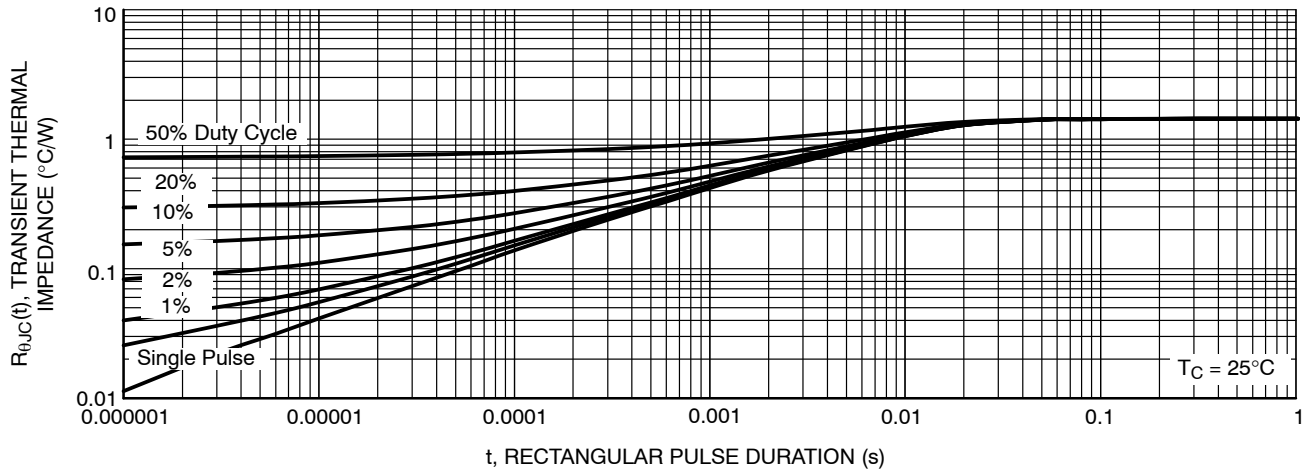

Figure 14. Thermal Response

MECHANICAL CASE OUTLINE

PACKAGE DIMENSIONS



1
SCALE 2:1

DFN5 5x6, 1.27P
(SO-8FL)
CASE 488AA
ISSUE N

DATE 25 JUN 2018



NOTES:

1. DIMENSIONING AND TOLERANCING PER ASME Y14.5M, 1994.
2. CONTROLLING DIMENSION: MILLIMETER.
3. DIMENSION D1 AND E1 DO NOT INCLUDE MOLD FLASH PROTRUSIONS OR GATE BURRS.

MILLIMETERS			
DIM	MIN	NOM	MAX
A	0.90	1.00	1.10
A1	0.00	---	0.05
b	0.33	0.41	0.51
c	0.23	0.28	0.33
D	5.00	5.15	5.30
D1	4.70	4.90	5.10
D2	3.80	4.00	4.20
E	6.00	6.15	6.30
E1	5.70	5.90	6.10
E2	3.45	3.65	3.85
e	1.27 BSC		
G	0.51	0.575	0.71
K	1.20	1.35	1.50
L	0.51	0.575	0.71
L1	0.125 REF		
M	3.00	3.40	3.80
θ	0°	---	12°

GENERIC MARKING DIAGRAM*



- XXXXXX = Specific Device Code
- A = Assembly Location
- Y = Year
- W = Work Week
- ZZ = Lot Traceability

*This information is generic. Please refer to device data sheet for actual part marking. Pb-Free indicator, "G" or microdot "•", may or may not be present. Some products may not follow the Generic Marking.



STYLE 1:
PIN 1. SOURCE
2. SOURCE
3. SOURCE
4. GATE
5. DRAIN

STYLE 2:
PIN 1. ANODE
2. ANODE
3. ANODE
4. NO CONNECT
5. CATHODE

DIMENSIONS: MILLIMETERS

*For additional information on our Pb-Free strategy and soldering details, please download the ON Semiconductor Soldering and Mounting Techniques Reference Manual, SOLDERRM/D.

DOCUMENT NUMBER:	98AON14036D	Electronic versions are uncontrolled except when accessed directly from the Document Repository. Printed versions are uncontrolled except when stamped "CONTROLLED COPY" in red.
DESCRIPTION:	DFN5 5x6, 1.27P (SO-8FL)	PAGE 1 OF 1

onsemi and ONSEMI are trademarks of Semiconductor Components Industries, LLC dba onsemi or its subsidiaries in the United States and/or other countries. onsemi reserves the right to make changes without further notice to any products herein. onsemi makes no warranty, representation or guarantee regarding the suitability of its products for any particular purpose, nor does onsemi assume any liability arising out of the application or use of any product or circuit, and specifically disclaims any and all liability, including without limitation special, consequential or incidental damages. onsemi does not convey any license under its patent rights nor the rights of others.

onsemi, **Onsemi**, and other names, marks, and brands are registered and/or common law trademarks of Semiconductor Components Industries, LLC dba "**onsemi**" or its affiliates and/or subsidiaries in the United States and/or other countries. **onsemi** owns the rights to a number of patents, trademarks, copyrights, trade secrets, and other intellectual property. A listing of **onsemi**'s product/patent coverage may be accessed at www.onsemi.com/site/pdf/Patent-Marking.pdf. **onsemi** reserves the right to make changes at any time to any products or information herein, without notice. The information herein is provided "as-is" and **onsemi** makes no warranty, representation or guarantee regarding the accuracy of the information, product features, availability, functionality, or suitability of its products for any particular purpose, nor does **onsemi** assume any liability arising out of the application or use of any product or circuit, and specifically disclaims any and all liability, including without limitation special, consequential or incidental damages. Buyer is responsible for its products and applications using **onsemi** products, including compliance with all laws, regulations and safety requirements or standards, regardless of any support or applications information provided by **onsemi**. "Typical" parameters which may be provided in **onsemi** data sheets and/or specifications can and do vary in different applications and actual performance may vary over time. All operating parameters, including "Typicals" must be validated for each customer application by customer's technical experts. **onsemi** does not convey any license under any of its intellectual property rights nor the rights of others. **onsemi** products are not designed, intended, or authorized for use as a critical component in life support systems or any FDA Class 3 medical devices or medical devices with a same or similar classification in a foreign jurisdiction or any devices intended for implantation in the human body. Should Buyer purchase or use **onsemi** products for any such unintended or unauthorized application, Buyer shall indemnify and hold **onsemi** and its officers, employees, subsidiaries, affiliates, and distributors harmless against all claims, costs, damages, and expenses, and reasonable attorney fees arising out of, directly or indirectly, any claim of personal injury or death associated with such unintended or unauthorized use, even if such claim alleges that **onsemi** was negligent regarding the design or manufacture of the part. **onsemi** is an Equal Opportunity/Affirmative Action Employer. This literature is subject to all applicable copyright laws and is not for resale in any manner.

ADDITIONAL INFORMATION

TECHNICAL PUBLICATIONS:

Technical Library: www.onsemi.com/design/resources/technical-documentation
onsemi Website: www.onsemi.com

ONLINE SUPPORT: www.onsemi.com/support

For additional information, please contact your local Sales Representative at www.onsemi.com/support/sales

