

MOSFET - Power, Single N-Channel, μ 8FL

30 V, 17 m Ω , 22 A

NVTFS4C25N

Features

- Low $R_{DS(on)}$ to Minimize Conduction Losses
- Low Capacitance to Minimize Driver Losses
- Optimized Gate Charge to Minimize Switching Losses
- NVTFS4C25NWF – Wettable Flanks Product
- NVT Prefix for Automotive and Other Applications Requiring Unique Site and Control Change Requirements; AEC-Q101 Qualified and PPAP Capable
- These Devices are Pb-Free, Halogen Free/BFR Free and are RoHS Compliant

MAXIMUM RATINGS ($T_J = 25^\circ\text{C}$ unless otherwise stated)

Parameter	Symbol	Value	Unit	
Drain-to-Source Voltage	V_{DSS}	30	V	
Gate-to-Source Voltage	V_{GS}	± 20	V	
Continuous Drain Current $R_{\theta JA}$ (Notes 1, 3, 5)	Steady State	$T_A = 25^\circ\text{C}$	I_D 10.1	A
		$T_A = 85^\circ\text{C}$	7.8	
Power Dissipation $R_{\theta JA}$ (Notes 1, 3, 5)		$T_A = 25^\circ\text{C}$	P_D 3.0	W
		$T_A = 85^\circ\text{C}$	1.8	
Continuous Drain Current $R_{\theta JC}$ (Notes 1, 2, 4, 5)	Steady State	$T_C = 25^\circ\text{C}$	I_D 22.1	A
		$T_C = 85^\circ\text{C}$	17.1	
Power Dissipation $R_{\theta JC}$ (Notes 1, 2, 4, 5)		$T_C = 25^\circ\text{C}$	P_D 14.3	W
		$T_C = 85^\circ\text{C}$	8.6	
Pulsed Drain Current	$T_A = 25^\circ\text{C}, t_p = 10 \mu\text{s}$	I_{DM} 90	A	
Operating Junction and Storage Temperature	T_J, T_{stg}	-55 to +175	$^\circ\text{C}$	
Source Current (Body Diode)	I_S	14	A	
Single Pulse Drain-to-Source Avalanche Energy ($T_J = 25^\circ\text{C}, I_L = 6.7 A_{pk}, L = 0.5 \text{ mH}$)	E_{AS}	11.2	mJ	
Lead Temperature for Soldering Purposes (1/8" from case for 10 s)	T_L	260	$^\circ\text{C}$	

Stresses exceeding those listed in the Maximum Ratings table may damage the device. If any of these limits are exceeded, device functionality should not be assumed, damage may occur and reliability may be affected.

1. The entire application environment impacts the thermal resistance values shown; they are not constants and are valid for the specific conditions noted.
2. Psi (ψ) is used as required per JESD51-12 for packages in which substantially less than 100% of the heat flows to a single case surface.
3. Surface-mounted on FR4 board using 650 mm², 2 oz. Cu Pad.
4. Assumes heat-sink sufficiently large to maintain constant case temperature independent of device power.
5. Continuous DC current rating. Maximum current for pulses as long as one second is higher but dependent on pulse duration and duty cycle.

$V_{(BR)DSS}$	$R_{DS(on)}$ MAX	I_D MAX
30 V	17 m Ω @ 10 V	22 A
	26.5 m Ω @ 4.5 V	

N-Channel MOSFET

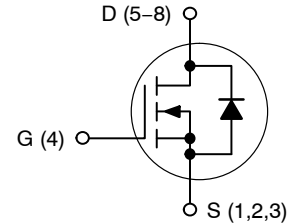

MARKING DIAGRAM

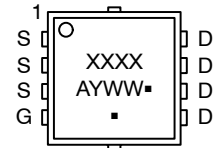

- 4C25 = Specific Device Code for NVMTS4C25N
- 25WF = Specific Device Code of NVTFS4C25NWF
- A = Assembly Location
- Y = Year
- WW = Work Week
- = Pb-Free Package

(Note: Microdot may be in either location)

ORDERING INFORMATION

See detailed ordering and shipping information on page 6 of this data sheet.

NVTFS4C25N

THERMAL RESISTANCE MAXIMUM RATINGS

Parameter	Symbol	Value	Unit
Junction-to-Case (Drain) (Notes 6, 7 and 9)	$\Psi_{\theta JC}$	10.5	°C/W
Junction-to-Ambient – Steady State (Notes 6 and 8)	$R_{\theta JA}$	50	

- The entire application environment impacts the thermal resistance values shown; they are not constants and are valid for the specific conditions noted.
- Psi (ψ) is used as required per JESD51-12 for packages in which substantially less than 100% of the heat flows to a single case surface.
- Surface-mounted on FR4 board using 650 mm², 2 oz. Cu Pad.
- Assumes heat-sink sufficiently large to maintain constant case temperature independent of device power.

ELECTRICAL CHARACTERISTICS (T_J = 25°C unless otherwise specified)

Parameter	Symbol	Test Condition	Min	Typ	Max	Unit
OFF CHARACTERISTICS						
Drain-to-Source Breakdown Voltage	$V_{(BR)DSS}$	$V_{GS} = 0 V, I_D = 250 \mu A$	30			V
Drain-to-Source Breakdown Voltage Temperature Coefficient	$V_{(BR)DSS}/T_J$			15.3		mV/°C
Zero Gate Voltage Drain Current	I_{DSS}	$V_{GS} = 0 V, V_{DS} = 24 V$			1.0	μA
		$T_J = 125^\circ C$			10	
Gate-to-Source Leakage Current	I_{GSS}	$V_{DS} = 0 V, V_{GS} = \pm 20 V$			± 100	nA

ON CHARACTERISTICS (Note 10)

Gate Threshold Voltage	$V_{GS(TH)}$	$V_{GS} = V_{DS}, I_D = 250 \mu A$	1.3		2.2	V
Threshold Temperature Coefficient	$V_{GS(TH)}/T_J$			-4.5		mV/°C
Drain-to-Source On Resistance	$R_{DS(on)}$	$V_{GS} = 10 V, I_D = 10 A$ $V_{GS} = 4.5 V, I_D = 9 A$		13	17	m Ω
				21	26.5	
Forward Transconductance	g_{FS}	$V_{DS} = 1.5 V, I_D = 15 A$		23		S
Gate Resistance	R_G	$T_A = 25^\circ C$		1.0		Ω

CHARGES AND CAPACITANCES

Input Capacitance	C_{ISS}	$V_{GS} = 0 V, f = 1 MHz, V_{DS} = 15 V$		500		pF
Output Capacitance	C_{OSS}			295		
Reverse Transfer Capacitance	C_{RSS}			85		
Capacitance Ratio	C_{RSS}/C_{ISS}	$V_{GS} = 0 V, V_{DS} = 15 V, f = 1 MHz$		0.170		
Total Gate Charge	$Q_{G(TOT)}$	$V_{GS} = 4.5 V, V_{DS} = 15 V; I_D = 20 A$		5.1		nC
Threshold Gate Charge	$Q_{G(TH)}$			0.9		
Gate-to-Source Charge	Q_{GS}			1.7		
Gate-to-Drain Charge	Q_{GD}			2.7		
Gate Plateau Voltage	V_{GP}			3.3		V
Total Gate Charge	$Q_{G(TOT)}$	$V_{GS} = 10 V, V_{DS} = 15 V; I_D = 20 A$		10.3		nC

SWITCHING CHARACTERISTICS (Note 11)

Turn-On Delay Time	$t_{d(ON)}$	$V_{GS} = 4.5 V, V_{DS} = 15 V, I_D = 10 A, R_G = 3.0 \Omega$		8.0		ns
Rise Time	t_r			32		
Turn-Off Delay Time	$t_{d(OFF)}$			10		
Fall Time	t_f			3.0		
Turn-On Delay Time	$t_{d(ON)}$	$V_{GS} = 10 V, V_{DS} = 15 V, I_D = 15 A, R_G = 3.0 \Omega$		4.0		ns
Rise Time	t_r			25		
Turn-Off Delay Time	$t_{d(OFF)}$			13		
Fall Time	t_f			2.0		

- Pulse Test: pulse width $\leq 300 \mu s$, duty cycle $\leq 2\%$.
- Switching characteristics are independent of operating junction temperatures.

NVTFS4C25N

ELECTRICAL CHARACTERISTICS ($T_J = 25^\circ\text{C}$ unless otherwise specified)

Parameter	Symbol	Test Condition	Min	Typ	Max	Unit	
DRAIN-SOURCE DIODE CHARACTERISTICS							
Forward Diode Voltage	V_{SD}	$V_{GS} = 0\text{ V},$ $I_S = 10\text{ A}$	$T_J = 25^\circ\text{C}$		0.87	1.2	V
			$T_J = 125^\circ\text{C}$		0.75		
Reverse Recovery Time	t_{RR}	$V_{GS} = 0\text{ V}, dI_S/dt = 100\text{ A}/\mu\text{s},$ $I_S = 30\text{ A}$		18.2		ns	
Charge Time	t_a			9.8			
Discharge Time	t_b			8.4			
Reverse Recovery Charge	Q_{RR}			5.7			nC

10. Pulse Test: pulse width $\leq 300\ \mu\text{s}$, duty cycle $\leq 2\%$.

11. Switching characteristics are independent of operating junction temperatures.

NVTFS4C25N

TYPICAL CHARACTERISTICS

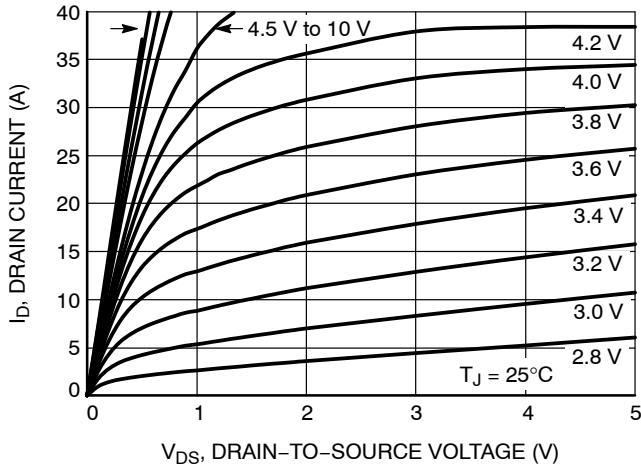

Figure 1. On-Region Characteristics

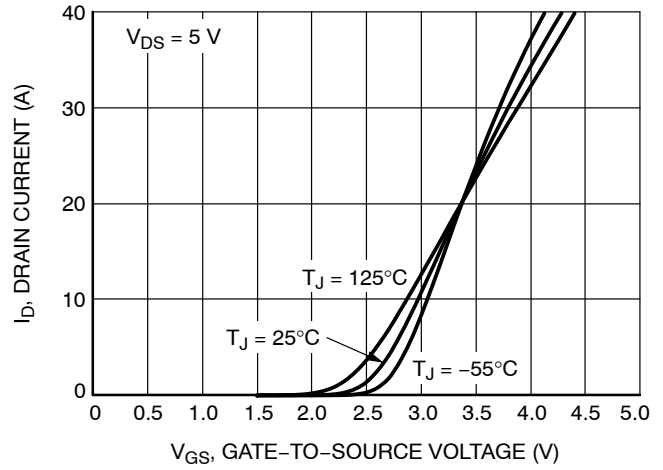

Figure 2. Transfer Characteristics

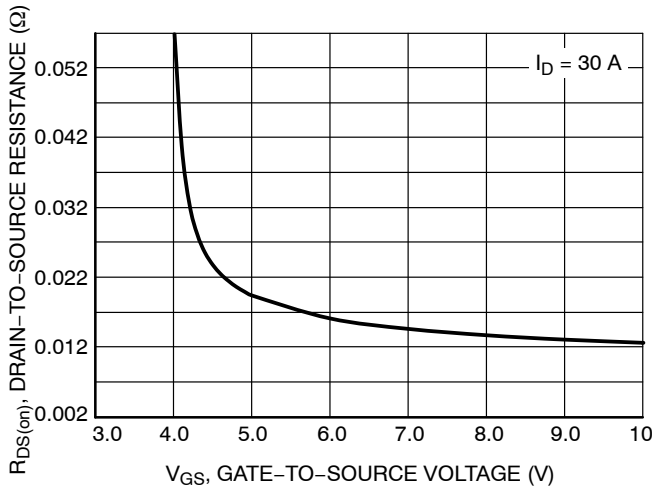

Figure 3. On-Resistance vs. V_{GS}

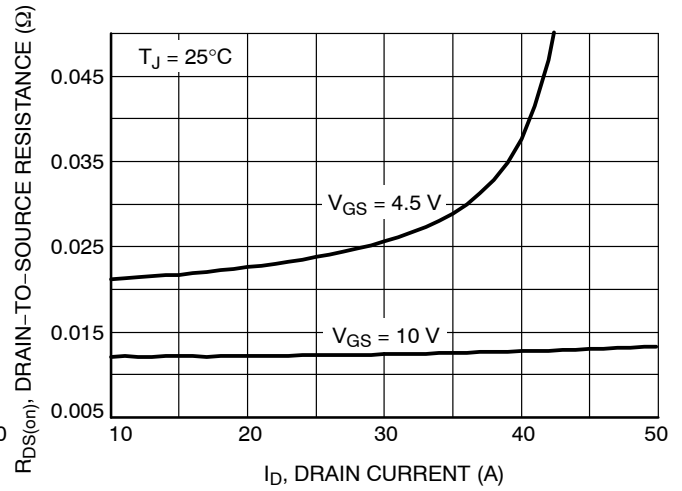

Figure 4. On-Resistance vs. Drain Current and Gate Voltage

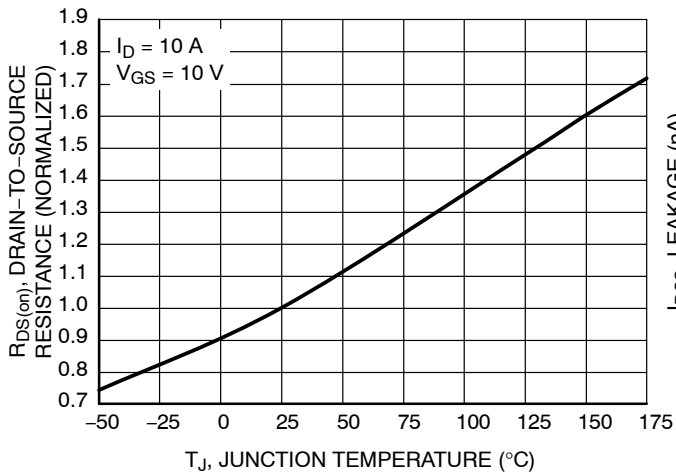

Figure 5. On-Resistance Variation with Temperature

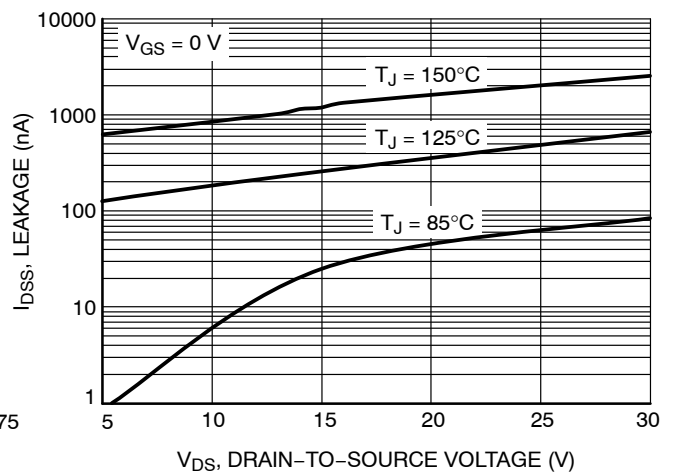

Figure 6. Drain-to-Source Leakage Current vs. Voltage

NVTFS4C25N

TYPICAL CHARACTERISTICS

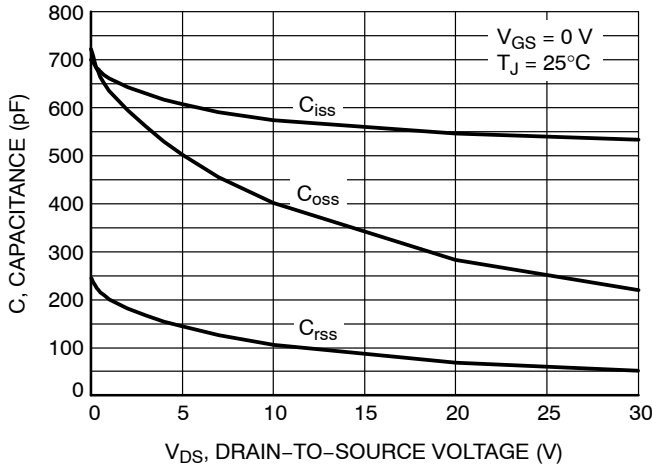

Figure 7. Capacitance Variation

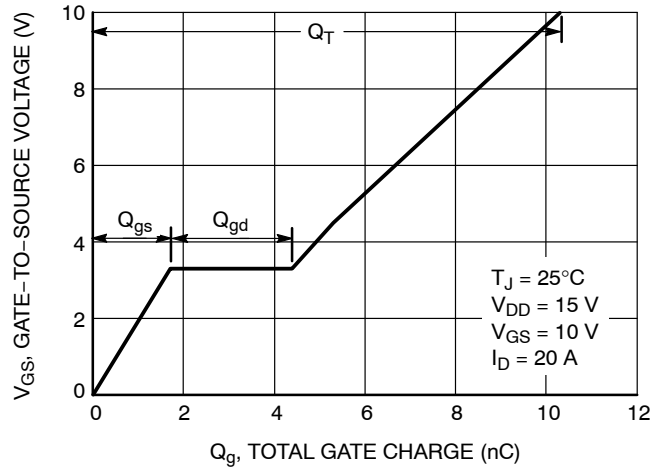

Figure 8. Gate-to-Source and Drain-to-Source Voltage vs. Total Charge

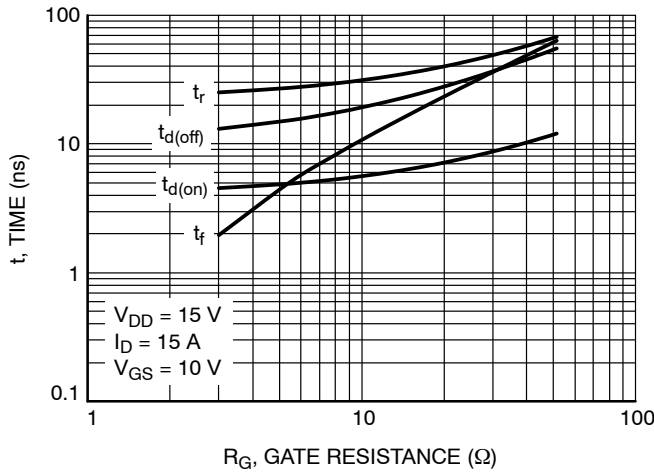

Figure 9. Resistive Switching Time Variation vs. Gate Resistance

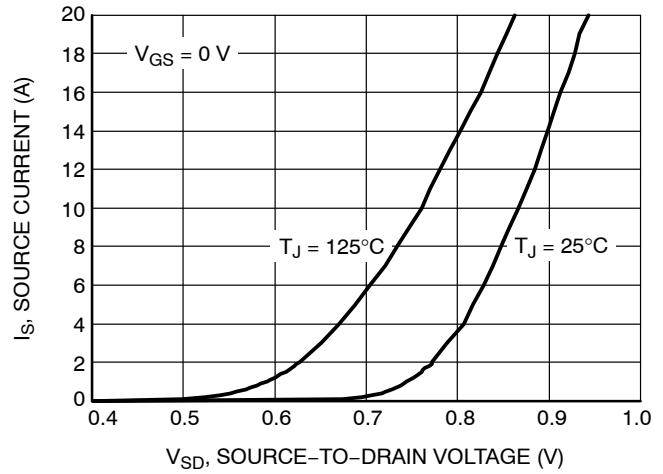

Figure 10. Diode Forward Voltage vs. Current

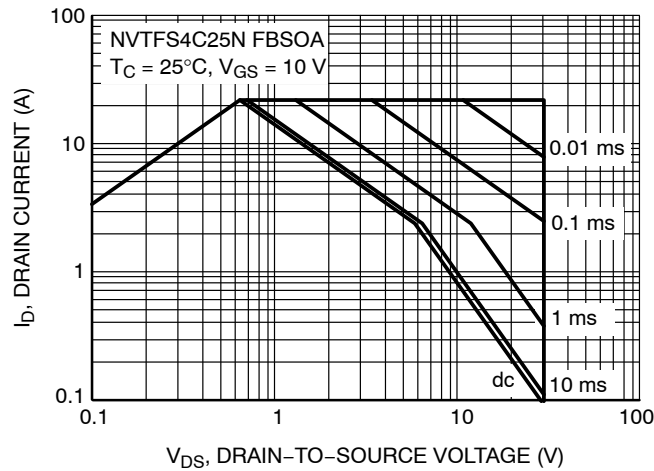

Figure 11. Maximum Rated Forward Biased Safe Operating Area

NVTFS4C25N

TYPICAL CHARACTERISTICS

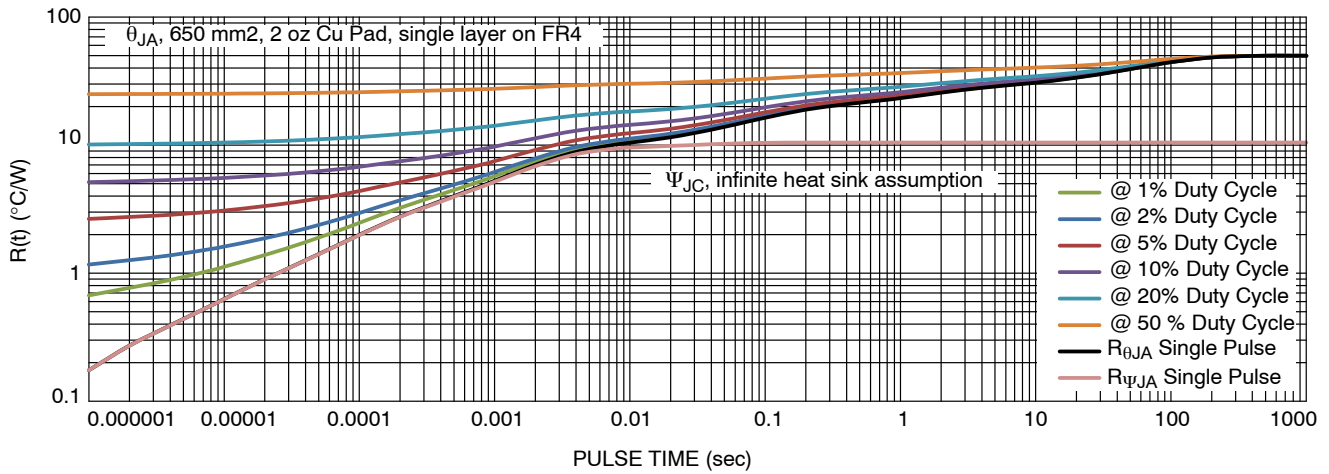

Figure 12. Thermal Response

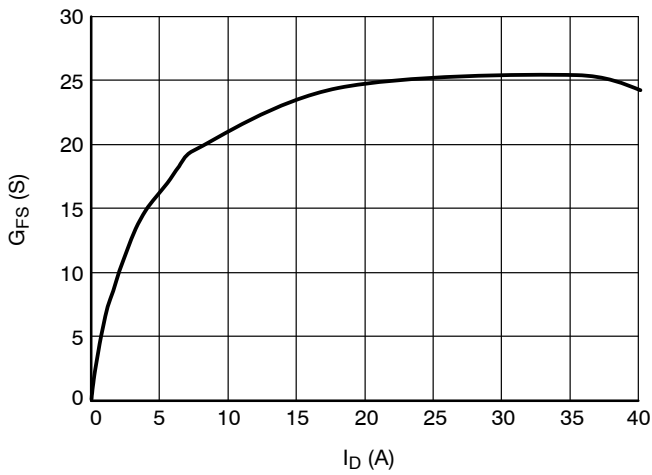

Figure 13. G_{FS} vs. I_D

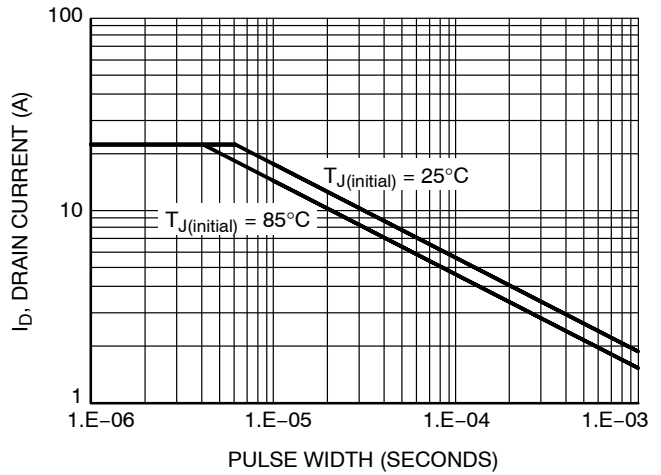

Figure 14. Avalanche Characteristics

ORDERING INFORMATION

Device	Marking	Package	Shipping [†]
NVTFS4C25NTAG	4C25	WDFN8 (Pb-Free)	1500 / Tape & Reel
NVTFS4C25NWFTAG	25WF	WDFN8 (Pb-Free)	1500 / Tape & Reel

[†]For information on tape and reel specifications, including part orientation and tape sizes, please refer to our Tape and Reel Packaging Specifications Brochure, BRD8011/D.



SCALE 2:1

WDFN8 3.3x3.3, 0.65P
CASE 511AB
ISSUE D

DATE 23 APR 2012

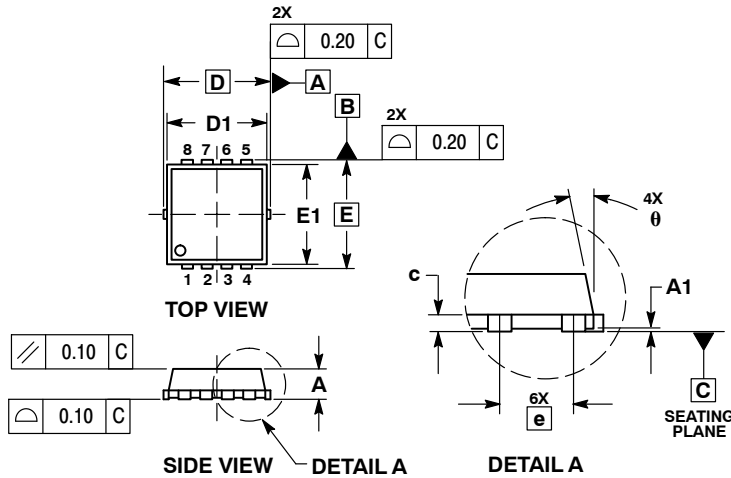

NOTES:

1. DIMENSIONING AND TOLERANCING PER ASME Y14.5M, 1994.
2. CONTROLLING DIMENSION: MILLIMETERS.
3. DIMENSION D1 AND E1 DO NOT INCLUDE MOLD FLASH PROTRUSIONS OR GATE BURRS.

DIM	MILLIMETERS			INCHES		
	MIN	NOM	MAX	MIN	NOM	MAX
A	0.70	0.75	0.80	0.028	0.030	0.031
A1	0.00	---	0.05	0.000	---	0.002
b	0.23	0.30	0.40	0.009	0.012	0.016
c	0.15	0.20	0.25	0.006	0.008	0.010
D	3.30 BSC			0.130 BSC		
D1	2.95	3.05	3.15	0.116	0.120	0.124
D2	1.98	2.11	2.24	0.078	0.083	0.088
E	3.30 BSC			0.130 BSC		
E1	2.95	3.05	3.15	0.116	0.120	0.124
E2	1.47	1.60	1.73	0.058	0.063	0.068
E3	0.23	0.30	0.40	0.009	0.012	0.016
e	0.65 BSC			0.026 BSC		
G	0.30	0.41	0.51	0.012	0.016	0.020
K	0.65	0.80	0.95	0.026	0.032	0.037
L	0.30	0.43	0.56	0.012	0.017	0.022
L1	0.06	0.13	0.20	0.002	0.005	0.008
M	1.40	1.50	1.60	0.055	0.059	0.063
θ	0 °	---	12 °	0 °	---	12 °

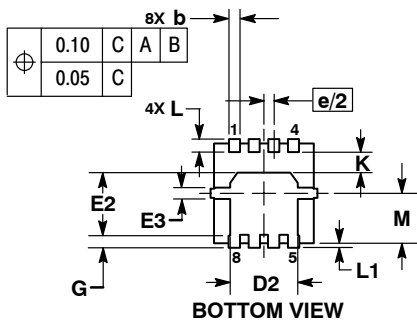

GENERIC MARKING DIAGRAM*

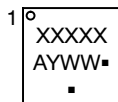

- XXXXX = Specific Device Code
- A = Assembly Location
- Y = Year
- WW = Work Week
- = Pb-Free Package

*This information is generic. Please refer to device data sheet for actual part marking. Pb-Free indicator, "G" or microdot "▪", may or may not be present. Some products may not follow the Generic Marking.

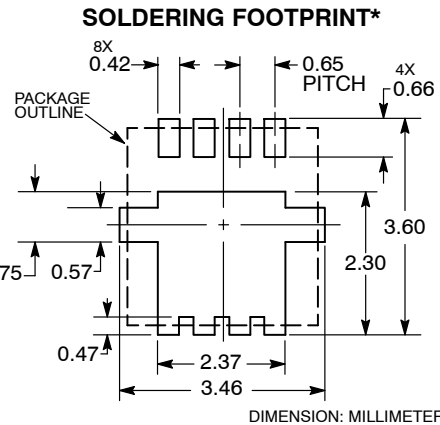

*For additional information on our Pb-Free strategy and soldering details, please download the onsemi Soldering and Mounting Techniques Reference Manual, SOLDERRM/D.

DOCUMENT NUMBER:	98AON30561E	Electronic versions are uncontrolled except when accessed directly from the Document Repository. Printed versions are uncontrolled except when stamped "CONTROLLED COPY" in red.
DESCRIPTION:	WDFN8 3.3X3.3, 0.65P	PAGE 1 OF 1

onsemi and onsemi are trademarks of Semiconductor Components Industries, LLC dba onsemi or its subsidiaries in the United States and/or other countries. onsemi reserves the right to make changes without further notice to any products herein. onsemi makes no warranty, representation or guarantee regarding the suitability of its products for any particular purpose, nor does onsemi assume any liability arising out of the application or use of any product or circuit, and specifically disclaims any and all liability, including without limitation special, consequential or incidental damages. onsemi does not convey any license under its patent rights nor the rights of others.

onsemi, **Onsemi**, and other names, marks, and brands are registered and/or common law trademarks of Semiconductor Components Industries, LLC dba "**onsemi**" or its affiliates and/or subsidiaries in the United States and/or other countries. **onsemi** owns the rights to a number of patents, trademarks, copyrights, trade secrets, and other intellectual property. A listing of **onsemi**'s product/patent coverage may be accessed at www.onsemi.com/site/pdf/Patent-Marking.pdf. **onsemi** reserves the right to make changes at any time to any products or information herein, without notice. The information herein is provided "as-is" and **onsemi** makes no warranty, representation or guarantee regarding the accuracy of the information, product features, availability, functionality, or suitability of its products for any particular purpose, nor does **onsemi** assume any liability arising out of the application or use of any product or circuit, and specifically disclaims any and all liability, including without limitation special, consequential or incidental damages. Buyer is responsible for its products and applications using **onsemi** products, including compliance with all laws, regulations and safety requirements or standards, regardless of any support or applications information provided by **onsemi**. "Typical" parameters which may be provided in **onsemi** data sheets and/or specifications can and do vary in different applications and actual performance may vary over time. All operating parameters, including "Typicals" must be validated for each customer application by customer's technical experts. **onsemi** does not convey any license under any of its intellectual property rights nor the rights of others. **onsemi** products are not designed, intended, or authorized for use as a critical component in life support systems or any FDA Class 3 medical devices or medical devices with a same or similar classification in a foreign jurisdiction or any devices intended for implantation in the human body. Should Buyer purchase or use **onsemi** products for any such unintended or unauthorized application, Buyer shall indemnify and hold **onsemi** and its officers, employees, subsidiaries, affiliates, and distributors harmless against all claims, costs, damages, and expenses, and reasonable attorney fees arising out of, directly or indirectly, any claim of personal injury or death associated with such unintended or unauthorized use, even if such claim alleges that **onsemi** was negligent regarding the design or manufacture of the part. **onsemi** is an Equal Opportunity/Affirmative Action Employer. This literature is subject to all applicable copyright laws and is not for resale in any manner.

ADDITIONAL INFORMATION

TECHNICAL PUBLICATIONS:

Technical Library: www.onsemi.com/design/resources/technical-documentation
onsemi Website: www.onsemi.com

ONLINE SUPPORT: www.onsemi.com/support

For additional information, please contact your local Sales Representative at www.onsemi.com/support/sales